

ELECTROSURGERY.
COMPLETE.

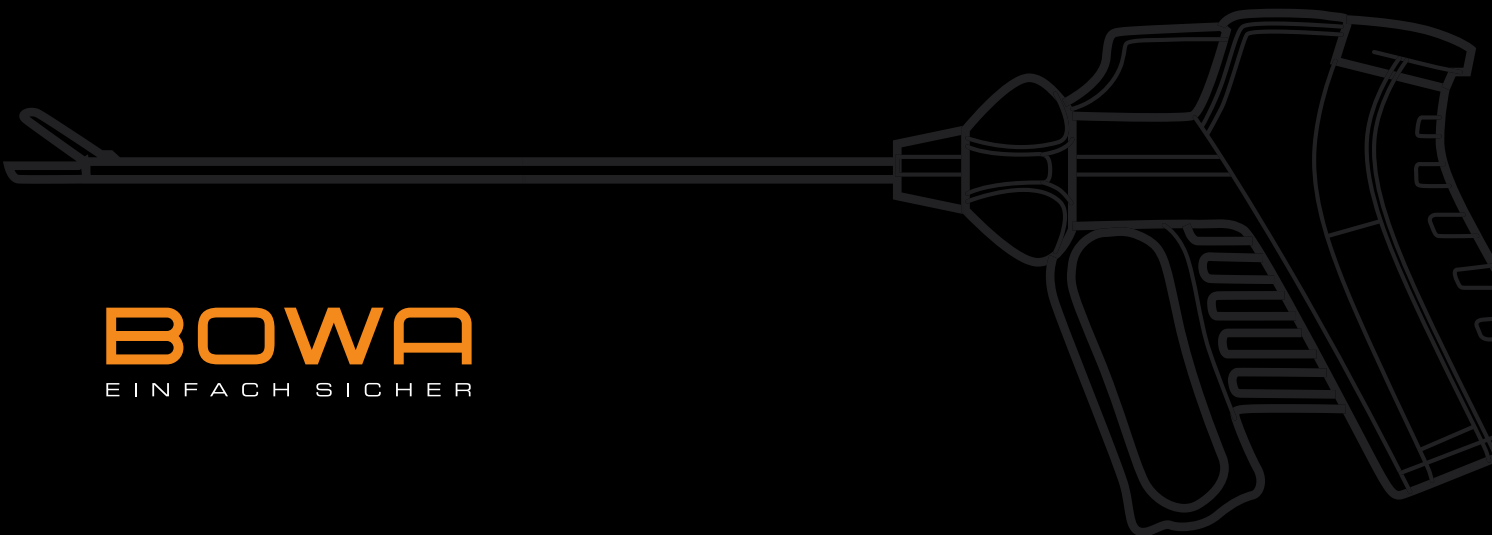

BOWA
EINFACH SICHER



Elektrochirurgie made by BOWA – Einfach sicher

Electrosurgery made by BOWA – Simply safe

Électrochirurgie BOWA – Sûr, tout simplement

Electrocirugía made by BOWA – Sencillamente seguro

Elettrochirurgia made by BOWA – Semplicemente sicuri

„Einfach sicher“ ist mehr als nur ein Versprechen. Es ist für uns die Verpflichtung, stets über den momentanen Standard hinauszudenken. Diese Haltung führt uns zu Lösungen, die neue Perspektiven aufzeigen und Sie in Ihrer Arbeit bestmöglich unterstützen.

„Simply safe“ is more than just a promise. For us it is the commitment to always think past the current standards. This approach leads us to solutions that open up new perspectives and support you optimally in your work.

„Sûr, tout simplement“ est plus qu’une simple promesse. C’est notre engagement de toujours penser au-delà des normes existantes. Cette approche nous mène à des solutions ouvrant de nouvelles perspectives et optimisant votre travail.

„Sencillamente seguro“ es más que una mera promesa. Tenemos el compromiso de pensar siempre más allá del estándar del momento. Esta actitud nos lleva a soluciones que muestran nuevas perspectivas y que le ayudan en su trabajo de la mejor manera.

„Semplicemente sicuro“ è più che una promessa. Per noi è l’impegno di pensare sempre oltre gli standard attuali. Tale approccio ci porta a soluzioni che aprono nuove prospettive e che aiutano l’utente in modo ottimale nel suo lavoro.















Symbole

Symbols

Symboles

Símbolos

Simboli

 Allgemeinchirurgie General Surgery Chirurgie générale Cirugía general Chirurgia Generale	 Herzchirurgie Cardiac Surgery Chirurgie cardiaque Cirugía cardiovascular Cardiochirurgia	 Kinderchirurgie Pediatric Surgery Chirurgie pédiatrique Cirugía pediátrica Chirurgia Pediatrica	 Orthopädie und Unfallchirurgie Orthopedics and Traumatology Orthopédie et traumatologie Ortopedia y cirugía traumatológica Ortopedia e Chirurgia Traumatologica	 Plastische und Ästhetische Chirurgie Plastic and Aesthetic Surgery Chirurgie plastique et esthétique Cirugía estética y plástica Chirurgia Plastica ed Estetica
 Thoraxchirurgie Thoracic Surgery Chirurgie thoracique Cirugía torácica Chirurgia Toracica	 Viszeralchirurgie Visceral Surgery Chirurgie viscérale Cirugía visceral Chirurgia Digestiva	 Gynäkologie Gynaecology Gynécologie Ginecología Ginecologia	 HNO ENT ORL Otorrinolaringología ORL	 Neurochirurgie Neuro Surgery Neurochirurgie Neurocirugía Neurochirurgia
 Dermatologie Dermatology Dermatologie Dermatología Dermatologia	 Mund-Kiefer-Gesichtschirurgie Oral and maxillofacial Surgery Chirurgie maxillo-faciale Cirugía oral y maxilofacial Chirurgia Maxillo-Facciale	 Urologie Urology Urologie Urologia Urologia	 Gastroenterologie Gastroenterology Gastroentérologie Gastroenterología Gastroenterologia	 Pulmologie Pneumology Pneumologie Neumología Pneumologia

	<p>Handgriffe und Elektroden Handles and electrodes Manches et électrodes Lápices y electrodos Manipoli ed elettrodi</p>	6 – 29
	<p>Kabel, Adapter und Zubehör, Zubehörtester Cables, adaptors and accessories, Accessory tester Câble, adaptateurs et accessoires, testeur d'accessoires Cables, adaptadores y accesorios, comprobador de accesorios Cavi, adattatori ed accessori, apparecchio di collaudo per accessori</p>	30 – 43
	<p>Instrumente für Laparoskopie – MetraLOOP®, LapHaken, ErgoLAP, ERGO 300 Instruments for laparoscopy – MetraLOOP®, Lap. hook, ErgoLAP, ERGO 300 Instruments pour laparoscopie – MetraLOOP®, Crochet, ErgoLAP, ERGO 300 Instrumentos para laparoscopia – MetraLOOP®, Gancho lap, ErgoLAP, ERGO 300 Strumenti per laparoscopia – MetraLOOP®, elettrodi laparoscopici a uncino, ErgoLAP, ERGO 300</p>	44 – 71
	<p>Pinzetten Forceps Pincers Pinzas Pinze</p>	72 – 97
	<p>BiZZER® – Bipolare Schere BiZZER® – Bipolar scissors BiZZER® – Ciseaux bipolaires BiZZER® – Tijeras bipolares BiZZER® – Forbici bipolari</p>	98 – 103
	<p>LIGATION – Gefäßversiegelung LIGATION – Vessel sealing LIGATION – Scellement vasculaire LIGATION – Sellado de vasos LIGATION – Sintesi dei vasi</p>	104 – 123
	<p>Argon assistierte Elektrochirurgie Argon-assisted electrocautery Électrochirurgie assistée à l'argon Electrocauterio asistida con argón Elettrochirurgia coadiuvata ad argon</p>	124 – 133
	<p>Neutralelektroden Neutral electrodes Électrodes neutres Electrodos neutros Elettrodi neutri</p>	134 – 147
	<p>ARC System und Zubehörteile ARC system and accessories Systèmes ARC et accessoires Sistema ARC y accesorios Sistema ARC e accessori</p>	148 – 161
	<p>ARC CART – Gerätewagen und Anbauteile ARC CART – Equipment trolley and attachments ARC CART – Chariot et accessoires ARC CART – Carro de equipo y piezas de montaje ARC CART – Carrello e elementi collegabili</p>	162 – 173
	<p>SHE SHA Rauchgasabsaugung SHE SHA smoke evacuation Aspirateur de fumées SHE SHA Aspiración de humo SHE SHA SHE SHA aspiratore di fumi chirurgici</p>	174 – 179
	<p>Sets Sets Sets Sets Set</p>	180 – 203

COMFORT-SYSTEM

Weltweit die erste universelle und interdisziplinäre Instrumentenerkennung
 The first universal and interdisciplinary instrument detection system in the world
 Optimisation des processus pour tous les instruments et domaines d'application
 Optimización de procesos para todos los instrumentos y áreas de aplicación
 Ottimizzazione dei processi per tutti gli strumenti e i campi di impiego

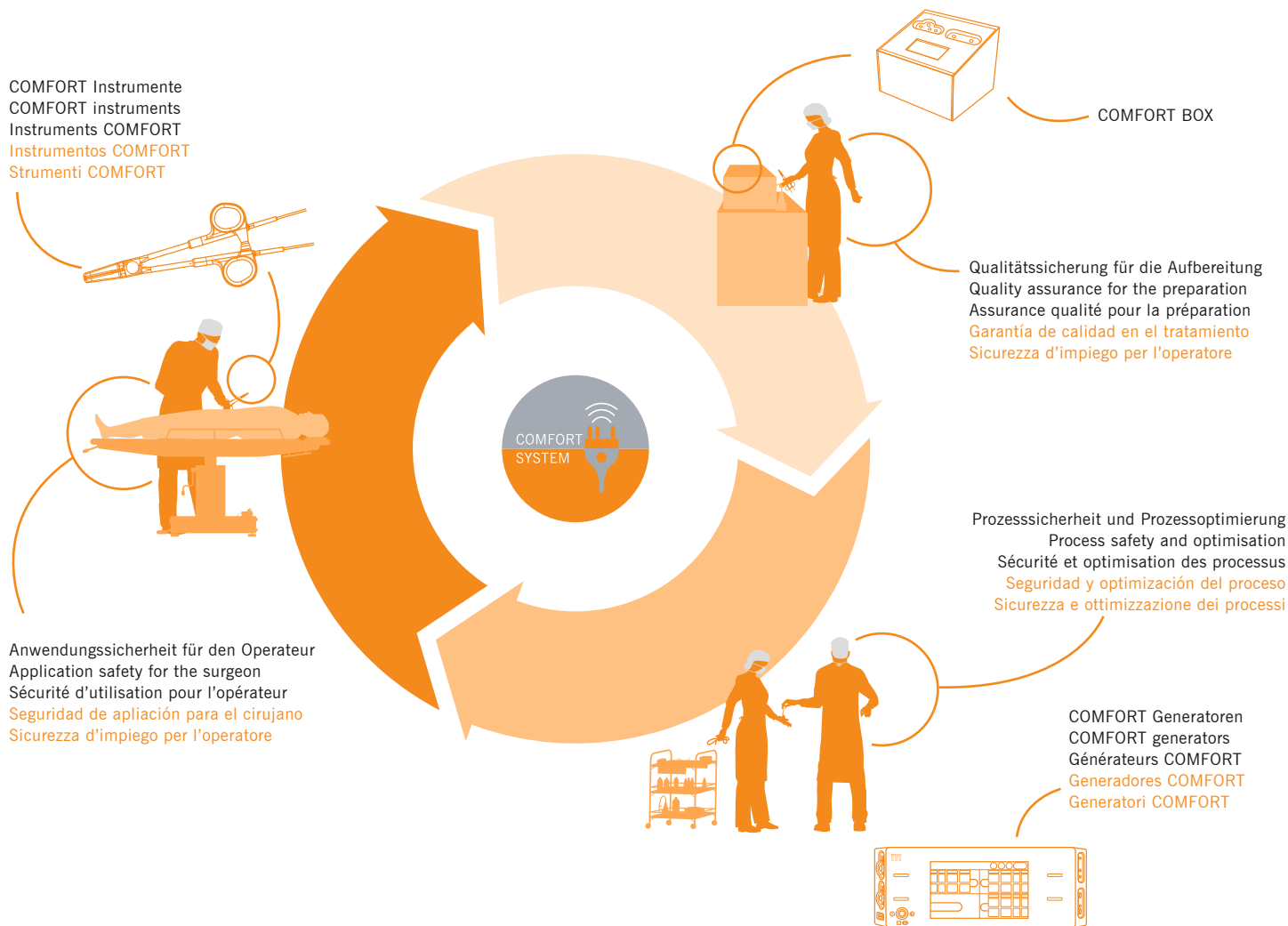

Nutzen Sie die COMFORT BOX zur Überprüfung der Aufbereitungszyklen intelligenter Instrumente
 Use the COMFORT BOX for checking the preparation cycles of intelligent instruments.
 Utilisez le BOÎTIER COMFORT pour vérifier les cycles de préparation des instruments intelligents
 Utilice la COMFORT BOX para verificar los ciclos de preparación de instrumentos inteligentes
 Utilizzi la COMFORT BOX per verificare i cicli di preparazione di strumenti intelligenti

	1 x COMFORT BOX 5 x REF 215-145 (4 mm) 5 x REF 101-140	050-240
	1 x COMFORT BOX 5 x REF 218-145 (2.4 mm) 5 x REF 101-140	050-241
	COMFORT BOX	050-242

BIZZER®



100-103

LIGATION – ERGO 310D



110-113

EASY



136-143

1 Handgriffe und Elektroden
 Handles and electrodes
 Manches et électrodes
 Lápices y electrodos
 Manipoli ed elettrodi

<p>1.1 Elektrodenhandgriffe 1.1.1 Elektrodenhandgriffe 1.1.2 Einmal-Handgriffe 1.1.3 Adapter monopolar 1.2 Elektroden 1.2.1 Elektroden 1.2.2 Elektrodenverlängerungen 1.2.3 Elektrodenbehälter 1.2.4 Elektroden mit isoliertem Schaft 1.3 Einmal-Elektroden 1.3.1 NON-Stick Einmal-Elektroden 1.3.2 Einmal-Elektroden 1.3.3 Zubehör 1.4 Arthroskopie-Elektroden</p>	<p>1.1 Electrode handles 1.1.1 Electrode handles 1.1.2 Disposable pencils 1.1.3 Adaptors monopolar 1.2 Electrodes 1.2.1 Electrodes 1.2.2 Electrode extensions 1.2.3 Electrode container 1.2.4 Electrodes with insulated shaft 1.3 Disposable electrodes 1.3.1 NON-Stick Disposable electrodes 1.3.2 Disposable electrodes 1.3.3 Accessories 1.4 Arthroscopic electrodes</p>	<p>1.1 Manches de bistouri 1.1.1 Manches de bistouri 1.1.2 Manches à usage unique 1.1.3 Adaptateurs monopolaires 1.2 Electrodes 1.2.1 Electrodes 1.2.2 Prolongateurs d'électrodes 1.2.3 Récipient d'électrodes 1.2.4 Electrodes à tiges isolées 1.3 Electrodes à usage unique 1.3.1 NON-Stick Electrodes à usage unique 1.3.2 Electrodes à usage unique 1.3.3 Accessoires 1.4 Electrodes arthroscopiques</p>
<p>1.1 Mangos porta electrodos 1.1.1 Mangos porta electrodos 1.1.2 Mangos porta electrodos desechables 1.1.3 Adaptadores monopolares 1.2 Electrodos 1.2.1 Electrodos 1.2.2 Alargamiento para electrodos 1.2.3 Recipiente para electrodos 1.2.4 Electrodos con asta aislada 1.3 Electrodos desechables 1.3.1 NON-Stick Electrodos desechables 1.3.2 Electrodos desechables 1.3.3 Accesorios 1.4 Electrodos de artroscopia</p>	<p>1.1 Manipoli per elettrodi 1.1.1 Manipoli per elettrodi 1.1.2 Manipoli monouso 1.1.3 Adattatori monopolari 1.2 Elettrodi 1.2.1 Elettrodi 1.2.2 Prolunghe per elettrodi 1.2.3 Contenitore per elettrodi 1.2.4 Elettrodi con asta isolata 1.3 Elettrodi monouso 1.3.1 NON-Stick Elettrodi monouso 1.3.2 Elettrodi monouso 1.3.3 Accessori 1.4 Elettrodi per artroscopia</p>	

<p>Alle wiederverwendbaren Instrumente werden im unsterilen Zustand angeliefert und können bei 134 °C / 20 min sterilisiert werden. Alle Einmalprodukte sind nicht für den mehrmaligen Gebrauch vorgesehen. Für die allgemeine Wischdesinfektion können handelsübliche Mittel verwendet werden. Für unsachgemäße Reinigung, Sterilisation und Anwendung kann seitens BOWA keine Haftung übernommen werden. Die Produkte tragen das CE Zeichen nach Richtlinie 93 / 42 / EWG</p>	<p>All reusable instruments are supplied in an unsterile state and can be sterilised at 134 °C for 20 min. All single-use products are not intended for multiple usage. Commercially available agents can be used for general wiping and disinfection. BOWA can accept no liability for improper cleaning, sterilisation and use. The products are certified according to 93 / 42 / EEC</p>	<p>Tous les instruments réutilisables sont livrés non stériles et peuvent être stérilisés à 134 °C / 20 min. Aucun produit à usage unique n'est destiné à être réutilisé. Des produits courants disponibles dans le commerce peuvent être utilisés pour un lavage désinfectant général. BOWA exclue toute responsabilité quant au nettoyage, à la stérilisation ou à l'utilisation non conformes ou inappropriés. Les produits sont certifiés selon la directive 93 / 42 / CEE</p>
---	---	--



Todos los instrumentos reutilizables se suministran en estado no estéril y deben ser esterilizados a 134 °C / 20 min.

Todos los productos desechables no son previstos para reutilización.

Para la desinfección superficial general pueden utilizarse productos comerciales corrientes.

BOWA no asume ningún tipo de responsabilidad por la limpieza, la esterilización y la utilización indebida.

Los productos están certificados según la norma 93 / 42 / CEE

Tutti gli strumenti riutilizzabili sono forniti non sterili e possono essere sterilizzati per 20 min a 134 °C.

Tutti i prodotti monouso sono destinati a non essere riutilizzati.

Per la pulizia e la disinfezione generale è possibile utilizzare i prodotti in commercio.

BOWA non si assume alcuna responsabilità per la pulizia, la sterilizzazione e l'uso non conforme.

I prodotti sono certificati in accordo con 93 / 42 / CEE

1.1 Elektrodenhandgriffe
Electrode handles
Manches de bistouri
Mangos porta electrodos
Manipoli per elettrodi

Für SHE SHA Rauchgasabsaugung
For SHE SHA Smoke Evacuation System
Pour SHE SHA Aspirateur de fumées
Para SHE SHA Aspirador de humos quirúrgicos
Per SHE SHA Aspiratore di fumi chirurgici



2.4 / 4 mm



Spannungssicherheit bis 6000 Vp
Voltage safety up to 6000 Vp
Sécurité de tension jusqu'à 6000 Vp
Seguridad de tensión hasta 6000 Vp
Sicurezza da tensioni fino a 6000 Vp

Sichere Identifikation und Nachverfolgung
Safe identification and tracking
Identification sûre et suivie
Identificación segura y rastreo
Identificazione e tracciabilità sicure

Blinde Orientierung dank Mittelsteg
Intuitive orientation due to the raised centre
Orientation aveugle grâce à un barre centrale
Orientación a ciegas por el puente central
Orientamento in cieco grazie alla barra centrale

6-Kant-Codierung
Hexagon coding
Codage hexagonal
Codificación hexagonal
Codificazione esagonale



Knickschutz
Bend protection
Manchon de protection
Protección contra doblezes
Protezione antipiego

Einwandfreie Hygiene
Perfect hygiene
Hygiène impeccable
Higiene impecable
Igiene perfetta

Kabel mit orangefarbenem
Sicherheitsstreifen
Cable with orange safety stripe
Câble avec liseré orange de sécurité
Cavo con raya de seguridad en naranja
Cavo con strisce di sicurezza arancioni

Extreme Langlebigkeit
Highly durable
Durabilité extraordinaire
Alta durabilidad
Estrema durata

! Hochwertige Haptik
High quality haptics
Haptique de haute qualité
Háptica de alta calidad
Elevata morbidezza al tatto



Empfohlene Modi bei BOWA ARC 400
Recommended modes for the BOWA ARC 400
Modes recommandés pour l'ARC 400 de BOWA
Modos recomendados con BOWA ARC 400
Modalità consigliate per BOWA ARC 400



Spray



CUT



COAG

1.1.1 Elektrodenhandgriffe
 Electrode handles
 Manches de bistouri
 Mangos porta electrodos
 Manipoli per elettrodi



6000 V_p



gold product design award



reddot winner



good design award



2.4 mm

4 mm



BOWA
 Erbe International
 Martin International
 Valleylab
 Conmed

327-045
 (4.5 m)

322-045
 (4.5 m)

COMFORT



-

-



Ø 8 mm

BOWA
 Erbe International
 Martin International
 Valleylab
 Conmed

-

-



Ø 5 mm

Erbe VIO / ICC / ACC

-

110-045
 (4.5 m)



Ø 4 mm

Erbe T-Serie

-

112-045
 (4.5 m)



12.5 mm
 8 mm
 4 mm

Martin

-

227-045
 (4.5 m)

ErgoPEN		JackKNIFE®			
 <p>145 mm</p>		 <p>155 mm</p>		 <p>140 mm</p>	
2.4 mm	4 mm	2.4 mm	4 mm	2.4 mm	4 mm
218-045 (4.5 m)	215-045 (4.5 m)	220-045 (4.5 m)	220-145 (4.5 m)	-	-
218-145 (4.5 m)	215-145 (4.5 m)	-	-	-	-
-	-	-	-	335-030 (4.5 m)	330-030 (4.5 m)
105-045 (4.5 m)	104-045 (4.5 m)	120-045 (4.5 m)	120-145 (4.5 m)	-	-
-	-	-	-	-	100-016 (4.5 m)
-	214-045 (4.5 m)	-	220-245 (4.5 m)	219-030 (4.5 m)	210-030 (4.5 m)

1.1.2 Einmal-Handgriffe
 Disposable pencils
 Manches à usage unique
 Mangos porta electrodos desechables
 Manipoli monouso



<div style="border: 1px solid orange; padding: 2px; display: inline-block;">6000V_p</div>				
Elektrodenhandgriff mit Wippschalter, 3 m Kabel und Standard-Messerelektrode 50 Stk. / Karton Steril verpackt	Electrode handle with "rocker switch", 3 m cable and standard blade electrode 50 pcs. / carton Sterile packing	Manche de bistouri à bascule, câble 3 m et électrode couteau standard 50 pcs. / carton Emballage stérile	Mango porta electrodos con pulsador tipo báscula, cable 3 m y electrodo cuchillo estándar 50 uds. / caja Embalaje estéril	Manipolo per elettrodi con pulsante oscillante cavo 3 m ed elettrodo standard a lama 50 pz. / cartone Imballaggio sterile
801-030 (3 m)		BOWA Erbe International Martin International Valleylab Conmed		

<div style="border: 1px solid orange; padding: 2px; display: inline-block;">6000V_p</div>				
Elektrodenhandgriff mit 2 Tasten, 3 m Kabel und Standard-Messerelektrode 50 Stk. / Karton Steril verpackt	Electrode handle with 2 "click buttons", 3 m cable and standard blade electrode 50 pcs. / carton Sterile packing	Manche de bistouri avec deux boutons, câble 3 m et électrode couteau standard 50 pcs. / carton Emballage stérile	Mango porta electrodos con dos pulsadores digitales, cable 3 m y electrodo cuchillo estándar 50 uds. / caja Embalaje estéril	Manipolo per elettrodi con due tasti, cavo 3 m ed elettrodo standard a lama 50 pz. / cartone Imballaggio sterile
802-030 (3 m)		BOWA Erbe International Martin International Valleylab Conmed		

<div style="border: 1px solid orange; padding: 2px; display: inline-block;">5000V_p</div>				
Elektrodenhandgriff mit 2 Tasten, 5 m Kabel und Standard-Messerelektrode, Ø 2,4 mm 50 Stk. / Karton Steril verpackt	Electrode handle with 2 "click buttons", 5 m cable and standard blade electrode, Ø 2,4 mm 50 pcs. / carton Sterile packing	Manche de bistouri avec deux boutons, câble 5 m et électrode couteau standard, Ø 2,4 mm 50 pcs. / carton Emballage stérile	Mango porta electrodos con dos pulsadores digitales, cable 5 m y electrodo cuchillo estándar, Ø 2,4 mm 50 uds. / caja Embalaje estéril	Manipolo per elettrodi con due tasti, cavo 5 m ed elettrodo standard a lama, Ø 2,4 mm 50 pz. / cartone Imballaggio sterile
802-035 (5 m)		BOWA / Valleylab 3-Pin		



	<p>SHE SHA Handgriff, l�nglenverstellbar, 2 Tasten, Messer, 3 m, Einweg, steril (10 Stk.) inkl. Holster SHE SHA handle, adjustable length, 2 buttons, knife electrode, 3 m, single-use, sterile (10 pcs.) incl. holster Manche SHE SHA, r�glable en longueur, 2 boutons, couteau, 3 m, usage unique, st�rile (10 unit�s), �tui incl. L�piz SHE SHA, ajustable en longitud, 2 botones, cuchilla, 3 m, desechable, esterilizado (10 uds.) incl. funda Manipolo SHE SHA, regolabile in lunghezza, 2 tasti, bisturi, 3 m, monouso, sterile (10 pz.) incl. custodia</p>	
	<p>802-033 (3 m)</p>	<p>BOWA Erbe International Martin International Valleylab Conmed</p>
	<p>SHE SHA Handgriff, 2 Tasten, Messer, 3 m, Einweg, steril (10 Stk.) inkl. Holster SHE SHA handle, 2 buttons, knife electrode, 3 m, single-use, sterile (10 pcs.) incl. holster Manche SHE SHA, 2 boutons, couteau, 3 m, usage unique, st�rile (10 unit�s), �tui incl. L�piz SHE SHA, 2 botones, cuchilla, 3 m, desechable, esterilizado (10 uds.) incl. funda Manipolo SHE SHA, 2 tasti, bisturi, 3 m, monouso, sterile (10 pz.) incl. custodia</p>	
	<p>802-032 (3 m)</p>	<p>BOWA Erbe International Martin International Valleylab Conmed</p>

1.2.1 Elektroden
Electrodes
Electrodes
Electrodos
Elettrodi

134°C
Autoclave
273°F

6000V_p

4 / 2.4 mm

6-Kant-Codierung
Hexagon coding
Codage hexagonal
Codificación hexagonal
Codificazione esagonale



Messer, Kugel, Nadel, Drahtschlinge
Blade, ball, needle, wire loop
Couteau, boule, aiguille, anse a fil
Cuchillo, bola, aguja, asa de alambre
Lama, sfera, ago, ansa di filo metallico

Hitzebeständige Sicherheits-Isolation
Heat-resistant safety insulation
Isolant de sécurité résistant à la chaleur
Aislamiento de seguridad, resistente al calor
Isolazione di sicurezza termoresistente

Scharfe Wolfram Mikro-Elektrode
Sharp tungsten micro electrode
Micro-électrode aiguisée en tungstène
Microelectrodo agudo de tungsteno
Microlettrodo di tungsteno

Minimale Wärmeausbreitung
Minimal thermal spread
Dispersion thermique minimale
Propagación térmica mínima
Minima diffusione termica

Empfohlene Modi bei BOWA ARC 400
Recommended modes for the BOWA ARC 400
Modes recommandés pour l'ARC 400 de BOWA
Modos recomendados con BOWA ARC 400
Modalità consigliate per BOWA ARC 400

-  Spray
-  CUT
-  COAG

Verschiedene Ausführungen
Various designs
Plusieurs modèles
Varios tipos
Vari tipi







6000V _P		 Ø 4 mm	 BOWA Ø 2.4 mm reusable	
		500-007	530-207	Messer / 5 Stk. Blade / 5 pcs. Couteau / 5 pcs. Cuchillo / 5 uds. Lama / 5 pz.
1:1				
		500-127	530-127	Messer, fein / 5 Stk. Blade, thin / 5 pcs. Couteau, fin / 5 pcs. Cuchillo, fino / 5 uds. Lama, sottile / 5 pz.
1:1				
	◇	500-009	530-009	Messer rautenförmig / 5 Stk. Knife, rhombic / 5 pcs. Couteau, rhombique / 5 pcs. Cuchillo, rómbico / 5 uds. Lama, romboidale / 5 pz.
1:1				
	◇	500-008	530-008	Messer, rautenförmig, abgewinkelt / 5 Stk. Knife, rhombic, angled / 5 pcs. Couteau, rhombique, coudée / 5 pcs. Cuchillo, rómbico, acodado / 5 uds. Lama romboidale angolata / 5 pz.
1:1				
	●	500-126	530-126	Spatel / 5 Stk. Lancet / 5 pcs. Spatule / 5 pcs. Espátula / 5 uds. Spatola / 5 pz.
1:1				
	●	500-125	530-125	Spatel, abgewinkelt / 5 Stk. Lancet, angled / 5 pcs. Spatule, coudée / 5 pcs. Espátula, acodada / 5 uds. Spatola angolata / 5 pz.
1:1				





1.2.1 Elektroden
Electrodes
Electrodes
Electrodos
Elettrodi

134°C
Autoclave
273°F



<div style="border: 1px solid black; padding: 5px; display: inline-block;">6000 V_p</div>	 Ø 4 mm	 BOWA Ø 2.4 mm reusable	
 1:1	500-011	530-211	Nadel / 5 Stk. Needle / 5 pcs. Aiguille / 5 pcs. Aguja / 5 uds. Ago / 5 pz.
 1:1	500-124	530-124	Nadel, abgewinkelt / 5 Stk. Needle, angled / 5 pcs. Aiguille, coudée / 5 pcs. Aguja, acodada / 5 uds. Ago, angolato / 5 pz.



<div style="border: 1px solid black; padding: 5px; display: inline-block;">800 V_p</div>	 Ø 4 mm	 BOWA Ø 2.4 mm reusable	
 1:1	500-112	530-012	Isolierte Mikro-Nadelelektrode, Wolframdraht / 1 Stk. Insulated micro needle electrode, tungsten wire / 1 pcs. Micro-électrode aiguille, isolée avec filament en tungstène / 1 pcs. Micro-electrodo de aguja, alambre de tungsteno / 1 uds. Microelettrodo di tungsteno, isolato, ad ago / 1 pz.
 1:1	500-113	530-013	Wie oben / 1 Stk. See above / 1 pcs. Voir plus haut / 1 pcs. Véase arriba / 1 uds. Come sopra indicato / 1 pz.













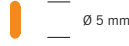



6000V _p				
 ● — Ø 1.5 mm	500-019	-		Kugel / 5 Stk. Ball / 5 pcs. Boule / 5 pcs. Bola / 5 uds. Sfera / 5 pz.
 ● — Ø 1.5 mm	500-129	-		Kugel, abgewinkelt / 5 Stk. Ball, angled / 5 pcs. Boule, coudée / 5 pcs. Bola, acodada / 5 uds. Sfera, angolata / 5 pz.
 ● — Ø 2 mm	500-020	530-020		Kugel / 5 Stk. Ball / 5 pcs. Boule / 5 pcs. Bola / 5 uds. Sfera / 5 pz.
 ● — Ø 2 mm	500-130	530-130		Kugel, abgewinkelt / 5 Stk. Ball, angled / 5 pcs. Boule, coudée / 5 pcs. Bola, acodada / 5 uds. Sfera, angolata / 5 pz.
 ● — Ø 4 mm	500-021	530-021		Kugel / 5 Stk. Ball / 5 pcs. Boule / 5 pcs. Bola / 5 uds. Sfera / 5 pz.
 ● — Ø 4 mm	500-131	-		Kugel, abgewinkelt / 5 Stk. Ball, angled / 5 pcs. Boule, coudée / 5 pcs. Bola, acodada / 5 uds. Sfera, angolata / 5 pz.
 ● — Ø 6 mm	500-022	530-022		Kugel / 5 Stk. Ball / 5 pcs. Boule / 5 pcs. Bola / 5 uds. Sfera / 5 pz.

1.2.1 Elektroden
Electrodes
Electrodes
Electrodos
Elettrodi

134°C
Autoclave
273°F

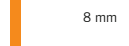

6000V _p		 Ø 4 mm	 BOWA Ø 2.4 mm reusable	
 1:1	 Ø 5 mm	500-014	530-014	Drahtschlinge / 5 Stk. Wire loop / 5 pcs. Anse à fil / 5 pcs. Asa de alambre / 5 uds. Ansa di filo metallico / 5 pz.
 1:1	 Ø 10 mm	500-015	530-015	Drahtschlinge / 5 Stk. Wire loop / 5 pcs. Anse à fil / 5 pcs. Asa de alambre / 5 uds. Ansa di filo metallico / 5 pz.
 1:1	 Ø 14 mm	500-016	530-016	Drahtschlinge / 5 Stk. Wire loop / 5 pcs. Anse à fil / 5 pcs. Asa de alambre / 5 uds. Ansa di filo metallico / 5 pz.
 1:1	 Ø 10 mm	500-017	530-017	Bandschlinge / 5 Stk. Ribbon loop / 5 pcs. Anse à bande / 5 pcs. Asa de cinta / 5 uds. Ansa a nastro / 5 pz.
 1:1	 Ø 17 mm	500-018	-	Bandschlinge / 5 Stk. Ribbon loop / 5 pcs. Anse à bande / 5 pcs. Asa de cinta / 5 uds. Ansa a nastro / 5 pz.
 1:1	 8 mm	500-023	-	Flächenelektrode, 8 x 10 mm / 1 Stk. Plate electrode, 8 x 10 mm / 1 pcs. Electrode palette, 8 x 10 mm / 1 pcs. Electrodo de placa, 8 x 10 mm / 1 uds. Elettrodo a piastra, 8 x 10 mm / 1 pz.
 1:1	 10 mm	500-024	-	Flächenelektrode, 10 x 15 mm / 1 Stk. Plate electrode, 10 x 15 mm / 1 pcs. Electrode palette, 10 x 15 mm / 1 pcs. Electrodo de placa, 10 x 15 mm / 1 uds. Elettrodo a piastra, 10 x 15 mm / 1 pz.

1.2.2 Elektrodenverlängerungen
 Electrode extensions
 Prolongateurs d'électrodes
 Alargamiento para electrodos
 Prolunghe per elettrodi

134°C
 Autoclave
 273°F

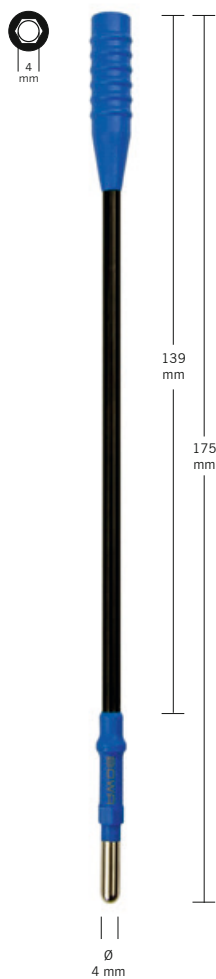

500-150

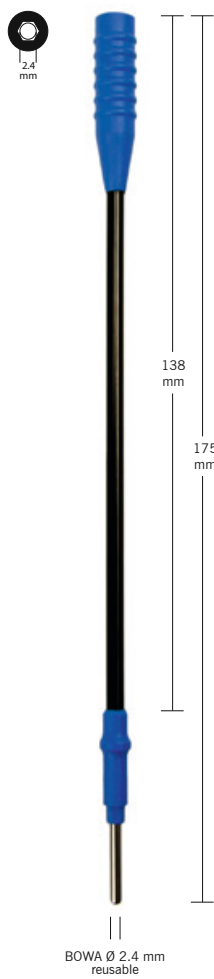

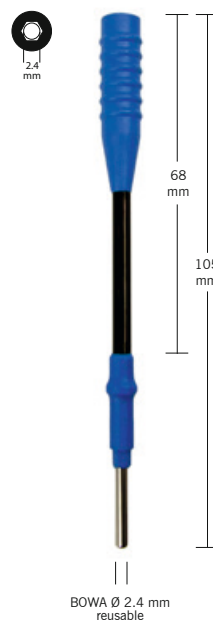

530-150



530-070

1.2.3 Elektrodenbehälter
 Electrode container
 Récipient d'électrodes
 Recipiente para electrodos
 Contenitore per elettrodi













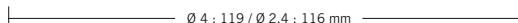
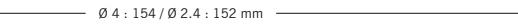

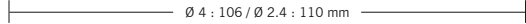
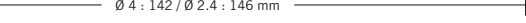
<p>* 1 Stk. 1 pc. 1 pc. 1 pz. 1 pezzo</p>  <p>Ø 4 mm</p>	<p>500-000</p>	500-007*
		500-009*
		500-008*
		500-126*
		500-011*
		500-022*
		500-021*
		500-015*
		500-014*
		500-018*
		500-017*
		500-023*
	<p>Elektrodenbehälter komplett mit Einsatz, Deckel und 12 Standardelektroden, Schaft 4 mm Ø Electrode container with lid, rack and 12 standard electrodes, shaft 4 mm Ø Récipient d'électrodes, avec support, couvercle et 12 électrodes standard, tige 4 mm Ø Recipiente completo con soporte, tapa y 12 electrodos estándar, asta 4 mm Ø Contenitore con supporto, coperchio e 12 elettrodi standard, stelo 4 mm Ø</p>	
<p>* 1 Stk. 1 pc. 1 pc. 1 pz. 1 pezzo</p>  <p>Ø 2.4 mm</p>	<p>530-000</p>	530-207*
		530-009*
		530-008*
		530-126*
		530-125*
		530-211*
		530-124*
		530-022*
		530-021*
		530-020*
		530-015*
		530-017*
	<p>Elektrodenbehälter komplett mit Einsatz, Deckel und 12 Standardelektroden, Schaft 2.4 mm Ø Electrode container with lid, rack and 12 standard electrodes, shaft 2.4 mm Ø Récipient d'électrodes, avec support, couvercle et 12 électrodes standard, tige 2.4 mm Ø Recipiente completo con soporte, tapa y 12 electrodos estándar, asta 2.4 mm Ø Contenitore con supporto, coperchio e 12 elettrodi standard, stelo 2.4 mm Ø</p>	

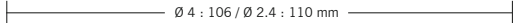
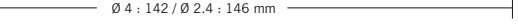
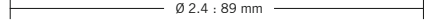
1.2.4 Elektroden mit isoliertem Schaft
 Electrodes with insulated shaft
 Electrodes à tiges isolées
 Electrodoos con asta aislada
 Elettrodi con asta isolata

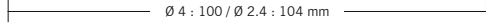
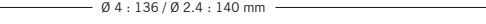
134°C
 Autoclave
 273°F

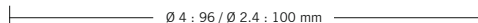



	 Ø 4 mm	 BOWA Ø 2.4 mm reusable	
  	520-028	530-028	Messer Knife Couteau Cuchillo Lama
  	520-124	530-224	Messer, rautenförmig Knife, rhombic Couteau, rhombique Cuchillo, rómbico Lama, romboidale
  	520-123	530-123	Messer, rautenförmig Knife, rhombic Couteau, rhombique, coudé Cuchillo, rómbico Lama, romboidale
  	-	530-225	Für HNO For otolaryngology Pour ORL Para la otorrinolaringología Per ORL
  	520-027	530-027	Nadel Needle Aiguille Aguja Ago
  	520-122	530-122	Nadel, abgewinkelt Needle, angled Aiguille, coudée Aguja, acodada Ago, angolato





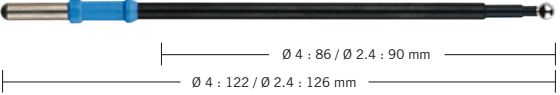
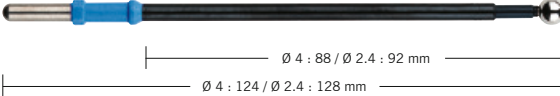
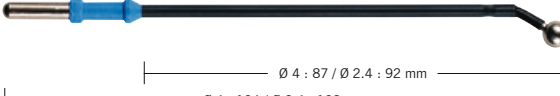
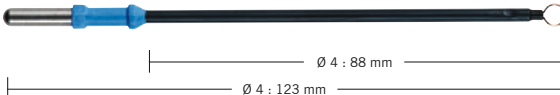
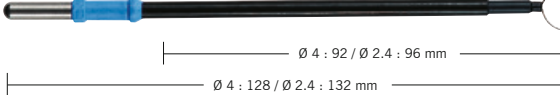

1.2.4 Elektroden mit isoliertem Schaft
 Electrodes with insulated shaft
 Electrodes à tiges isolées
 Electrodoos con asta aislada
 Elettrodi con asta isolata

134°C
 Autoclave
 273°F

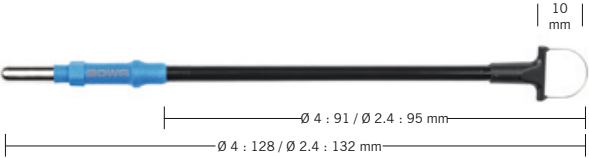

	 Ø 4 mm	 BOWA Ø 2.4 mm reusable	
 <p>Ø 4 : 86 / Ø 2.4 : 90 mm Ø 4 : 122 / Ø 2.4 : 126 mm</p> <p>● — Ø 4 mm</p>	520-029	530-029	Kugel, Ø 4 mm Ball, Ø 4 mm Boule, Ø 4 mm Bola, Ø 4 mm Sfera, Ø 4 mm
 <p>Ø 4 : 88 / Ø 2.4 : 92 mm Ø 4 : 124 / Ø 2.4 : 128 mm</p> <p>● — Ø 6 mm</p>	520-030	530-030	Kugel, Ø 6 mm Ball, Ø 6 mm Boule, Ø 6 mm Bola, Ø 6 mm Sfera, Ø 6 mm
 <p>Ø 4 : 87 / Ø 2.4 : 92 mm Ø 4 : 124 / Ø 2.4 : 128 mm</p> <p>● — Ø 6 mm</p>	520-035	530-035	Kugel, abgewinkelt, Ø 6 mm Ball, angled, Ø 6 mm Boule, coudée, Ø 6 mm Bola, acodada, Ø 6 mm Sfera, curva, Ø 6 mm
 <p>Ø 4 : 88 mm Ø 4 : 123 mm</p> <p>— — Ø 5 mm</p>	520-031	-	Drahtschlinge, 0.35 mm Wire loop, 0.35 mm Anse à fil, 0.35 mm Asa de alambre, 0.35 mm Ansa, 0.35 mm
 <p>Ø 4 : 92 / Ø 2.4 : 96 mm Ø 4 : 128 / Ø 2.4 : 132 mm</p> <p>— — Ø 10 mm</p>	520-032	530-032	Drahtschlinge, 0.35 mm Wire loop, 0.35 mm Anse à fil, 0.35 mm Asa de alambre, 0.35 mm Ansa, 0.35 mm



<div style="border: 1px solid orange; padding: 5px; display: inline-block;">3200 V_P</div>	 Ø 4 mm	 BOWA Ø 2.4 mm reusable	
	520-134	530-134	
	520-135	530-135	
	520-133	530-133	Schlinge, 0.4 mm Loop, 0.4 mm Anse, 0.4 mm Asa, 0.4 mm Ansa, 0.4 mm
	520-132	530-132	
	520-136	530-136	

1.3.1 NON-Stick Einmal-Elektroden
 NON-Stick Disposable electrodes
 NON-Stick Electrodes à usage unique
 NON-Stick Electrodo desechables
 NON-Stick Elettrodi monouso



Saubere Elektroden – Sauberer Schnitt – Zeitsparend
 Clean electrodes – Clean cut – Time-saving
 Electrodes propres – Coupe propre – Gain de temps
 Electrodo limpio – Corte limpio – Ahorro de tiempo
 Elettrodi puliti – Taglio pulito – Risparmio di tempo

6000V_P

Biegsam und belastbar
 Flexible and resilient
 Flexible et résistant
 Flexible y resistente
 Pieghevole e resistente

Schneiden oder Dissektion
 Cutting or dissection
 Section ou dissection
 Corte o disección
 Taglio o dissezione

Einfache Reinigung
 Easy to clean
 Facile à nettoyer
 Fácil de limpiar
 Facile da pulire

Gewebeunabhängig
 Independent of tissue
 Indépendant du tissu
 Independiente del tejido
 Indipendente dal tessuto

Antihftbeschichtung
 Non-stick coating
 Traitement anti-adhésif
 Revestimiento antiadherente
 Rivestimento antiadesivo

Verschiedene Ausführungen
 Various designs
 Plusieurs modèles
 Varios tipos
 Vari tipi

2.4 mm

Empfohlene Modi bei BOWA ARC 400
 Recommended modes for the BOWA ARC 400
 Modes recommandés pour l'ARC 400 de BOWA
 Modos recomendados con BOWA ARC 400
 Modalità consigliate per BOWA ARC 400



Spray







CUT

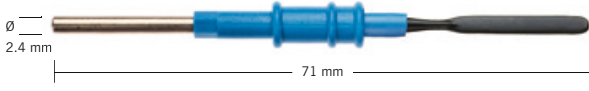
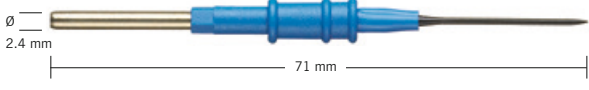
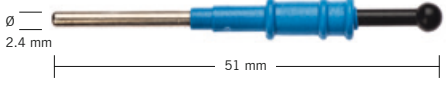

COAG

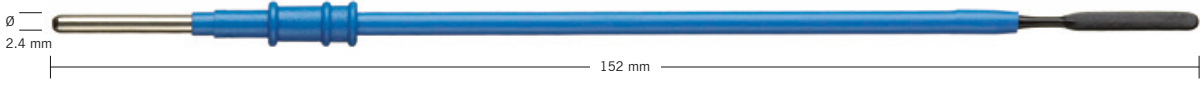
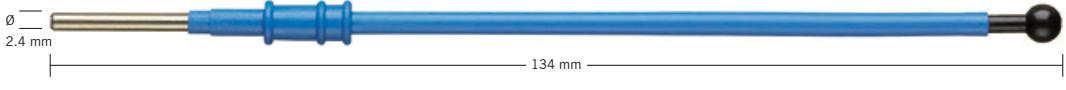

 <p>∅ 2.4 mm 71 mm</p> <p>1:1</p>	
800-001	
<p>NON-Stick Messerelektrode, steril verpackt / 10 Stk. NON-Stick Blade electrode, sterile packing / 10 pcs. NON-Stick Electrode couteau, emballage stérile / 10 pcs. NON-Stick Electrodo cuchillo, embalaje estéril / 10 uds. NON-Stick Elettrodo a lama, imballaggio sterile / 10 pz.</p>	
 <p>∅ 2.4 mm 71 mm</p> <p>1:1</p>	
800-002	
<p>NON-Stick Nadelelektrode, steril verpackt / 10 Stk. NON-Stick Needle electrode, sterile packing / 10 pcs. NON-Stick Electrode aiguille, emballage stérile / 10 pcs. NON-Stick Electrodo aguja, embalaje estéril / 10 uds. NON-Stick Elettrodo ad ago, imballaggio sterile / 10 pz.</p>	
 <p>∅ 2.4 mm 51 mm</p> <p>1:1</p>	 ∅ 4 mm
800-003	
<p>NON-Stick Kugelelektrode, Ø 4 mm, steril verpackt / 10 Stk. NON-Stick Ball electrode, Ø 4 mm, sterile packing / 10 pcs. NON-Stick Electrode boule, Ø 4 mm, emballage stérile / 10 pcs. NON-Stick Electrodo bola, Ø 4 mm, embalaje estéril / 10 uds. NON-Stick Elettrodo a sfera, Ø 4 mm, imballaggio sterile / 10 pz.</p>	
 <p>∅ 2.4 mm 152 mm</p> <p>1:1</p>	
800-004	
<p>NON-Stick Messerelektrode, lang, steril verpackt / 10 Stk. NON-Stick Extended blade electrode, sterile packing / 10 pcs. NON-Stick Electrode longue, couteau, emballage stérile / 10 pcs. NON-Stick Electrodo cuchillo, largo, embalaje estéril / 10 uds. NON-Stick Elettrodo a lama, lungo, imballaggio sterile / 10 pz.</p>	
 <p>∅ 2.4 mm 134 mm</p> <p>1:1</p>	 ∅ 5 mm
800-005	
<p>NON-Stick Kugelelektrode, lang, Ø 5 mm, steril verpackt / 10 Stk. NON-Stick Extended ball electrode, Ø 5 mm, sterile packing / 10 pcs. NON-Stick Electrode, longue, boule, Ø 5 mm, emballage stérile / 10 pcs. NON-Stick Electrodo bola, largo, Ø 5 mm, embalaje estéril / 10 uds. NON-Stick Elettrodo a sfera, lungo, Ø 5 mm, imballaggio sterile / 10 pz.</p>	

1.3.2 Einmal-Elektroden
 Disposable electrodes
 Electrodes à usage unique
 Electrodo desechables
 Elettrodi monouso



<p>Ø 2.4 mm 69 mm 19 mm 1:1</p>	
800-007	
<p>Messerelektrode, Schaft 2,4 mm, Einweg, steril (5 Stk.) Knife electrode, shaft 2.4 mm, single-use, sterile (5 pcs.) Électrode couteau, tige 2,4 mm, usage unique, stérile (5 pcs.) Electrodo cuchillo, diam. 2,4 mm, desechable, estéril (5 uds.) Elettrodo a lama, stelo 2,4 mm, monouso, sterile (5 pz.)</p>	
<p>Ø 2.4 mm 69 mm 19 mm x 0.8 mm 1:1</p>	•
800-011	
<p>Nadelelektrode, Schaft 2,4 mm, Einweg, steril (5 Stk.) Needle electrode, shaft 2.4 mm, single-use, sterile (5 pcs.) Électrode aiguille, tige 2,4 mm, usage unique, stérile (5 pcs.) Electrodo tipo aguja, diam. 2,4 mm, desechable, estéril (5 uds.) Elettrodo ad ago, stelo 2,4 mm, monouso, sterile (5 pz.)</p>	
<p>Ø 2.4 mm 69 mm 31 mm 1:1</p>	● — Ø 3 mm
800-021	
<p>Kugelelektrode, Schaft 2,4 mm, Einweg, steril (5 Stk.) Ball electrode, shaft 2.4 mm, single-use, sterile (5 pcs.) Électrode boule, tige 2,4 mm, usage unique, stérile (5 pcs.) Electrodo tipo bola, diam. 2,4 mm, desechable, estéril (5 uds.) Elettrodo a sfera Ø 3 mm, stelo 2,4 mm, monouso, sterile (5 pz.)</p>	
<p>Ø 2.4 mm 152 mm 115 mm 19 mm 1:1</p>	
800-028	
<p>Messerelektrode, 152 mm, Schaft 2,4 mm, Einweg, steril (5 Stk.) Knife electrode, 152 mm, shaft 2.4 mm, single-use, sterile (5 pcs.) Électrode couteau, 152 mm, tige 2,4 mm, usage unique, stérile (5 pcs.) Electrodo cuchillo, 152 mm, diam. 2,4 mm, desechable, estéril (5 uds.) Elettrodo a lama, asta 152 mm, stelo 2,4 mm, monouso, sterile (5 pz.)</p>	
<p>Ø 2.4 mm 136 mm 99 mm 1:1</p>	● — Ø 5 mm
800-030	
<p>Kugelelektrode, 136 mm, Schaft 2,4 mm, Einweg, steril (10 Stk.) Ball electrode, 136 mm, shaft 2.4 mm, single-use, sterile (10 pcs.) Électrode boule, 136 mm, tige 2,4 mm, usage unique, stérile (10 pcs.) Electr. tipo bola, 136 mm, diam. 2,4 mm, desechable, estéril (10 uds.) Elett. a sfera Ø 5 mm, asta 136 mm, stelo 2,4 mm, monouso, ster. (10pz.)</p>	
<p>Alle Elektroden mit 6-Kant-Codierung! All electrodes with hexagon coding! Toutes les électrodes avec codage hexagonal! Todos los electrodos con codificación hexagonal! Tutti gli elettrodi con codificazione esagonale!</p>	

1.3.3 Zubehör
 Accessories
 Accessoires
 Accesorios
 Accessori



 <p>1:1</p>	<p>800-000</p>	<p>Tip Cleaner, steril verpackt / 50 Stk. Tip Cleaner, sterile packing / 50 pcs. Grattoir, emballage stérile / 50 pcs. Tip Cleaner, embalaje estéril / 50 uds. Tip Cleaner, imballaggio sterile / 50 pz.</p>
 <p>1:1</p>	<p>800-006</p>	<p>Sicherheits-Köcher, steril verpackt / 100 Stk. Safety holster, sterile packing / 100 pcs. Etui porte instrument, emballage stérile / 100 pcs. Funda de protección, embalaje estéril / 100 uds. Safety holster, imballaggio sterile / 100 pz.</p>

1.4 Arthroskopie-Elektroden
 Arthroscopic electrodes
 Electrodes arthroscopiques
 Electrodo de artroscopia
 Elettrodi per artroscopia

134°C
 Autoclave
 273°F

! Sicher – Ergonomisch
 Ergonomic – Safe
 Ergonomique – Sûr
 Ergonómico – Seguro
 Ergonomico – Sicuro

4250V_p

Kabel mit orangefarbenem Sicherheitsstreifen
 Cable with orange safety stripe
 Câble avec liseré orange de sécurité
 Cable con raya de seguridad en naranja
 Cavo con strisce di sicurezza arancioni



Elektrode + Kabel = Griff
 Electrode + cable = handle
 Electrode + câble = manche
 Electrodo + cable = mango
 Elettrodo + cavo = impugnatura

6-Kant-Codierung
 Hexagon coding
 Codage hexagonal
 Codificación hexagonal
 Codificazione esagonale

Peek-Isolation
 Peek insulation
 Isolation Peek
 Aislamiento en Peek
 Isolamento in Peek

Verschiedene Ausführungen
 Various designs
 Plusieurs modèles
 Varios tipos
 Vari tipi

Empfohlene Modi bei BOWA ARC 400
 Recommended modes for the BOWA ARC 400
 Modes recommandés pour l'ARC 400 de BOWA
 Modos recomendados con BOWA ARC 400
 Modalità consigliate per BOWA ARC 400

-  Spray
-  CUT
-  COAG



<p>Nadel 90° abgewinkelt Needle angled 90° Aiguille coudée 90° Aguja acodada 90° Ago angolato 90°</p>	<p>Nadel 90° abgewinkelt Needle angled 90° Aiguille coudée 90° Aguja acodada 90° Ago angolato 90°</p>	<p>Messer 45° gekröpft Knife cranked 45° Couteau coudé 45° Cuchillo acodado 45° Lama angolata 45°</p>	<p>Tastelektrode 90° abgewinkelt Keying electrode angled 90° Electrode palpateur coudée 90° Electrodo de palpación, acodada 90° Uncino con punta, angolato 90°</p>
<p>1.5 mm 0.8 mm 136 mm 4 mm</p>	<p>4 mm 0.8 mm 134 mm 4 mm</p>	<p>4 mm 1.5 mm 135 mm 4 mm</p>	<p>3 mm 1.5 mm 136 mm 4 mm</p>
<p>1:1.5 510-108</p>	<p>1:1.5 510-109</p>	<p>1:1.5 510-110</p>	<p>1:1.5 510-112</p>

<p>Stecker, Geräteseite Plug, generator side Connecteur, côté générateur Enchufe, parte generador Spinotto, parte generatore</p>	<p>Stecker, Instrumentenseite Plug, instrument side Connecteur, côté instrument Enchufe, parte instrumento Spinotto, parte strumento</p>	<p>Passend für Gerätetyp Fitting generator type Pour générateurs type Para generadores tipo Per generatori tipo</p>	<p>REF</p>
<p>∅ 5 mm</p>	<p>∅ 4 mm</p>	<p>Erbe VIO / ICC / ACC</p>	<p>101-060 (4.5 m)</p>
<p>∅ 4 mm</p>	<p>6-Kant Hexagon coding Hexagonal Hexagonal Esagonale</p>	<p>4 mm Ø Buchse 4 mm Ø socket Fiche 4 mm Ø Casquillo 4 mm Ø Presa 4 mm Ø</p>	<p>280-035 (4.5 m)</p>
<p>∅ 8 mm</p>		<p>BOWA Erbe International Martin International Valleylab Conmed</p>	<p>370-050 (4.5 m)</p>

- 2 Kabel, Adapter und Zubehör, Zubehörtester
 Cables, adaptors and accessories, Accessory tester
 Câble, adaptateurs et accessoires, testeur d'accessoires
 Cables, adaptadores y accesorios, comprobador de accesorios
 Cavi, adattatori ed accessori, apparecchio di collaudo per accessori

<p>2 Anschlusskabel 2.1 Anschlusskabel monopolar 2.2 Anschlusskabel bipolar 2.3 COMFORT Anschlusskabel 2.3.1 COMFORT Anschlusskabel monopolar 2.3.2 COMFORT Anschlusskabel bipolar 2.4 Adapter 2.4.1 Adapter monopolar 2.4.2 Adapter BOWA ARC 2.5 Prüfgerät</p>	<p>2 Connecting cables 2.1 Connecting cables monopolar 2.2 Connecting cables bipolar 2.3 COMFORT Connecting cables 2.3.1 COMFORT Connecting cables monopolar 2.3.2 COMFORT Connecting cables bipolar 2.4 Adaptors 2.4.1 Adaptors monopolar 2.4.2 Adaptors BOWA ARC 2.5 Testing device</p>	<p>2 Câbles de raccordement 2.1 Câbles de raccordement monopolaires 2.2 Câbles de raccordement bipolaires 2.3 COMFORT Câbles de raccordement 2.3.1 COMFORT Câbles de raccordement monopolaires 2.3.2. COMFORT Câbles de raccordement bipolaires 2.4 Adaptateurs 2.4.1 Adaptateurs monopolaires 2.4.2. Adaptateurs BOWA ARC 2.5 Testeur</p>
<p>2 Cables de conexión 2.1 Cables de conexión monopolares 2.2 Cables de conexión bipolares 2.3 COMFORT Cables de conexión 2.3.1 COMFORT Cables de conexión monopolares 2.3.2 COMFORT Cables de conexión bipolares 2.4 Adaptadores 2.4.1 Adaptadores monopolares 2.4.2 Adaptadores BOWA ARC 2.5 Comprobador</p>	<p>2 Cavi di collegamento 2.1 Cavi di collegamento monopolari 2.2 Cavi di collegamento bipolari 2.3 COMFORT Cavi di collegamento 2.3.1 COMFORT Cavi di collegamento monopolari 2.3.2 COMFORT Cavi di collegamento bipolari 2.4 Adattatori 2.4.1 Adattatori monopolari 2.4.2 Adattatori BOWA ARC 2.5 Apparecchio di collaudo</p>	

<p>Alle wiederverwendbaren Instrumente werden im unsterilen Zustand angeliefert und können bei 134 °C / 20 min sterilisiert werden. Alle Einmalprodukte sind nicht für den mehrmaligen Gebrauch vorgesehen. Für die allgemeine Wischdesinfektion können handelsübliche Mittel verwendet werden. Für unsachgemäße Reinigung, Sterilisation und Anwendung kann seitens BOWA keine Haftung übernommen werden. Die Produkte tragen das CE Zeichen nach Richtlinie 93 / 42 / EWG</p>	<p>All reusable instruments are supplied in an unsterile state and can be sterilised at 134 °C for 20 min. All single-use products are not intended for multiple usage. Commercially available agents can be used for general wiping and disinfection. BOWA can accept no liability for improper cleaning, sterilisation and use. The products are certified according to 93 / 42 / EEC</p>	<p>Tous les instruments réutilisables sont livrés non stériles et peuvent être stérilisés à 134 °C / 20 min. Aucun produit à usage unique n'est destiné à être réutilisé. Des produits courants disponibles dans le commerce peuvent être utilisés pour un lavage désinfectant général. BOWA exclue toute responsabilité quant au nettoyage, à la stérilisation ou à l'utilisation non conformes ou inappropriés. Les produits sont certifiés selon la directive 93 / 42 / CEE</p>
---	---	--



Todos los instrumentos reutilizables se suministran en estado no estéril y deben ser esterilizados a 134 °C / 20 min.

Todos los productos desechables no son previstos para reutilización.

Para la desinfección superficial general pueden utilizarse productos comerciales corrientes.

BOWA no asume ningún tipo de responsabilidad por la limpieza, la esterilización y la utilización indebida.

Los productos están certificados según la norma 93 / 42 / CEE

Tutti gli strumenti riutilizzabili sono forniti non sterili e possono essere sterilizzati per 20 min a 134 °C.

Tutti i prodotti monouso sono destinati a non essere riutilizzati.

Per la pulizia e la disinfezione generale è possibile utilizzare i prodotti in commercio.

BOWA non si assume alcuna responsabilità per la pulizia, la sterilizzazione e l'uso non conforme.

I prodotti sono certificati in accordance con 93 / 42 / CEE

Anschlusskabel
Connecting cables
Câbles de raccordement
Cables de conexión
Cavi di collegamento



gold product
design award
2010



reddot
winner
2010



good design
award
2010



Mehrfach preisgekröntes Design
Multiple award-winning design
Design primé à plusieurs reprises
Diseño galardonado con diversos premios
Design pluripremiato

Sichere Identifikation und einfache Ersatzbeschaffung
Safe identification and easy procurement of spare parts
Identification sûr et approvisionnement facilité
Identificación segura y fácil adquisición de recambios
Identificazione sicura e semplice approvvigionamento
dei ricambi

Spannungssicherheit bis 6000 Vp
Voltage safety up to 6000 Vp
Sécurité de tension jusqu'à 6000 Vp
Seguridad de tensión hasta 6000 Vp
Sicurezza da tensioni fino a 6000 Vp

Hochflexibles und sicheres Arbeiten
Highly flexible and safe working
Travail hautement flexible et sûr
Alta flexibilidad y seguridad en el trabajo
Lavoro altamente flessibile e sicuro

Kabel mit orangefarbenem Sicherheitsstreifen
Cable with orange safety stripe
Câble avec liseré orange de sécurité
Cable con raya de seguridad en naranja
Cavo con strisce di sicurezza arancioni

Gleichbleibend sicheres Steckverhalten
Consistently safe plug-in behaviour
Fonctionnement sûr et constant
Conexión estable y segura
Innesto sempre sicuro

Knickschutz
Bend protection
Manchon de protection
Protección contra dobleces
Protezione anti piego

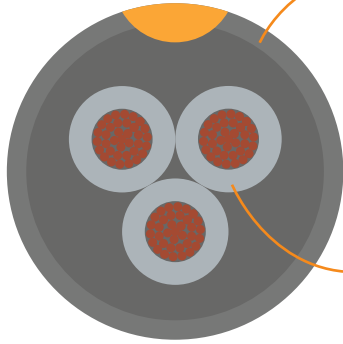

Ideale Reinigungseigenschaften
 Ideal cleaning properties
 Propriétés idéales de nettoyage
 Propiedades de limpieza idóneas
 Proprietà di pulizia ideali

Korrosionsschutz
 Corrosion protection
 Protection anticorrosion
 Protección anticorrosión
 Protezione dalla corrosione



Extreme Langlebigkeit
 Highly durable
 Durabilité extraordinaire
 Duración extrema
 Estrema durata



Besonderer Berührungsschutz
 Special touch protection
 Protection particulière contre les contacts
 Especial protección contra el contacto
 Particolare protezione dal contatto



Empfohlene Modi bei BOWA ARC 400
 Recommended modes for the BOWA ARC 400
 Modes recommandés pour l'ARC 400 de BOWA
 Modos recomendados con BOWA ARC 400
 Modalità consigliate per BOWA ARC 400



Bipolar COAG



Bipolar CUT

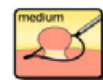

GastroCut



Laparoscopia COAG
 Laparoscopy COAG
 Laparoscopia COAG
 Laparoscopia COAG
 Laparoscopia COAG















Pinzette
 Forceps
 Pince
 Pinza
 Pinza

2.1 Anschlusskabel monopolar
 Connecting cables monopolar
 Câbles de raccordement monopolaires
 Cables de conexión monopolares
 Cavi di collegamento monopolari

134°C
 Autoclave
 273°F

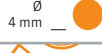

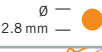





6000V_p

Geräteseitig / At the unit / Côté appareil / En el lado del aparato / Parte generatore

						
						
		4 mm Ø Buchse 4 mm Ø socket Fiche 4 mm Ø Casquillo 4 mm Ø Presa 4 mm Ø	BOWA Erbe International Martin International Valleylab Conmed	Erbe VIO / ICC / ACC	Martin	
Instrumentenseitig / At the instrument / Côté instrument / Lado del instrumento / Parte strumento	4-mm-Instrumente 4 mm instruments Instruments 4 mm Instrumentos de 4 mm Strumenti da 4 mm		280-050 (4.5 m)	360-050 (4.5 m)	101-051 (4.5 m)	-
	Resektoskopie Resectoscopy Résectoscope Resectoscopia Resettoscopia		405-045 (4.5 m)	375-045 (4.5 m)	106-045 (4.5 m)	-
	Endoskopie Endoscopy Endoscopie Endoscopia Endoscopia		431-045 (4.5 m)	331-045 (4.5 m)	131-045 (4.5 m)	-
	Endoskopie Endoscopy Endoscopie Endoscopia Endoscopia		432-045 (4.5 m)	332-045 (4.5 m)	132-045 (4.5 m)	285-050* (4.5 m)
	U.K. Monopolare Pinzetten / Griffe UK Monopolar forceps / grips U.K. Pincers Pinza monopolare / mangos U.K. U.K. Pinze / manipoli monopolari		280-031 (4.5 m)	365-030 (4.5 m)	-	-
		* Nur original Martin-Handgriffe * Only genuine Martin handles * Seulement pour manches Martin originaux		* Solo mangos originales Martin * Solo per manipoli Martin originali		

2.2 Anschlusskabel bipolar
 Connecting cables bipolar
 Câbles de raccordement bipolaires
 Cables de conexión bipolares
 Cavi di collegamento bipolari

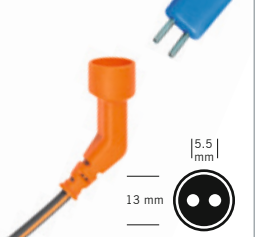
134°C
 Autoclave
 273°F

Geräteseitig / At the unit / Côté appareil / En el lado del aparato / Parte generatore						
						
	BOWA Erbe International* Martin International Valleylab Conmed	Erbe VIO / ICC / ACC Erbe T-Serie	Erbe VIO International*	Martin		
Instrumentenseitig / At the instrument / Côté instrument / Lado del instrumento / Parte strumento	BOWA-Pinzette Europäischer Flachstecker BOWA forceps Euro- pean flat connector Pince BOWA Fiche plate européenne Pinza BOWA conector europeo plano Pinze BOWA connettore piatto europeo 550V_P		351-040 (4.5 m)	101-040 (4 m)	353-040 (4.5 m)	287-040 (4.5 m)
	EU-Pinzette Europäischer Flachstecker EU forceps European flat connector Pince UE Fiche plate européenne Pinza UE conector europeo plano Pinze UE connettore piatto europeo 550V_P		351-051 (4.5 m)	101-000 (4 m)	353-050 (4.5 m)	287-050 (4.5 m)
	US-Pinzette US forceps Pince US Pinza E.E.U.U. Pinze USA 550V_P		351-045 (4.5 m)	101-045 (4 m)	353-045 (4.5 m)	287-045 (4.5 m)
	BIZZER®, Ethicon Bipolare Scheren: Bipolar scissors: Ciseaux bipolaires Tijeras bipolares: Forbici bipolari: 300V_P		378-045 (4.5 m)	378-145 (4.5 m)	-	378-245 (4.5 m)
	Lawton Bipolare Schere Bipolar scissors Ciseaux bipolaires Tijera bipolar Forbici bipolari 300V_P		401-051 (4.5 m)	401-052 (4.5 m)	-	-
		* Abhängig von der jeweiligen Buchsenkonfiguration * Depending on the respective socket configuration * Dépend de la configuration de prise respective	* Según la configuración de enchufes respectiva * In funzione della rispettiva configurazione della presa			

2.2 Anschlusskabel bipolar
 Connecting cables bipolar
 Câbles de raccordement bipolaires
 Cables de conexión bipolares
 Cavi di collegamento bipolari

550V_p

Geräteseitig / At the unit / Côté appareil /
 En el lado del aparato / Parte generatore



Valleylab-Geräte mit Autobipolar-Modus!
 Für handgeschaltete Bipolar-Pinzetten.
 Valleylab units with autobipolar mode!
 For handswitching bipolar forceps.
 Générateurs Valleylab à mode auto-bipolaire! Pour pinces digitales.
 Generadores Valleylab a modo autobipolar!
 Para pinzas bipolares con interruptor manual.
 Generatori Valleylab con modalità autobipolare!
 Per pinze bipolari ad azionamento manuale.

Instrumentenseitig / At the instrument / Côté instrument / Lado del instrumento / Parte strumento

EU-Pinzette
 Europäischer Flachstecker
 EU forceps
 European flat connector
 Pince UE
 Fiche plate européenne
 Pinza europea
 conector europeo plano
 Pinze UE
 connettore piatto europeo



355-030 (3 m)

BOWA-Pinzette
 Europäischer Flachstecker
 BOWA forceps European flat
 connector
 Pince BOWA Fiche
 plate européenne
 Pinza BOWA
 conector europeo plano
 Pinze BOWA
 connettore piatto europeo



355-031 (3 m)

2.3.1 COMFORT Anschlusskabel monopolar
 Connecting cables monopolar
 Câbles de raccordement monopolaires
 Cables de conexión monopolares
 Cavi di collegamento monopolari











6000V_p

Geräteseitig / At the unit / Côté appareil /
 En el lado del aparato / Parte generatore



● —
 ● 31.75 mm
 ● —



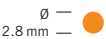







COMFORT
 Anschlusskabel monopolar
 Connecting cables monopolar
 Câbles de raccordement monopolaires
 Cables de conexión monopolares
 Cavi di collegamento monopolari

Instrumentenseitig / At the instrument / Côté instrument / Lado del instrumento / Parte strumento	Resektoskopie Resectoscopy Résectoscope Resectoscopia Resettoscopia			106-145 (4.5 m)		
	Resektion CUT Resection CUT Résection CUT Resección CUT Resezione CUT	Wolf / Storz		106-245 (4.5 m)		
	Resektion COAG Resection COAG Résection COAG Resección COAG Resezione COAG	Storz			106-345 (4.5 m)	
	Olympus	Olympus			106-345 (4.5 m)	
Endoskopie Endoscopy Endoscopia Endoscopia Endoscopia		GastroCut Pap		GastroCut Pol		131-145 (4.5 m)

2.3.2 COMFORT Anschlusskabel bipolar
 Connecting cables bipolar
 Câbles de raccordement bipolaires
 Cables de conexión bipolares
 Cavi di collegamento bipolari



Geräteseitig / At the unit / Côté appareil / En el lado del aparato / Parte generatore

COMFORT Anschlusskabel bipolar Connecting cables bipolar Câbles de raccordement bipolaires Cables de conexión bipolares Cavi di collegamento bipolari

Instrumentenseitig / At the instrument / Côté instrument / Lado del instrumento / Parte strumento	Resektoskopie Resectoscopy Résectoscope Resectoscopia Resettoscopia	Wolf 	354-145 (4.5 m)	
	 Resektion CUT Resection CUT Résection CUT Resección CUT Resezione CUT	 Resektion COAG Resection COAG Résection COAG Resección COAG Resezione COAG	Storz 	352-145 (4.5 m)
		Olympus 	355-145 (4.5 m)	
	 Pinzette Forceps Pince Pinza Pinza	BOWA-Pinzette Europäischer Flachstecker BOWA forceps European flat connector Pince BOWA Fiche plate européenne Pinza BOWA conector europeo plano Pinze BOWA connettore piatto europeo		101-140 (4.5 m)
		 Laparoskopie Laparoscopy Laparoscopia Laparoscopia	 Laparoskopie Mikro Laparoscopy Micro Laparoscopia Micro Microlaparoscopia Laparoscopia Micro	Storz 
				

2.4.1 Adapter
 Adaptors
 Adaptateurs
 Adaptadores
 Adattatori

134°C
 Autoclave
 273°F

BOWA
 Zubehör
 Accessories
 Accessoires
 Accesorios
 Accessori

Schraube
 Screw
 Vis
 Tornillo
 Vite



6000V_p

2–4 mm
 Variabel
 Variable
 Variable
 Variable
 Variable





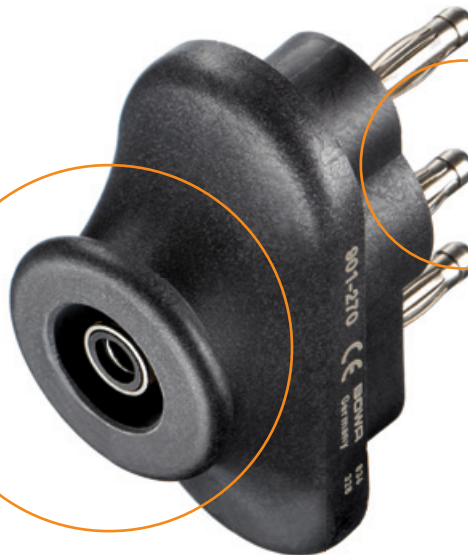

Für BOWA ARC Generatoren
 For BOWA ARC generators
 Pour générateurs BOWA ARC
 Para generadores BOWA ARC
 Per generatori BOWA ARC

Ring
 Ring
 Anneau
 Anilla
 Anello
 Pull-off

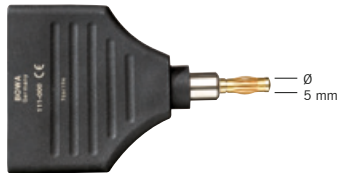

2.4.1 Adapter Adaptors Adaptateurs Adaptadores Adattatori

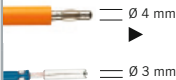
Adapter monopolar Adaptors monopolar Adaptateurs monopolaires Adaptadores monopolares Adattatori monopolari			
Für handgeschaltete Griffe und 3-Pin-Stecker For the connection of fingerswitch handles with 3-pin plug Pour le raccordement de manches digitaux avec connecteur 3 broches Para la conexión de mangos con pulsadores y enchufe 3-pin Per il collegamento di manopoli con pulsanti e attacco a 3-pin		111-000	Für Erbe VIO / ICC / ACC Generatoren For Erbe VIO / ICC / ACC generators Pour générateurs Erbe VIO / ICC / ACC Para generadores Erbe VIO / ICC / ACC Per generatori Erbe VIO / ICC / ACC
		222-000	Für Martin, Generatoren For Martin, generators Pour générateurs Martin Para generadores Martin Per generatori Martin

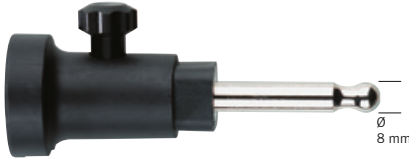
Für fußgeschaltete Instrumente For footswitching instruments Pour instruments à commande à pédale Para instrumentos activados por pedal Per strumenti attivati a pedale			
		111-001	Für Erbe VIO / ICC / ACC Generatoren For Erbe VIO / ICC / ACC generators Pour générateurs Erbe VIO / ICC / ACC Para generadores Erbe VIO / ICC / ACC Per generatori Erbe VIO / ICC / ACC
		333-001	BOWA ERBE International Martin International Valleylab Conmed

Adapter bipolar Adaptors bipolar Adaptateurs bipolaires Adaptadores bipolares Adattatori bipolari			
BOWA Bipolare Kabel (Typ Valleylab / Conmed 2-pin) Bipolar cables (type Valleylab / Conmed 2-pin) Câbles bipolaires (type Valleylab / Conmed 2-pin) Cables bipolares (tipo Valleylab / Conmed 2-pin) Cavi bipolari (tipo Valleylab / Conmed 2-pin)		340-000	Für Erbe Generatoren For Erbe generators Pour générateurs Erbe Para generadores Erbe Per generatori Erbe
<div style="border: 1px solid orange; padding: 5px; display: inline-block;">1000V_p</div>			

2.4.2 Adapter BOWA ARC
 Adaptors BOWA ARC
 Adaptateurs BOWA ARC
 Adaptadores BOWA ARC
 Adattatori BOWA ARC

Adapter monopolar Adaptors monopolar Adaptateurs monopolaires Adaptadores monopolares Adattatori monopolari			
Für Erbe VIO / ICC / ACC Zubehör For Erbe VIO / ICC / ACC Accessories Pour accessoires Erbe VIO / ICC / ACC Para accesorios Erbe VIO / ICC / ACC Per accessori Erbe VIO / ICC / ACC		901-250	BOWA ARC 250 / 303 mit Europa Option with Europe Option avec option Europe con Europa opción con Europa opzione
Für Martin Zubehör For Martin Accessories Pour accessoires Martin Para accesorios Martin Per accessori Martin		901-270	BOWA ARC 350 / 400 BOWA ARC 250 / 303 mit Europa Option with Europe Option avec option Europe con Europa opción con Europa opzione

Adapter bipolar Adaptors bipolar Adaptateurs bipolaires Adaptadores bipolares Adattatori bipolari			
Für Erbe VIO / ICC / ACC Zubehör For Erbe VIO / ICC / ACC Accessories Pour accessoires Erbe VIO / ICC / ACC Para accesorios Erbe VIO / ICC / ACC Per accessori Erbe VIO / ICC / ACC		901-210	Für BOWA ARC 250/303/350/400 Generatoren For BOWA ARC 250/303/350/400 generators Pour générateurs BOWA ARC 250/303/350/400 Para generadores BOWA ARC 250/303/350/400 Per generatori BOWA ARC 250/303/350/400
Für Martin Zubehör For Martin Accessories Pour accessoires Martin Para accesorios Martin Per accessori Martin		901-220	

1000V_p

1000V_p

2.5 Prüfgerät
 Testing device
 Testeur
 Comprobador
 Apparecchio di collaudo

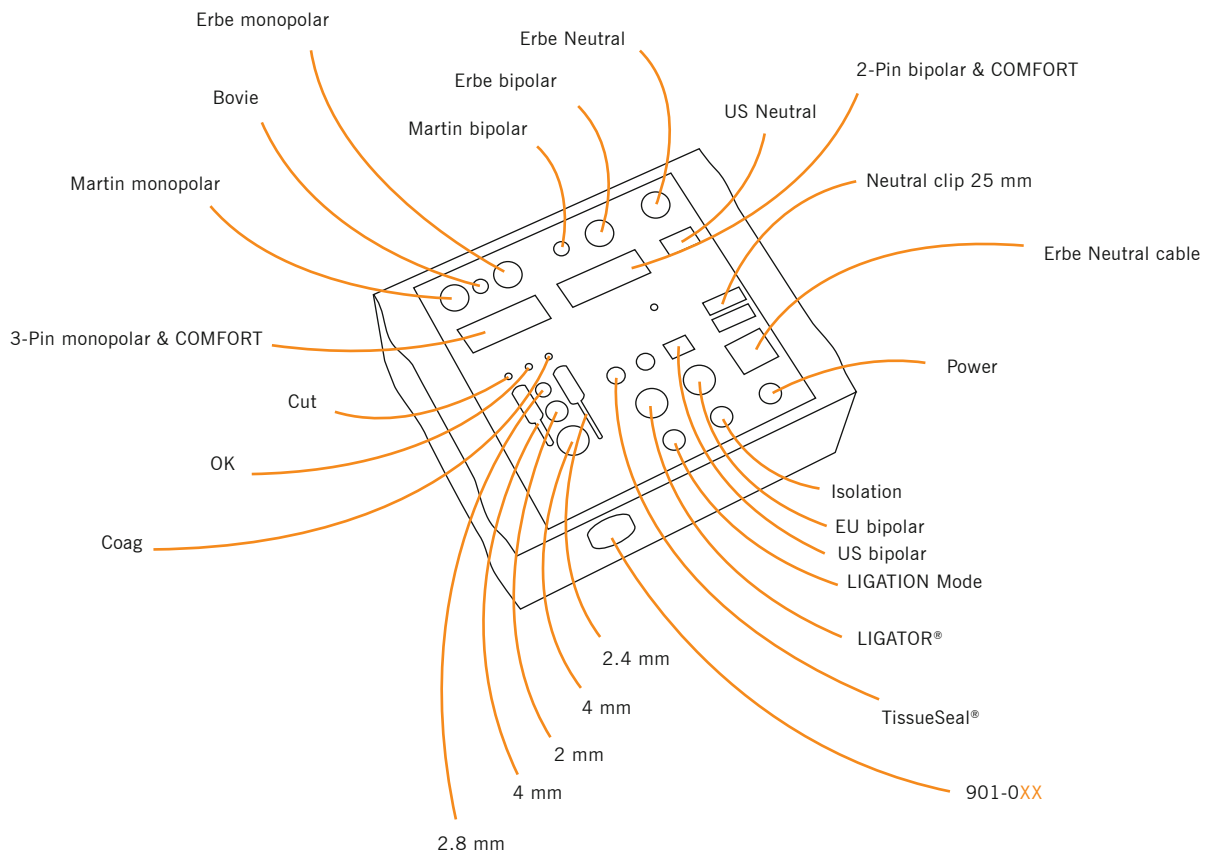
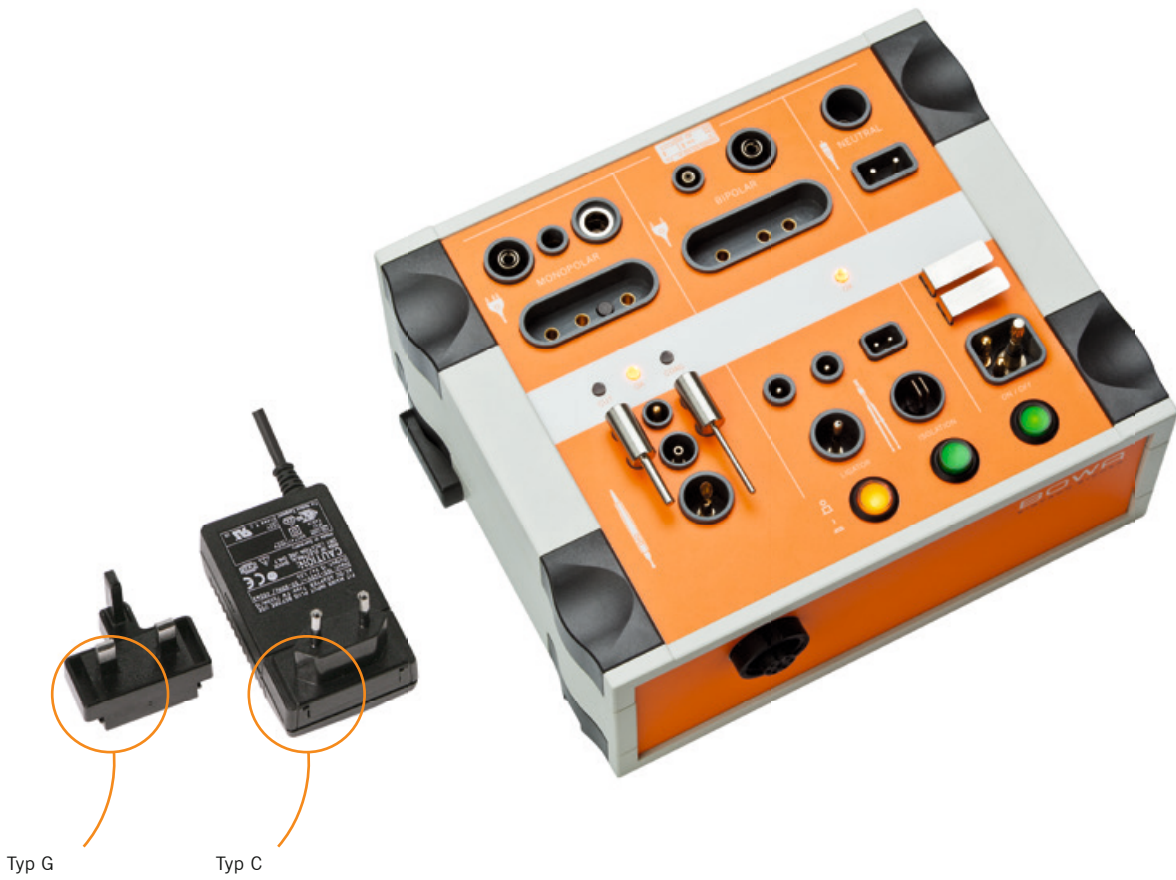



050-230

Prüfgerät für Handgriffe und Kabel inklusive Trafo-Teil, 100–240 V AC

- Prüft zuverlässig den elektrischen Durchgang und die Funktion der Schalter
- Erspart unnötiges Sterilisieren defekter Teile
- Schafft mehr Sicherheit im OP
- Prüft Handgriffe passend für unterschiedliche Generatoren
- Stellt eine äußerst preiswerte Prüfvorrichtung dar

Das Prüfgerät ist geeignet zur Funktionsprüfung von:

- Monopolarkabel (3-Pin, Martin, Bovie und ERBE) und Handgriffe mit 2.4 mm und 4 mm Elektrodenaufnahmen
- Bipolarkabel (2-Pin, Martin, Erbe)
- Neutralelektrodenkabel (2-Pin, Martin, Erbe)
- TissueSeal®-Kabel
- LIGATOR®-Kabel
- NightKNIFE®-Kabel
- BOWA-Fußschalter 901-011, 901-021, 901-031 und 901-032
- BOWA COMFORT Kabel

Testing device for electrode handles and cables including transformer, 100–240 V A.C.

- Reliable testing of electrical circuit and function of fingerswitches
- No waste of time by sterilizing faulty parts
- More safety in the OR
- Tests electrode handles for various generator types
- A simple to use testing unit at extremely low costs

The testing device is adequate for the functional test of:

- Monopolar cables (3-Pin, Martin, Bovie and ERBE) and handles with an electrode adapter of 2.4 mm and 4 mm
- Bipolar cables (2-Pin, Martin, Erbe)
- Return plates cables (2-Pin, Martin, Erbe)
- TissueSeal® cables
- LIGATOR® cables
- NightKNIFE® cables
- BOWA foot switches 901-011, 901-021, 901-031 and 901-032
- BOWA COMFROT cables

Testeur pour manches de bistouri et câbles, transformateur 100–240 V AC inclus

- Testeur fiable du courant électrique et de la fonction des interrupteurs
- Évite la stérilisation de pièces défectueuses
- Plus de sécurité dans la salle d'opération
- Teste des accessoires pour plusieurs types de générateurs
- Utilisation simple, à un prix extrêmement bas

Le testeur est conçu pour contrôler le fonctionnement de:

- Câble monopolaire (3 broches, Martin, Bovie et Erbe) et manche pour électrode de 2.4 ou 4 mm
- Câble Bipolaire (2 broches, Martin, Erbe)
- Câble de plaque neutre (2 broches, Martin, Erbe)
- Câble TissueSeal®
- Câble LIGATOR®
- Câble NightKNIFE®
- Pédales BOWA 901-011, 901-021, 901-031 et 901-032
- Câble BOWA COMFORT

Comprobador para mangos y cables incluso transformador 100–240 V CA

- Comprueba fiablemente la corriente y la función de los interruptores
- Evita la esterilización de piezas defectuosas
- Para más seguridad en el quirófano
- Comprueba mangos para diferentes tipos de generadores
- Utilización fácil y de costos muy favorables

El comprobador es previsto para controlar las siguientes funciones:

- Cable monopolar (3-pin, Martin, Bovie y Erbe) y mangos porta electrodos de 2.4 o 4 mm
- Cable bipolar (2-pin, Martin, Erbe)
- Cable para electrodo neutro (2-pin, Martin, Erbe)
- Cable TissueSeal®
- Cable LIGATOR®
- Cable NightKNIFE®
- Interruptores de pie BOWA 901-011, 901-021, 901-031 y 901-032
- Cable BOWA COMFORT

Apparecchio di collaudo per manipoli e cavi, trasformatore 100–240 V AC incluso

- Controlla attendibilmente la conduzione elettrica ed il funzionamento dei pulsanti
- Eventuali sterilizzazioni di prodotti difettosi vengono impediti
- Più sicurezza nella sala operatoria
- Collauda manipoli per diversi tipi di generatori
- È un apparecchio di prova e verifica molto economico

L'apparecchio è adatto per il collaudo funzionale:

- Cavi monopolari (3-Pin, Martin, Bovie e ERBE) e manipoli con adattatori per elettrodi di 2.4 mm e 4 mm
- Cavi bipolari (2-Pin, Martin, Erbe)
- Cavi elettrodi neutrali (2-Pin, Martin, Erbe)
- Cavo TissueSeal®
- Cavo LIGATOR®
- Cavo NightKNIFE®
- BOWA interruttori a pedale 901-011, 901-021, 901-031 e 901-032
- Cavi BOWA COMFORT

3 Instrumente für Laparoskopie – MetraLOOP®, LapHaken, ErgoLAP, ERGO 300
 Instruments for laparoscopy – MetraLOOP®, Lap. hook, ErgoLAP, ERGO 300
 Instruments pour laparoscopie – MetraLOOP®, Crochet, ErgoLAP, ERGO 300
 Instrumentos para laparoscopia – MetraLOOP®, Gancho lap, ErgoLAP, ERGO 300
 Strumenti per laparoscopia – MetraLOOP®, uncinini laparoscopici,
 ErgoLAP, ERGO 300

3.1 MetraLOOP®	3.1 MetraLOOP®	3.1 MetraLOOP®
3.2 Elektroden für die Laparoskopie	3.2 Electrodes for laparoscopic surgery	3.2 Electrodes pour la coelioscopie
3.3 ErgoLAP monopolar	3.3 ErgoLAP monopolar	3.3 ErgoLAP monopolaires
3.4 ErgoLAP bipolar	3.4 ErgoLAP bipolar	3.4 ErgoLAP bipolaires
3.5 ERGO bipolar	3.5 ERGO bipolar	3.5 ERGO bipolaires
3.6 ERGO 300 Morzellator	3.6 ERGO 300 Morcellator	3.6 ERGO 300 Morcellateur
3.1 MetraLOOP®	3.1 MetraLOOP®	
3.2 Electrodo de laparoscopia	3.2 Elettrodi per laparoscopia	
3.3 ErgoLAP monopolar	3.3 ErgoLAP monopolari	
3.4 ErgoLAP bipolar	3.4 ErgoLAP bipolari	
3.5 ERGO bipolar	3.5 ERGO bipolari	
3.6 ERGO 300 Morcelador	3.6 ERGO 300 Morcellatore	

<p>Alle wiederverwendbaren Instrumente werden im unsterilen Zustand angeliefert und können bei 134 °C / 20 min sterilisiert werden.</p> <p>Alle Einmalprodukte sind nicht für den mehrmaligen Gebrauch vorgesehen.</p> <p>Für die allgemeine Wischdesinfektion können handelsübliche Mittel verwendet werden.</p> <p>Für unsachgemäße Reinigung, Sterilisation und Anwendung kann seitens BOWA keine Haftung übernommen werden.</p> <p>Die Produkte tragen das CE Zeichen nach Richtlinie 93 / 42 / EWG</p>	<p>All reusable instruments are supplied in an unsterile state and can be sterilised at 134 °C for 20 min.</p> <p>All single-use products are not intended for multiple usage.</p> <p>Commercially available agents can be used for general wiping and disinfection.</p> <p>BOWA can accept no liability for improper cleaning, sterilisation and use.</p> <p>The products are certified according to 93 / 42 / EEC</p>	<p>Tous les instruments réutilisables sont livrés non stériles et peuvent être stérilisés à 134 °C / 20 min.</p> <p>Aucun produit à usage unique n'est destiné à être réutilisé.</p> <p>Des produits courants disponibles dans le commerce peuvent être utilisés pour un lavage désinfectant général.</p> <p>BOWA exclue toute responsabilité quant au nettoyage, à la stérilisation ou à l'utilisation non conformes ou inappropriés.</p> <p>Les produits sont certifiés selon la directive 93 / 42 / CEE</p>
---	---	--



Todos los instrumentos reutilizables se suministran en estado no estéril y deben ser esterilizados a 134 °C / 20 min.

Todos los productos desechables no son previstos para reutilización.

Para la desinfección superficial general pueden utilizarse productos comerciales corrientes.

BOWA no asume ningún tipo de responsabilidad por la limpieza, la esterilización y la utilización indebida.

Los productos están certificados según la norma 93 / 42 / CEE

Tutti gli strumenti riutilizzabili sono forniti non sterili e possono essere sterilizzati per 20 min a 134 °C.

Tutti i prodotti monouso sono destinati a non essere riutilizzati.

Per la pulizia e la disinfezione generale è possibile utilizzare i prodotti in commercio.

BOWA non si assume alcuna responsabilità per la pulizia, la sterilizzazione e l'uso non conforme.

I prodotti sono certificati in accordo con la norma 93 / 42 / CEE

3.1 MetraLOOP®

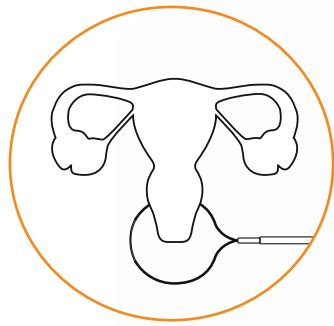

Laparoskopische suprazervikale Hysterektomie
Laparoscopic supracervical hysterectomy
Hystérectomie supracervicale laparoscopique
Histerectomía supracervical laparoscópica
Isterectomia supracervicale laparoscopica

1000V_p

Teflon-Isolation
Teflon insulation
Isolation Teflon
Aislamiento Teflón
Isolazione in Teflon

Keramik-Isolation
Ceramics insulation
Isolation céramique
Aislamiento en cerámica
Isolamento in ceramica

Einfache Montage
Easy assembling
Montage simple
Montaje fácil
Montaggio semplice

Verschiedene Ausführungen Ø 100 / 175 mm
Various designs Ø 100 / 175 mm
Plusieurs modèles Ø 100 / 175 mm
Varios tipos Ø 100 / 175 mm
Vari tipi Ø 100 / 175 mm

Optimiert für BOWA ARC 400 MetraLOOP® Modus
Designed for ARC 400 MetraLOOP® Mode
Optimisé pour BOWA ARC 400 Mode MetraLOOP®
Optimizado para BOWA ARC 400 Modo MetraLOOP®
Ottimizzato per BOWA ARC 400 modalità MetraLOOP®

BOWA
ARC 400

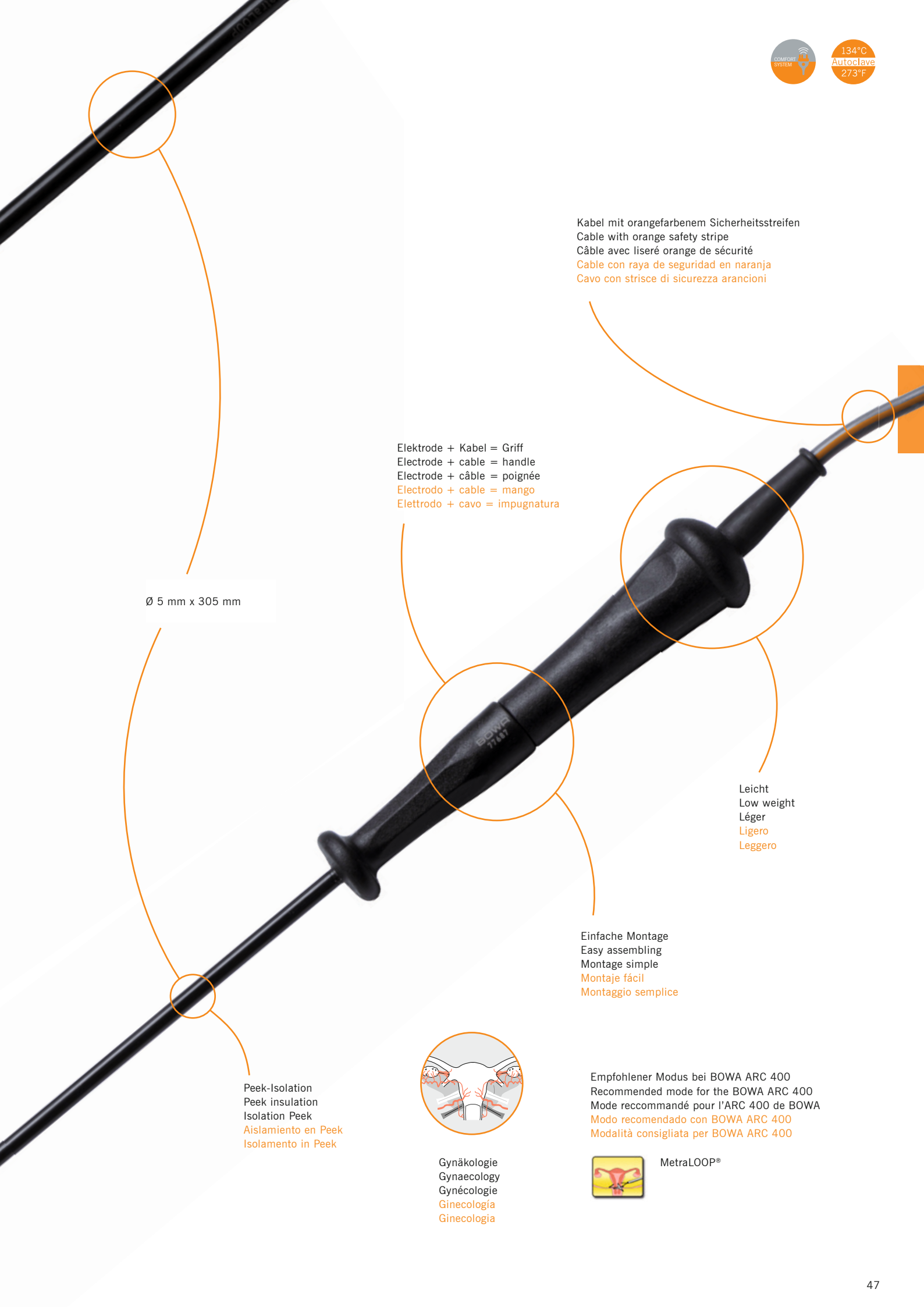

Kabel mit orangefarbenem Sicherheitsstreifen
 Cable with orange safety stripe
 Câble avec liseré orange de sécurité
 Cable con raya de seguridad en naranja
 Cavo con strisce di sicurezza arancioni

Elektrode + Kabel = Griff
 Electrode + cable = handle
 Electrode + câble = poignée
 Electrodo + cable = mango
 Elettrodo + cavo = impugnatura

Ø 5 mm x 305 mm

Leicht
 Low weight
 Léger
 Ligero
 Leggero

Einfache Montage
 Easy assembling
 Montage simple
 Montaje fácil
 Montaggio semplice

Peek-Isolation
 Peek insulation
 Isolation Peek
 Aislamiento en Peek
 Isolamento in Peek

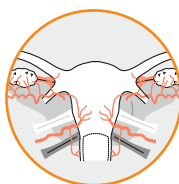



Gynäkologie
 Gynaecology
 Gynécologie
 Ginecologia
 Ginecologia









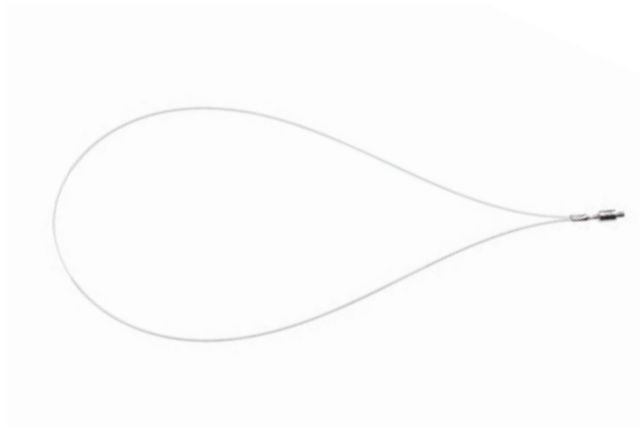

MetraLOOP®

Empfohlener Modus bei BOWA ARC 400
 Recommended mode for the BOWA ARC 400
 Mode recommandé pour l'ARC 400 de BOWA
 Modo recomendado con BOWA ARC 400
 Modalità consigliata per BOWA ARC 400

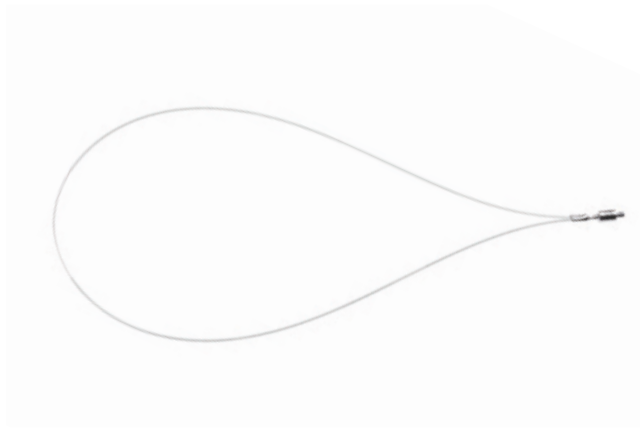

520-110	<p>MetraLOOP®, Innenschaft, Außenschaft MetraLOOP®, inner shaft, outer shaft MetraLOOP®, conduit interne & externe MetraLOOP®, tija interior, tija exterior MetraLOOP®, tubo interno, tubo esterno</p>
520-115	<p>MetraLOOP®, COMFORT, Innenschaft, Außenschaft, Kabel 4.5 m MetraLOOP®, COMFORT, inner shaft, outer shaft, cable 4.5 m MetraLOOP®, COMFORT, conduit interne & externe, câble 4.5 m MetraLOOP®, COMFORT, tija interior, tija exterior, cable 4.5 m MetraLOOP®, COMFORT, tubo interno, tubo esterno, cavo 4.5 m</p> 
520-114	<p>MetraLOOP®, Außenschaft MetraLOOP®, outer shaft MetraLOOP®, conduit externe MetraLOOP®, tija exterior MetraLOOP®, tubo esterno</p>
520-113	<p>MetraLOOP®, Innenschaft MetraLOOP®, inner shaft MetraLOOP®, conduit interne MetraLOOP®, tija interior MetraLOOP®, tubo interno</p>
520-116	<p>MetraLOOP®, COMFORT, Innenschaft, Kabel 4.5 m MetraLOOP®, COMFORT, inner shaft, cable 4.5 m MetraLOOP®, COMFORT, conduit interne, câble 4.5 m MetraLOOP®, COMFORT, tija interior, cable 4.5 m MetraLOOP®, COMFORT, tubo interno, cavo 4.5 m</p> 



	<p>520-117</p>	<p>MetraLOOP®, Ersatzschlingen Ø 100 mm, Einweg, steril / 10 Stk. MetraLOOP®, spare loops, Ø 100 mm, single use, sterile / 10 pcs. MetraLOOP®, anse de rechange, Ø 100 mm, Usage Unique, stérile / 10 pcs. MetraLOOP®, asas de recambio Ø 100 mm, desechable, estéril / 10 uds. MetraLOOP®, anse di ricambio Ø 100 mm, monouso, sterile / 10 pz.</p> <p style="text-align: center;"> STERILE</p>
	<p>520-118</p>	<p>MetraLOOP®, Ersatzschlingen Ø 175 mm, Einweg, steril / 10 Stk. MetraLOOP®, spare loops, Ø 175 mm, single use, sterile / 10 pcs. MetraLOOP®, anse de rechange, Ø 175 mm, Usage Unique, stérile / 10 pcs. MetraLOOP®, asas de recambio Ø 175 mm, desechable, estéril / 10 uds. MetraLOOP®, anse di ricambio Ø 175 mm, monouso, sterile / 10 pz.</p> <p style="text-align: center;"> STERILE</p>
 <p style="text-align: right;">∅ 8 mm</p>	<p>BOWA Erbe International Martin International Valleylab Conmed</p>	<p>370-050 (4.5 m)</p>
 <p style="text-align: right;">∅ 4 mm</p>	 <p style="text-align: right;">∅ 4 mm</p> <p>6-Kant Hexagon coding Hexagonal Hexagonal Esagonale</p>	<p>Erbe T-Serie und andere mit 4 mm Ø Buchse Erbe T series and others with 4 mm Ø socket Erbe série T et autres avec fiche 4 mm Ø Erbe serie T y otros con casquillo 4 mm Ø Per Erbe serie T ed altri con boccola da 4 mm Ø</p> <p>280-035 (4.5 m)</p>
 <p style="text-align: right;">∅ 5 mm</p>	<p>Erbe VIO/ICC/ACC</p>	<p>101-060 (4.5 m)</p>

3.2 Elektroden für die Laparoskopie
 Electrodes for laparoscopic surgery
 Electrodes pour la cœlioscopie
 Electrodo de laparoscopia
 Elettrodi per laparoscopia

134°C
 Autoclave
 273°F



Effizient – Ergonomisch – Langlebig
 Efficient – Ergonomic – Durable
 Efficaces – Ergonomiques – Durables
 Eficiente – Ergonómico – Durable
 Efficiente – Ergonomico – Durevole

4250V_p

Kombinierbar mit ErgoPEN 4 mm
 Can be combined with ErgoPEN 4 mm
 Combinable avec ErgoPEN 4 mm
 Combinabile con ErgoPEN 4 mm
 Combinabile con ErgoPEN 4 mm

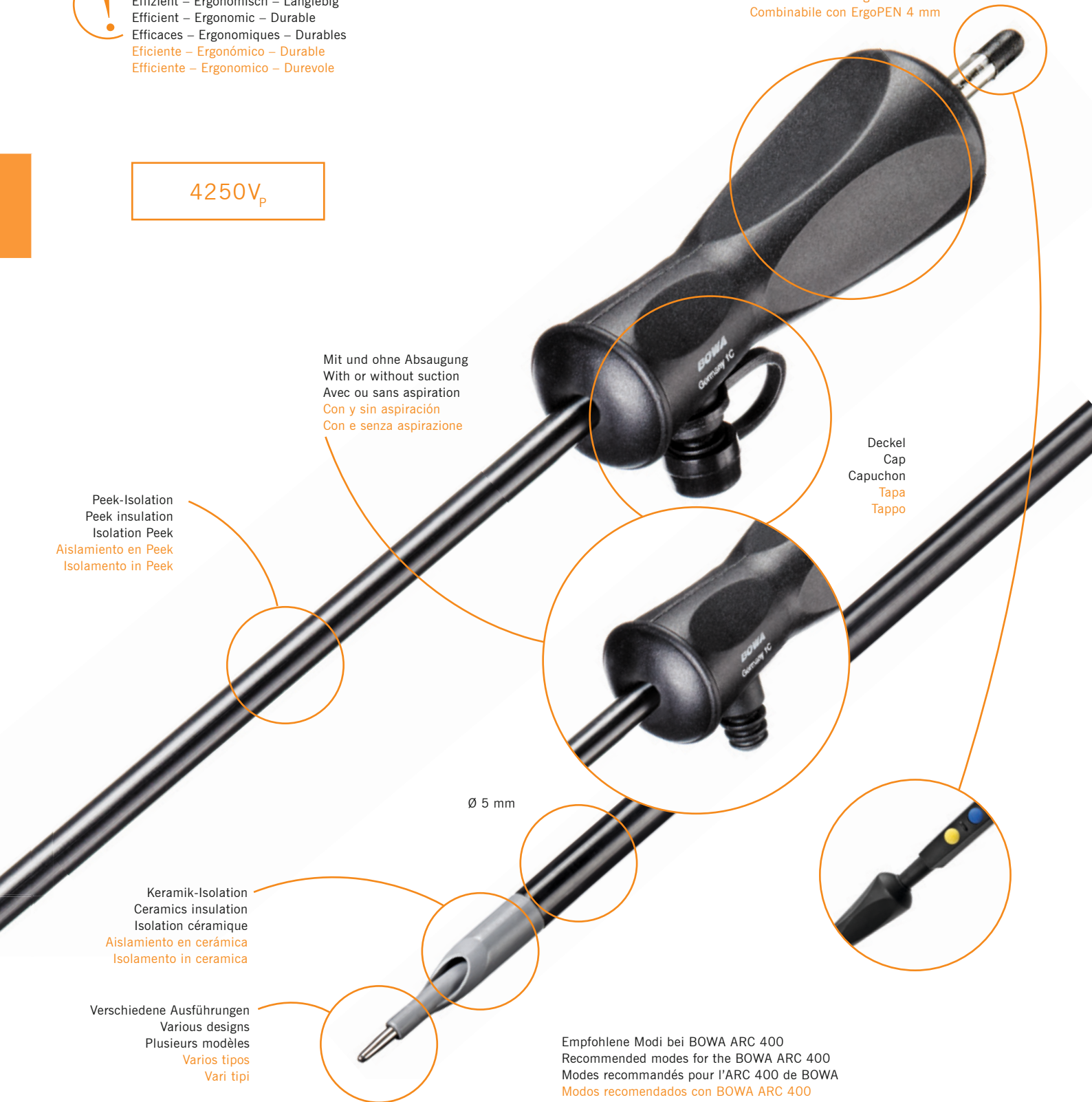

Mit und ohne Absaugung
 With or without suction
 Avec ou sans aspiration
 Con y sin aspiración
 Con e senza aspirazione

Peek-Isolation
 Peek insulation
 Isolation Peek
 Aislamiento en Peek
 Isolamento in Peek

Deckel
 Cap
 Capuchon
 Tapa
 Tappo

Ø 5 mm

Keramik-Isolation
 Ceramics insulation
 Isolation céramique
 Aislamiento en cerámica
 Isolamento in ceramica

Verschiedene Ausführungen
 Various designs
 Plusieurs modèles
 Varios tipos
 Vari tipi

Empfohlene Modi bei BOWA ARC 400
 Recommended modes for the BOWA ARC 400
 Modes recommandés pour l'ARC 400 de BOWA
 Modos recomendados con BOWA ARC 400
 Modalità consigliate per BOWA ARC 400



Laparoskopie CUT
 Laparoscopy CUT
 Laparoscopie CUT
 Laparoscopia CUT
 Laparoscopia CUT



Laparoskopie COAG
 Laparoscopy COAG
 Laparoscopie COAG
 Laparoscopia COAG
 Laparoscopia COAG

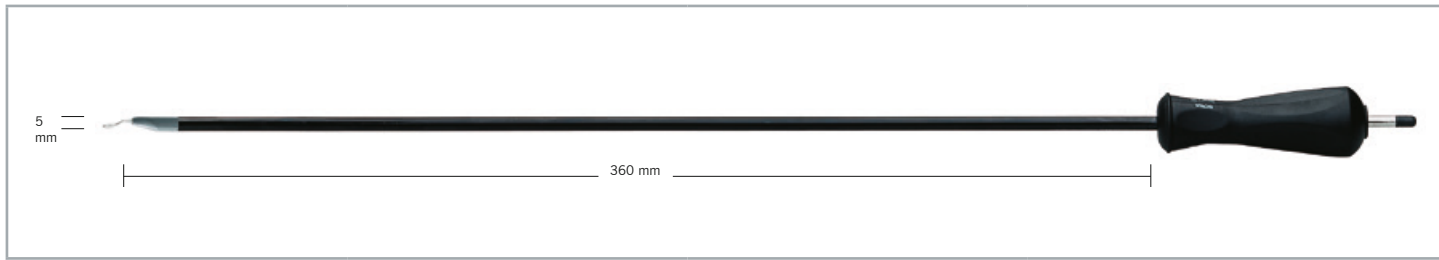

Ohne Absaugung
Without suction
Sans aspiration
Sin aspiración
Senza aspirazione

	<p>Spatelförmig Spatula Spatule Espátula A spatola</p>	<p>700-003</p>	
	<p>Verstärkter Haken "J" Strong hook "J" Crochet renforcé "J" Gancho reforzado "J" Rinforzato a "J"</p>	<p>700-004</p>	
	<p>Feiner Haken "L" Thin hook "L" Crochet fin "L" Gancho fino "L" Uncino sottile a "L"</p>	<p>700-005</p>	
	<p>Nadel Needle Aiguille Aguja Ago</p>	<p>700-006</p>	

3.2 Elektroden für die Laparoskopie
 Electrodes for laparoscopic surgery
 Electrodes pour la cœlioscopie
 Electrodo de laparoscopia
 Elettrodi per laparoscopia

134°C
 Autoclave
 273°F

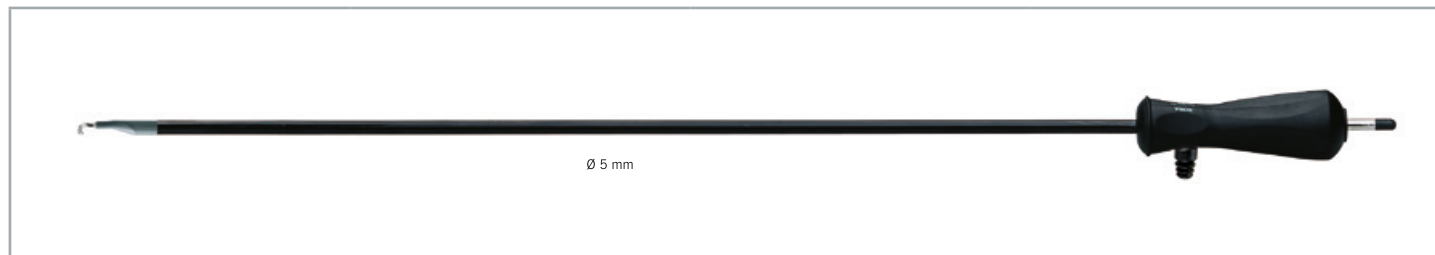

Mit Absaugung und Dichtkappe
 With suction and sealing cap
 Avec aspiration et bouchon hermétique
 Con aspiración y tapa
 Con aspirazione e tappo





	<p>Spatelförmig Spatula Spatule Espátula A spatola</p>	<p>710-003</p>	
	<p>Verstärkter Haken "J" Strong hook "J" Crochet renforcé "J" Gancho reforzado "J" Rinforzato a "J"</p>	<p>710-004</p>	
	<p>Feiner Haken "L" Thin hook "L" Crochet fin "L" Gancho fino "L" Uncino sottile a "L"</p>	<p>710-005</p>	
	<p>Nadel Needle Aiguille Aguja Ago</p>	<p>710-006</p>	

3.2 Zubehör
 Accessories
 Accessoires
 Accesorios
 Accessori









	<p>700-099</p>	<p>Dichtungskappe (5 Stck.) Sealing cap (5 pcs.) Capuchon d'étanchéité (5 pcs.) Tapón hermético (5 uds.) Guarnizione di tenuta (5 pz.)</p>
---	----------------	--



3.2 Anschlusskabel monopolar
 Connecting cables monopolar
 Câbles de raccordement monopolaires
 Cables de conexión monopolares
 Cavi di collegamento monopolari

Stecker, Geräteseite Plug, generator side Connecteur, côté générateur Enchufe, parte generador Spinotto, parte generatore	Stecker, Instrumentenseite Plug, instrument side Connecteur, côté instrument Enchufe, parte instrumento Spinotto, parte strumento	Passend für Gerätetyp Fitting generator type Pour générateurs type Para generadores tipo Per generatori tipo	REF
 <p>∅ 5 mm</p>		Erbe VIO / ICC / ACC	<p>101-060 (4.5 m)</p>
 <p>∅ 4 mm</p>	 <p>∅ 4 mm</p> <p>6-Kant Hexagon coding Hexagonal Esagonale</p>	4 mm Ø Buchse 4 mm Ø socket Fiche 4 mm Ø Casquillo 4 mm Ø Presa 4 mm Ø	<p>280-035 (4.5 m)</p>
 <p>∅ 8 mm</p>		BOWA ERBE International Martin International Valleylab Conmed	<p>370-050 (4.5 m)</p>









 <p>360 mm</p> <p>∅ 5 mm</p>	736-005	Handgriff, Schaftrohr und Ersatzdichtungen Handle, shaft tube and sealing spare parts Manche, conduit et joints de rechange Mango, vástago y juntas de recambio Manipolo, asta tubolare e guarnizioni da ricambio
	720-000	Handgriff mit Rasterung Handle with ratchet Manche avec crémaillère Mango con trinquete integrato Impugnatura con cremagliera integrata
722-530		
 <p>360 mm</p> <p>∅ 5 mm</p>		Schaftrohr Shaft tube Conduit Tubo Asta tubolare
	721-301	Maulteil für Faszange 2 x 4 Zähne Jaw for forceps 2 x 4 teeth Mâchoires de pince 2 x 4 dents Inserto pinza de agarre 2 x 4 dientes Branche della pinza 2 x 4 denti
	721-302	Maulteil für DeBakey Faszange, atraumatisch Jaw for DeBakey grasping forceps, atraumatic Mâchoires de pince, modèle DeBakey, atraumatique Inserto pinza de agarre, tipo DeBakey, atraumático Branche della pinza, tipo DeBakey atraumatica
	721-303	Maulteil für Babcock Faszange, atraumatisch Jaw for Babcock grasping forceps, atraumatic Mâchoires de pince, modèle Babcock, atraumatique Inserto pinza de agarre, tipo Babcock, atraumático Branche della pinza, tipo Babcock atraumatica





	<p>721-304</p>	<p>Maulteil für Schere nach Metzenbaum, gebogen Jaw for Metzenbaum scissors, curved Mâchoires ciseaux, modèle Metzenbaum, courbées Inserto tipo tijera Metzenbaum, acodado Branche delle forbici tipo Metzenbaum, curve</p>
	<p>721-306</p>	<p>Maulteil für Hakenschere Jaw for hook scissors Mâchoires ciseaux en forme de crochet Inserto tijera tipo de gancho Branche delle forbici, ad uncino</p>
	<p>721-307</p>	<p>Maulteil für Dorsey Fasszange Jaw for Dorsey grasping forceps Mâchoires de pince, modèle Dorsey Inserto pinza de agarre tipo Dorsey Branche della pinza, tipo Dorsey</p>
	<p>721-308</p>	<p>Maulteil für Fundus Fasszange Jaw for Fundus grasping forceps Mâchoires de pince, modèle Fundus Inserto pinza de agarre, tipo Fundus Branche della pinza, tipo Fundus</p>
	<p>721-309</p>	<p>Maulteil für Maryland Dissektor Jaw for Maryland dissector Mâchoires de pince, modèle dissecteur Maryland Inserto dissector Maryland Branche per dissettore Maryland</p>
	<p>721-310</p>	<p>Maulteil für Alligator Fasszange Jaw for Alligator grasping forceps Mâchoires de pince, modèle Alligator Inserto pinza de agarre tipo aligatör Branche della pinza, tipo Alligator</p>

3.3 Anschlusskabel für ErgoLAP monopolar
 Connecting cables for ErgoLAP monopolar
 Câbles de raccordement pour ErgoLAP monopolaires
 Cables de conexión para ErgoLAP monopolar
 Cavi per ErgoLAP monopolari



Stecker, Geräteseite Plug, generator side Connecteur, côté générateur Enchufe, parte generador Spinotto, parte generatore	Stecker, Instrumentenseite Plug, instrument side Connecteur, côté instrument Enchufe, parte instrumento Spinotto, parte strumento	Passend für Gerätetyp Fitting generator type Pour générateurs type Para generador tipo Per generatori tipo	REF
 <p>Ø 5 mm</p>		Erbe VIO / ICC / ACC	101-145 (4.5 m)
 <p>12.5 mm 8 mm 4 mm</p>		Martin	270-145 (4.5 m)
 <p>Ø 8 mm</p>	 <p>Ø 4 mm</p>	BOWA ERBE International Martin International Valleylab Conmed	360-145 (4.5 m)
 <p>Ø 4 mm</p>		4 mm Ø Buchse 4 mm Ø socket Fiche 4 mm Ø Casquillo 4 mm Ø Manicotto 4 mm Ø	480-145 (4.5 m)
 <p>31.75 mm</p>		BOWA COMFORT 	360-245 (4.5 m)

3.3 Zubehör
 Accessories
 Accessoires
 Accesorios
 Accessori

<p>Ersatzdichtungen Sealing spare parts Set de joints de rechange Anillos de estanqueidad, recambio Set di guarnizioni di ricambio</p>		<p>723-020</p>
		
<p>4 Reinigungsbürsten, LAP 4 Cleaning brushes, LAP 4 Brosses de nettoyage, LAP 4 Escobillas de limpieza, LAP 4 Spazzole per la pulitura, LAP Ø 3,4,6,9 x 500 mm</p>	<p>723-000</p>	



Komfortabel – Ergonomisch
 Comfortable – Ergonomic
 Aisé – Ergonomiques
 Cómodo – Ergonómico
 Confortevole – Ergonomico

300 / 530V_p



reddot design award
 winner 2001



Verschiedene Ausführungen
 Various designs
 Plusieurs modèles
 Varios tipos
 Vari tipi

Innenschaftrohr
 Inner shaft tube
 Conduit intérieur
 Tubo interior
 Asta tubolare interna

Empfohlene Modi bei BOWA ARC 400
 Recommended modes for the BOWA ARC 400
 Modes recommandés pour l'ARC 400 de BOWA
 Modos recomendados con BOWA ARC 400
 Modalità consigliate per BOWA ARC 400



Bipolar COAG









Bipolar CUT



	750-033	Handgriff, Außen- und Innenschaftrohr und Ersatzdichtungen Handle, outer and inner shaft tube and sealing spare parts Manche, conduit extérieur et intérieur et joints de rechange Mango, tubo exterior y interior y juntas de recambio Manipolo, asta tubolare e guarnizioni di ricambio	
	750-000	Handgriff Handle Manche Mango Impugnatura	
	755-033	Außenschaftrohr Outer shaft tube Conduit extérieur Tubo exterior Asta tubolare esterna	
	756-033	Innenschaftrohr Inner shaft tube Conduit intérieur Tubo interior Asta tubolare interna	
	751-033	Mauleinsatz nach „Hirsch“ Jaw insert „Hirsch“ Mâchoires, modèle „Hirsch“ Inserto pinza tipo „Hirsch“ Branche delle forbici, tipo „Hirsch“	300V _p
	752-033	Mauleinsatz nach „Kleppinger“ Jaw insert „Kleppinger“ Mâchoires, modèle „Kleppinger“ Inserto pinza tipo „Kleppinger“ Branche delle forbici, tipo „Kleppinger“	
	753-033	Mauleinsatz: Pinzette Jaw insert tweezers Mâchoires, modèle pince Inserto pinza Branche, tipo pinza	
	754-033	Mauleinsatz: Micropinzette Jaw insert micro-tweezers Mâchoires, modèle micropince Inserto micropinza Branche, tipo micropinza	
	760-033	Maulteil für NON-Stick CUT, messerförmig Jaws for NON-Stick CUT, knife-shaped Mâchoire NON-Stick CUT, couteau Inserto non-stick CUT, tipo cuchillo Inserto NON-Stick CUT, a lama	530V _p
	761-033	Maulteil für NON-Stick CUT, keilförmig Jaws for NON-Stick CUT, wedge shaped Mâchoire NON-Stick CUT, couteau cunéiforme Inserto non-stick CUT, cuneado Inserto NON-Stick CUT, a cuneo	



3.4 Anschlusskabel ErgoLAP bipolar
 Connecting cables ErgoLAP bipolar
 Câbles de raccordement pour ErgoLAP bipolaires
 Cables de conexión ErgoLAP bipolar
 Cavi di collegamento ErgoLAP bipolar

Stecker, Geräteseite Plug, generator side Connecteur, côté générateur Enchufe, parte generador Spinotto, parte generatore	Stecker, Instrumentenseite Plug, instrument side Connecteur, côté instrument Enchufe, parte instrumento Spinotto, parte strumento	REF	Passend für Gerätetyp Fitting generator type Pour générateurs type Para generadores tipo Per generatori tipo
		101-245 (4.5 m)	Erbe ACC / ICC Erbe T-Serie Erbe VIO*
		287-245 (4.5 m)	Martin
		351-245 (4.5 m)	BOWA Erbe VIO* Valleylab Conmed
		350-245 (4.5 m)*	Erbe VIO International*
		351-345 (4.5 m)	BOWA COMFORT

* Abhängig von jeweiliger Buchsenkonfiguration
 Depends on individual socket configuration
 Dépend de la configuration individuelle du connecteur
 Según la configuración de enchufes respectiva
 Dipende dalla configurazione individuale dell'uscita



3.4 Zubehör
 Accessories
 Accessoires
 Accesorios
 Accessori

<p>Ersatzdichtungen Sealing spare parts Set de joints de rechange Anillos de estanqueidad, recambio Set di guarnizioni di ricambio</p>		<p>750-010</p>
		
<p>4 Reinigungsbürsten, LAP 4 Cleaning brushes, LAP 4 Brosses de nettoyage, LAP 4 Escobillas de limpieza, LAP 4 Spazzole per la pulitura, LAP Ø 3,4,6,9 x 500 mm</p>	<p>723-000</p>	

3.5 ERGO BIPOLAR

Koagulationsinstrumente für die Laparoskopie in 5 und 3 mm
 Laparoscopic coagulation instruments, 5 mm & 3 mm
 Instruments de coagulation pour la laparoscopie en 5 et 3 mm
 Instrumentos de coagulación para laparoscopia en 5 y 3 mm
 Strumenti per la coagulazione per laparoscopia da 5 e 3 mm



Europäischer Flachstecker
 European flat plug
 Fiche plate européenne
 Enchufe plano europeo
 Connettore piatto europeo

3,4 mm Trokar
 3.4 mm trocar
 Trocart de 3,4 mm
 Trocar de 3,4 mm
 Trocar da 3,4 mm

Doppelgelenk für taktiles Feedback beim Öffnen und Schließen
 Double joint for tactile feedback when opening and closing
 Double joint pour retour tactile en ouverture et fermeture
 Doble junta para retroalimentación táctil al abrir y cerrar
 Doppia articolazione per feedback tattile in apertura e chiusura



Verschiedene Ausführungen
 Various designs
 Plusieurs modèles
 Varios tipos
 Vari tipi

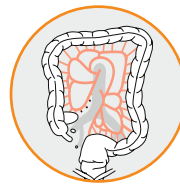

Allgemeinchirurgie
 General Surgery
 Chirurgie générale
 Cirugía general
 Chirurgia Generale

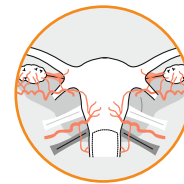

Gynäkologie
 Gynaecology
 Gynécologie
 Ginecología
 Ginecologia



Urologie
 Urology
 Urologie
 Urología
 Urologia

Empfohlene Modi bei BOWA ARC 400
 Recommended modes for the BOWA ARC 400
 Modes recommandés pour l'ARC 400 de BOWA
 Modos recomendados con BOWA ARC 400
 Modalità consigliate per BOWA ARC 400



LAP Coag











LAP micro

3.5 ERGO BIPOLAR

Koagulationsinstrumente Ø 5 mm 5 mm coagulation instruments Instruments de coagulation Ø 5 mm Instrumental de coagulación Ø 5 mm Strumenti per la coagulazione da Ø 5 mm



	Schaftrohr / Shaft / Conduit / Tubo / Camicia		Griffvarianten / Handle options / Variantes de manches / Versiones del mango / Varianti di impugnatura			REF
	340 mm 741-234	340 mm 742-234	 ERGO 320R COMFORT Handgriff, Kabel 4,5m Handle, 4.5m cable Manche, câble de 4,5m Mango, cable 4,5m Impugnatura, cavo 4,5m 741-100	 ERGO 320R Handgriff Handle Manche Mango Impugnatura 741-101	 ERGO 325R Handgriff, drehbar, mit Arretierung Rotating handle, with lock Manche, rotatif, avec blocage Mango, giratorio, con bloqueo Impugnatura, rotabile, con cremagliera 742-106	
 Maulteil Jaw insert Mors Mordaza Inserto						Komplettinstrument bestehend aus: Maulteil, Schaftrohr, Handgriff Complete instrument Consisting of: Jaw insert, shaft, handle Instrument complet Composé de : Mors, conduit, manche Instrumento completo compuesto por: Mordaza, tubo, mango Strumento completo composto da: Inserto, camicia, impugnatura
 Atraumatische Faszange, gefenstert Atraumatic forceps, fenestrated Pince de préhension atraumatique, fenêtrée Pinza de agarre atraumática, fenestrada Pinza da presa atraumatica, fenestrada 742-310	●		●			741-812
	●			●		741-814
		●			●	742-816
 Faszange, gefenstert, gebogen Forceps, fenestrated, curved Pince de préhension, fenêtrée, courbée Pinza de agarre fenestrada, curvada Pinza da presa, fenestrada, curva 742-320	●		●			741-822
	●			●		741-823
		●			●	742-826
 Metzenbaum Schere „Metzenbaum“ scissor Ciseaux de Metzenbaum Tijera Metzenbaum Forbici Metzenbaum 742-330	●		●			741-832
	●			●		741-833
		●			●	742-836
 Maryland Dissektor „Maryland“ dissector Dissecteur Maryland Disector Maryland Dissettore Maryland 742-340	●		●			741-842
	●			●		741-843
		●			●	742-846
 Faszange mit 2x3 Zähnen Forceps with 2x3 teeth Pince de préhension avec 2x3 dents Pinza de agarre con dentado 2x3 Pinza da presa con 2x3 denti 742-350	●		●			741-827
	●			●		741-828
		●			●	742-829

3.5 ERGO BIPOLAR

Koagulationsinstrumente Ø 3 mm 3 mm coagulation instruments Instruments de coagulation Ø 3 mm Instrumental de coagulación Ø 3 mm Strumenti per la coagulazione da Ø 3 mm



		Schaftrohr / Shaft / Conduit / Tubo / Camicia		Griffvarianten / Handle options / Variantes de manches / Versiones del mango / Varianti di impugnatura		REF
<p>Maulteil Jaw insert Mors Mordaza Inserto</p>						<p>Komplettinstrument bestehend aus: Maulteil, Schaftrohr, Handgriff Complete instrument Consisting of: Jaw insert, shaft, handle Instrument complet Composé de : Mors, conduit, manche Instrumento completo compuesto por: Mordaza, tubo, mango Strumento completo composto da: Inserto, camicia, impugnatura</p>
<p>Atraumatische Fasszange, gefenestert Atraumatic forceps, fenestrated Pince de préhension atraumatique, fenêtrée Pinza de agarre atraumática, fenestrada Pinza da presa atraumatica, fenestrata</p>		744-313	●	●	●	744-812
		744-312	●	●	●	744-815
		744-312	●	●	●	744-813
		744-312	●	●	●	744-816
<p>Maryland Dissektor „Maryland“ dissector Dissecteur Maryland Disector Maryland Dissettore Maryland</p>		744-343	●	●	●	744-844
		744-342	●	●	●	744-847
		744-342	●	●	●	744-845
		744-342	●	●	●	744-848

3.5 ERGO BIPOLAR

Zubehör Accessories Accessoires Accesorios Accessori



		L	Durchlass Aperture Passage libre Paso Passaggio	REF
	Trocarhülse mit Insufflationshahn Metallrohr, glatt, distal abgeschrägt Trocar sleeve with insufflation tap, metal tube, smooth, distal bevel Douille de trocar avec robinet d'insufflation tube métallique, lisse, biseautage distal Trocar con llave de insuflación Tubo metálico liso, con biselado distal Manicotto del trocar con rubinetto per insuflazione, tubo in metallo, liscio, distale smussato	100 mm	3.4 mm	745-100
	Trokar, Spitze dreikantig Trocar, triangular tip Trocart, pointe trigonale Trocar, punta triangular Trocar, punta a tre lati			745-200
	Silikonventil für Trocarhülse (5 Stk.) Silikon valve for trocar sleeve (5 pcs.) Valve en silicone pour douille de trocar (5 pcs.) Válvula de silicone para trocar (5 pzs.) Valvola di silicone per camicia per trocar (5 pz.)			745-120
	Dichtungskappe für Trocarhülse (5 Stk.) Sealing for trocar sleeve (5 pcs.) Bouchon pour douille de trocar (5 pcs.) Tapa de cierre para trocar (5 pzs.) Guarnizione per la camicia del trocar (5 pz.)			745-130

Geräteseitig / At the unit / Côté appareil / En el lado del aparato / Parte generatore				
	BOWA Erbe International* Martin International Valleylab Conmed	Erbe VIO / ICC / ACC Erbe T-Serie	Erbe VIO International*	Martin
Instrumentseitig / At the instrument / Côté instrument / Lado del instrumento / Parte strumento				
	BOWA-Pinzette Europäischer Flachstecker BOWA forceps European flat connector Pinze BOWA Fiche plate européenne Pinza BOWA conector plano europeo Pinze BOWA connettore piatto europeo	351-040 (4.5 m)	101-040 (4 m)	353-040 (4,5 m)
				287-040 (4.5 m)
		* Abhängig von der jeweiligen Buchsenkonfiguration * Depending on the respective socket configuration * Dépend de la configuration de prise respective		* Según la configuración de enchufes respectiva * In funzione della rispettiva configurazione della presa

3.6 ERGO 300 Morzellator
 Morcellator
 Morcellateur
 Morcelador
 Morcellatore

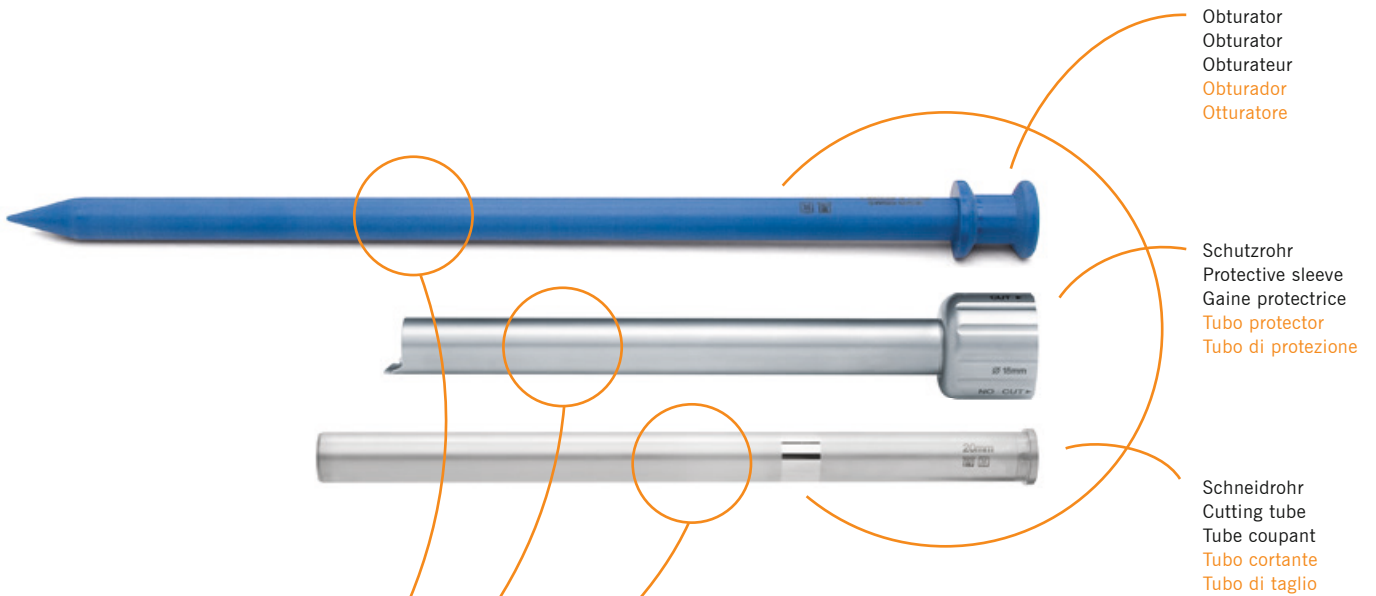

Mikromotor ERGO 300 mit Kabel 3 m
 Micromotor ERGO 300 with cable 3 m
 Micromoteur ERGO 300 avec câble 3 m
 Micromotor ERGO 300 con cable 3 m
 Micromotore ERGO 300, cavo 3 m

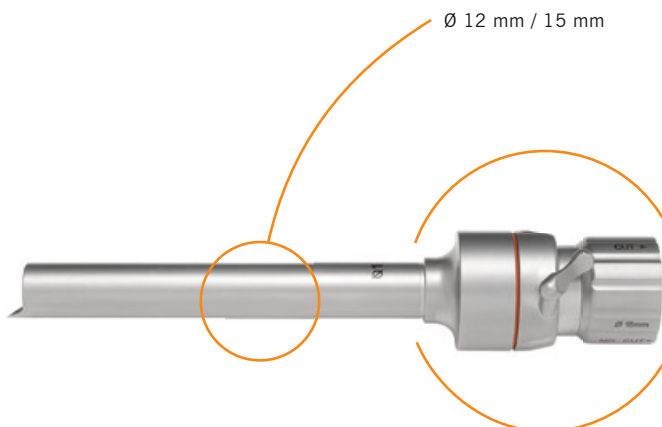

Trokarhülse
 Trocar sleeve
 Douille de trocar
 Casquillo de trocar
 Camicia per trocar

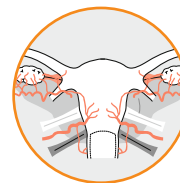

Gynäkologie
Gynaecology
Gynécologie
Ginecologia
Ginecologia

Vario-Fußschalter mit Kabel 3 m
Vario Foot switch with cable 3 m
Pédale Vario avec câble 3 m
Vario interruptor de pie con cable 3 m
Comando a pedale Vario, cavo 3 m









Steuergerät ERGO 300, Netzkabel 3 m
Control unit ERGO 300 including power cord 3 m
Unité de commande ERGO 300, câble d'alimentation 3 m
Unidad de control ERGO 300 con cable 3 m
Unità di controllo ERGO 300, cavo 3 m



3.6 ERGO 300 Morzellator
 Morcellator
 Morcellateur
 Morcelador
 Morcellatore

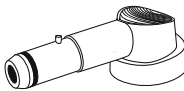

	<p>905-001</p>	<p>Steuergerät ERGO 300, Netzkabel 3 m Control unit ERGO 300 including power cord 3 m Unité de commande ERGO 300, câble d'alimentation 3 m Unidad de control ERGO 300 con cable 3 m Unità di controllo ERGO 300, cavo 3 m (TCM 3000 BL Morcellator)</p>
	<p>905-002</p>	<p>Mikromotor ERGO 300 mit Kabel 3 m Micromotor ERGO 300 with cable 3 m Micromoteur ERGO 300 avec câble 3 m Micromotor ERGO 300 con cable 3 m Micromotore ERGO 300, cavo 3 m</p>
	<p>905-003</p>	<p>Vario-Fußschalter mit Kabel 3 m Vario Foot switch with cable 3 m Pédale Vario avec câble 3 m Vario interruptor de pie con cable 3 m Comando a pedale Vario, cavo 3 m</p>
	<p>905-004</p>	<p>Getriebeeinheit komplett mit Dichtungen Gear unit complete including seals Système de transmission complet avec joints Unidad de transmisión completa, con juntas Unità di cambio completa di guarnizioni</p>
	<p>905-005</p>	<p>Handgriff Handle Poignée Mango Impugnatura</p>

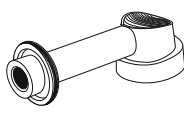

905-000 SET			
	905-001		905-004
			905-005
	905-002		905-006
	905-003		905-007

	905-612 Ø 12 mm	905-615 Ø 15 mm	905-620 Ø 20 mm	Anwendungsset Application set Kit d'application Set de aplicación Set applicazione
	905-112	905-115	905-120	Schneidrohr Cutting tube Tube coupant Tubo cortante Tubo di taglio
	905-012	905-015	905-020	Obturator Obturator Obturateur Obturador Otturatore
	905-212	905-215	905-220	Schutzrohr Protective sleeve Gaine protectrice Tubo protector Tubo di protezione





3.6 ERGO 300 Morzellator
 Morcellator
 Morcellateur
 Morcelador
 Morcellatore

134°C
 Autoclave
 273°F

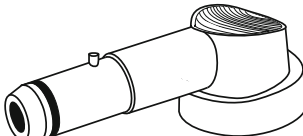
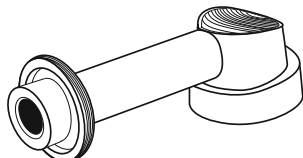

	Ø 12 mm	Ø 15 mm	Ø 20 mm	
	905-312	905-315	-	Trokarhülse Trocar sleeve Douille de trocar Casquillo de trocar Camicia per trocar

3.6 Zubehör
 Accessories
 Accessoires
 Accesorios
 Accessori

	905-412	Tenaculum Zange Ø 10 mm Tenaculum forceps Ø 10 mm Pince Tenaculum Ø 10 mm Pinza tenáculo Ø 10 mm Pinze Tenaculum Ø 10 mm
	905-415	Greifzange Ø 10 mm Claw grasper Ø 10 mm Pince de préhension Ø 10 mm Pinza de agarre Ø 10 mm Pinza da presa Ø 10 mm
	905-006	Spraydüse Getriebeeinheit Spray nozzle gear unit Pulvérisateur pour système de transmission Boquilla de spray para transmisor Unità di cambio, ugello spray
	905-007	Spraydüse Motor Spray nozzle motor Pulvérisateur pour micromoteur Boquilla de spray para motor Motore, ugello spray
	905-010	Myombohrer Ø 10 mm Myoma drill Ø 10 mm Tire-myome Ø 10 mm Taladro mioma Ø 10 mm Trapano per mioma Ø 10 mm
	905-424	Schaft Ø 10 mm Shaft Ø 10 mm Conduit Ø 10 mm Vástago Ø 10 mm Tubo Ø 10 mm



	<p>905-423</p>	<p>Maulteil Tenaculum Zange Ø 10 mm Jaw tenaculum forceps Ø 10 mm Insert Tenaculum Ø 10 mm Inserto pinza tenáculo Ø 10 mm Inserto pinze Tenaculum Ø 10 mm</p>
	<p>905-422</p>	<p>Maulteil Greifzange Ø 10 mm Jaw grasping forceps Ø 10 mm Insert de préhension Ø 10 mm Inserto pinza de agarre Ø 10 mm Inserto pinza da presa Ø 10 mm</p>
	<p>905-421</p>	<p>Handgriff mit zuschaltbarer Raste Handle with selectable latch Poignée à crémaillère enclenchable Mango con cremallera integrada y seleccionable Morcellatore con cremagliera selezionabile</p>
	<p>905-013</p>	<p>Morzellator Motorkabel 3 m Morcellator Motor cable 3 m Morcellateur Câble du moteur 3m Morcelador Cable para motor 3 m Morcellatore Cavo motore 3 m</p>
	<p>905-014</p>	<p>Morzellator Reinigungsspray "Nou Clean" Morcellator Cleaning spray "Nou Clean" Morcellateur Spray de nettoyage "Nou Clean" Morcelador Spray de limpieza "Nou Clean" Morcellatore Spray di Pulizia "Nou Clean"</p>
	<p>905-009</p>	<p>Morzellator Dichtung mit Einschnitt / 10 St. Morcellator Sealing with incision / 10 pc. Morcellateur Joint avec incision / 10 pc. Morcelador Tapa de estanquidad con incisión / 10 pz. Morcellatore Guarnizione con intaglio / 10 pz.</p>
	<p>905-512</p>	<p>Morzellator Dichtung Ø 12–20 mm / 10 St. Morcellator Seal Ø 12–20 mm / 10 pc. Morcellateur Joints d'étanchéité Ø 12–20 mm / 10 pc. Junta Morceladori Ø 12–20 mm / 10 pz. Morcellatore Guarnizioni Ø 12–20 mm / 10 pz.</p>
	<p>905-011</p>	<p>Morzellator Dichteinheit Morcellator Gasket holder Morcellateur Élément d'étanchéité Morcelador Unidad de juntas Morcellatore Unità di tenuta</p>
	<p>905-008</p>	<p>Morzellator Trägerplatte ERGO 300 Morcellator Carrier plate ERGO 300 Morcellateur Plateau de transport ERGO 300 Soporte para Morcelador ERGO 300 Morcellatore Supporto ERGO 300</p>

4 Pinzetten
 Forceps
 Pincas
 Pinzas
 Pinzette

4.1	NON-Stick-Gold Bipolare Antihaftpinzetten	4.1	NON-Stick-Gold Bipolar non-sticking forceps	4.1	NON-Stick-Gold Pincas bipolaires non-adhésives
4.2	Pinzetten bipolar	4.2	Forceps bipolar	4.2	Pincas bipolaires
4.3	Pinzetten monopolar mit Stecker	4.3	Forceps monopolar with connector	4.3	Pincas monopolaires avec connecteur
4.4	Pinzetten monopolar ohne Stecker	4.4	Forceps monopolar without connector	4.4	Pincas monopolaires sans connecteur
4.1	NON-Stick-Gold Pinzas bipolares no adhesivas	4.1	NON-Stick-Gold Pinze bipolari antiadesive		
4.2	Pinzas bipolares	4.2	Pinze bipolari		
4.3	Pinzas monopolares con conector	4.3	Pinze monopolari con connettore		
4.4	Pinzas monopolares sin conector	4.4	Pinze monopolari senza connettore		

<p>Alle wiederverwendbaren Instrumente werden im unsterilen Zustand angeliefert und können bei 134 °C / 20 min sterilisiert werden.</p> <p>Alle Einmalprodukte sind nicht für den mehrmaligen Gebrauch vorgesehen.</p> <p>Für die allgemeine Wischdesinfektion können handelsübliche Mittel verwendet werden.</p> <p>Für unsachgemäße Reinigung, Sterilisation und Anwendung kann seitens BOWA keine Haftung übernommen werden.</p> <p>Die Produkte tragen das CE Zeichen nach Richtlinie 93 / 42 / EWG</p>	<p>All reusable instruments are supplied in an unsterile state and can be sterilised at 134 °C for 20 min.</p> <p>All single-use products are not intended for multiple usage.</p> <p>Commercially available agents can be used for general wiping and disinfection.</p> <p>BOWA can accept no liability for improper cleaning, sterilisation and use.</p> <p>The products are certified according to 93 / 42 / EEC</p>	<p>Tous les instruments réutilisables sont livrés non stériles et peuvent être stérilisés à 134 °C / 20 min.</p> <p>Aucun produit à usage unique n'est destiné à être réutilisé.</p> <p>Des produits courants disponibles dans le commerce peuvent être utilisés pour un lavage désinfectant général.</p> <p>BOWA exclue toute responsabilité quant au nettoyage, à la stérilisation ou à l'utilisation non conformes ou inappropriés.</p> <p>Les produits sont certifiés selon la directive 93 / 42 / CEE</p>
---	---	--



Todos los instrumentos reutilizables se suministran en estado no estéril y deben ser esterilizados a 134 °C / 20 min.

Todos los productos desechables no son previstos para reutilización.

Para la desinfección superficial general pueden utilizarse productos comerciales corrientes.

BOWA no asume ningún tipo de responsabilidad por la limpieza, la esterilización y la utilización indebida.

Los productos están certificados según la norma 93 / 42 / CEE

Tutti gli strumenti riutilizzabili sono forniti non sterili e possono essere sterilizzati per 20 min a 134 °C.

Tutti i prodotti monouso sono destinati a non essere riutilizzati.

Per la pulizia e la disinfezione generale è possibile utilizzare i prodotti in commercio.

BOWA non si assume alcuna responsabilità per la pulizia, la sterilizzazione e l'uso non conforme.

I prodotti sono certificati in accordo con 93 / 42 / CEE

4.1 NON-Stick-Gold Bipolare Antihaftpinzetten
Bipolar non-sticking forceps
Pincers bipolaires non-adhésives
Pinzas bipolares no adhesivas
Pinze bipolari antiadesive



Wärmeableitung und Antihafte Funktion
Heat removal and non-stick function
Évacuation de la chaleur et fonction non-adhésif
Dispersión del calor y función antiadherente
Dissipazione del calore e funzione antiadesivo

550V_p



Spannungssicherheit bis 550 Vp
Voltage safety up to 550 Vp
Sécurité de tension jusqu'à 550 Vp
Seguridad de tensión hasta 550 Vp
Sicurezza da tensioni fino a 550 Vp

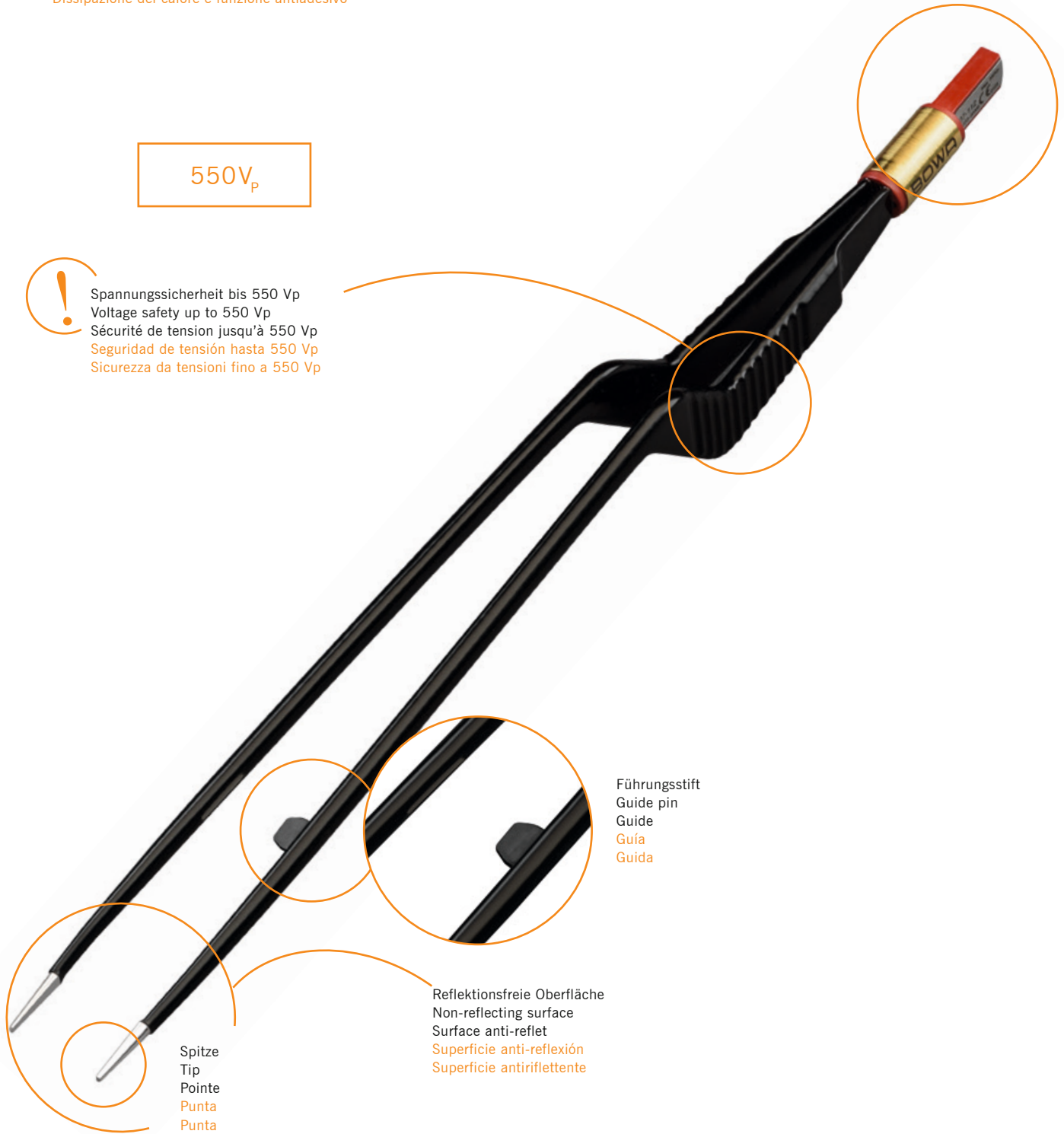

Führungsstift
Guide pin
Guide
Guía
Guida

Reflektionsfreie Oberfläche
Non-reflecting surface
Surface anti-reflet
Superficie anti-reflexión
Superficie antiriflettente

Spitze
Tip
Pointe
Punta
Punta

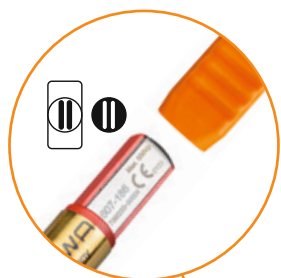

Entsprechende Anschlusskabel siehe Seite 93
 Corresponding connecting cables see page 93
 Câbles de raccordement correspondants voir page 93
 Cables de conexión correspondientes véase página 93
 Cavi di collegamento adatti vedi pagina 93

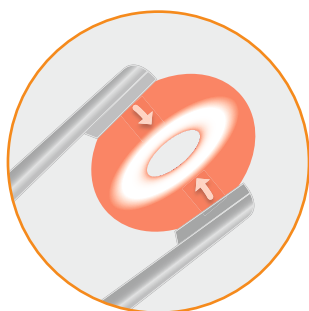

Blutstillung für Gefäße bis max. 2 mm
 Hemostasis of vessels up to 2 mm
 Hémostase de vaisseaux jusqu'à 2 mm
 Hemostasia de vasos hasta 2 mm
 Emostasi fino a 2 millimetri

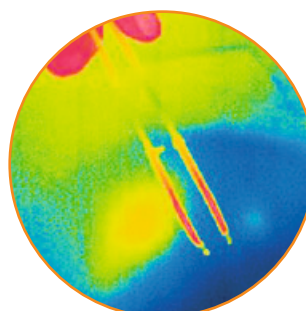

Atraumatische Spitze
 Atraumatic tip
 Pointe atraumatique
 Punta atraumática
 Punta atraumatica



Gewinkelte Spitze
 Angled tip
 Pointe coudée
 Punta acodada
 Punta angolata

Empfohlene Modi bei BOWA ARC 400
 Recommended modes for the BOWA ARC 400
 Modes recommandés pour l'ARC 400 de BOWA
 Modos recomendados con BOWA ARC 400
 Modalità consigliate per BOWA ARC 400



Micro





Pinzette
 Forceps
 Pince
 Pinza
 Pinza

4.1 NON-Stick-Gold Bipolare Antihaftpinzetten
 Bipolar non-sticking forceps
 Pincers bipolaires non-adhésives
 Pinzas bipolares no adhesivas
 Pinze bipolari antiadesive



Form / Shape / Forme / Forma / Forma	L			REF
Gerade Straight Droite Recta Retta	110 mm	6 mm	0,5 mm	607-020
	160 mm	8 mm	1 mm	607-039
	195 mm	8 mm	1 mm	607-040
	160 mm	8 mm	2 mm	607-027
	195 mm	8 mm	2 mm	607-029
	220 mm	8 mm	2 mm	607-030
	270 mm	8 mm	2 mm	607-080
Abgewinkelt Angled Coudée Acodada Angolata	110 mm	6 mm	0,5 mm	607-021
	160 mm	6 mm	1 mm	607-014
	195 mm	8 mm	1 mm	607-001
	195 mm	8 mm	2 mm	607-007
Bajonett Bayonet Baionnette Tipo bayoneta Baionetta	195 mm	6 mm	1 mm	607-002



Form / Shape / Forme / Forma / Forma	L			REF
Gerade Straight Droite Recta Retta	110 mm	6 mm	0.5 mm	607-020



Form / Shape / Forme / Forma / Forma	L			REF
Gerade Straight Droite Recta Retta	160 mm	8 mm	1 mm	607-039
	195 mm	8 mm	1 mm	607-040
	160 mm	8 mm	2 mm	607-027
	195 mm	8 mm	2 mm	607-029
	220 mm	8 mm	2 mm	607-030
	270 mm	8 mm	2 mm	607-080

4.1 NON-Stick-Gold Bipolare Antihaftpinzetten
 Bipolar non-sticking forceps
 Pinces bipolaires non-adhésives
 Pinzas bipolares no adhesivas
 Pinze bipolari antiadesive

134°C
 Autoclave
 273°F



Form / Shape / Forme / Forma / Forma	L			REF
Abgewinkelt Angled Coudée Acodada Angolata	110 mm	6 mm	0.5 mm	607-021





Form / Shape / Forme / Forma / Forma	L			REF
Abgewinkelt Angled Coudée Acodada Angolata	160 mm	6 mm	1 mm	607-014
	195 mm	8 mm	1 mm	607-001
	195 mm	8 mm	2 mm	607-007



Form / Shape / Forme / Forma / Forma	L			REF
Bajonett Bayonet Baïonnette Tipo bayoneta Baionetta	195 mm	6 mm	1 mm	607-002



Form / Shape / Forme / Forma / Forma	L			REF
Gerade Straight Droite Recta Retta	220 mm	9 mm	0,3 mm	607-130
Bajonett Bayonet Baïonnette Tipo bayoneta Baionetta	160 mm	9 mm	0,3 mm	607-100
	180 mm	9 mm	0,3 mm	607-101
	200 mm	9 mm	0,3 mm	607-102
	220 mm	9 mm	0,3 mm	607-103
	160 mm	9 mm	0,6 mm	607-105
	180 mm	9 mm	0,6 mm	607-106
	200 mm	9 mm	0,6 mm	607-107
	220 mm	9 mm	0,6 mm	607-108
	180 mm	9 mm	1 mm	607-110
	200 mm	9 mm	1 mm	607-111
	220 mm	9 mm	1 mm	607-112
	240 mm	9 mm	1 mm	607-113
	200 mm	9 mm	2 mm	607-115
	220 mm	9 mm	2 mm	607-116
	Bajonett, aufwärts gewinkelt Bayonet, angled up Baïonnette, Coudée vers le haut Bayoneta, acodadas hacia arriba A baionetta, angolata verso il basso	200 mm	9 mm	1 mm
220 mm		9 mm	1 mm	607-121
200 mm		9 mm	1 mm	607-122
220 mm		9 mm	1 mm	607-123

4.1 NON-Stick-Gold Bipolare Antihaftpinzetten
 Bipolar non-sticking forceps
 Pincès bipolaires non-adhésives
 Pinzas bipolares no adhesivas
 Pinze bipolari antiadesive

134°C
 Autoclave
 273°F



Form / Shape / Forme / Forma / Forma	L			REF
Gerade Straight Droite Recta Retta	220 mm	9 mm	0,3 mm	607-130



Form / Shape / Forme / Forma / Forma	L			REF
Bajonett Bayonet Baïonnette Tipo bayoneta Baionetta	160 mm	9 mm	0,3 mm	607-100
	180 mm	9 mm	0,3 mm	607-101
	200 mm	9 mm	0,3 mm	607-102
	220 mm	9 mm	0,3 mm	607-103

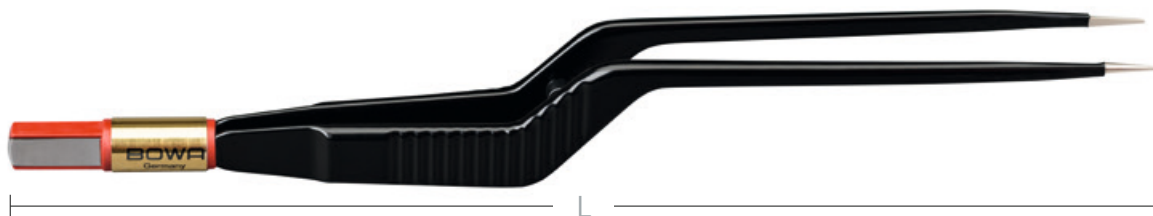

Form / Shape / Forme / Forma / Forma	L			REF
Bajonett Bayonet Baïonnette Tipo bayoneta Baionetta	160 mm	9 mm	0,6 mm	607-105
	180 mm	9 mm	0,6 mm	607-106
	200 mm	9 mm	0,6 mm	607-107
	220 mm	9 mm	0,6 mm	607-108





Form / Shape / Forme / Forma / Forma	L			REF
Bajonett Bayonet Baïonnette Tipo bayoneta Baionetta	180 mm	9 mm	1 mm	607-110
	200 mm	9 mm	1 mm	607-111
	220 mm	9 mm	1 mm	607-112
	240 mm	9 mm	1 mm	607-113
	200 mm	9 mm	2 mm	607-115
	220 mm	9 mm	2 mm	607-116

4.1 NON-Stick-Gold Bipolare Antihaftpinzetten
 Bipolar non-sticking forceps
 Pincès bipolaires non-adhésives
 Pinzas bipolares no adhesivas
 Pinze bipolari antiadesive

134°C
 Autoclave
 273°F



Form / Shape / Forme / Forma / Forma	L			REF
Bajonett, aufwärts gewinkelt Bayonet, angled up Baïonnette, Coudée vers le haut Bayoneta, acodadas hacia arriba A baionetta, angolata verso il basso	200 mm	9 mm	1 mm	607-120
	220 mm	9 mm	1 mm	607-121
	200 mm	9 mm	1 mm	607-122
	220 mm	9 mm	1 mm	607-123

4.1 NON-Stick-Gold Pinzetten mit Rundgriffdesign
 Forceps with rounded grip
 Pincas avec design de manche rond
 Pinzas con diseño de mango redondeado
 Pinze con design a impugnatura arrotondata



Form / Shape / Forme / Forma / Forma	L			REF
Gerade Straight Droite Recta Retta	155 mm	9 mm	0,3 mm	607-170
	180 mm	9 mm	0,3 mm	607-171
	155 mm	9 mm	0,6 mm	607-175
	180 mm	9 mm	0,6 mm	607-176
	200 mm	9 mm	0,6 mm	607-177
	180 mm	9 mm	1 mm	607-180
	200 mm	9 mm	1 mm	607-181
	225 mm	9 mm	1 mm	607-182
	200 mm	9 mm	2 mm	607-185
	225 mm	9 mm	2 mm	607-186
Abgewinkelt Angled Coudée Acodada Angolata	225 mm	9 mm	1 mm	607-190
Bajonett Bayonet Baïonnette Tipo bayoneta Baionetta	180 mm	9 mm	0,3 mm	607-140
	200 mm	9 mm	0,3 mm	607-141
	180 mm	9 mm	0,6 mm	607-145
	200 mm	9 mm	0,6 mm	607-146
	225 mm	9 mm	0,6 mm	607-147
	180 mm	9 mm	1 mm	607-150
	200 mm	9 mm	1 mm	607-151
	225 mm	9 mm	1 mm	607-152
	250 mm	9 mm	1 mm	607-153

4.1 NON-Stick-Gold Pinzetten mit Rundgriffdesign
 Forceps with rounded grip
 Pincès avec design de manche rond
 Pinzas con diseño de mango redondeado
 Pinze con design a impugnatura arrotondata

134°C
 Autoclave
 273°F



Form / Shape / Forme / Forma / Forma	L			REF
Gerade Straight Droite Recta Retta	155 mm	9 mm	0,3 mm	607-170
	180 mm	9 mm	0,3 mm	607-171



Form / Shape / Forme / Forma / Forma	L			REF
Gerade Straight Droite Recta Retta	155 mm	9 mm	0,6 mm	607-175
	180 mm	9 mm	0,6 mm	607-176
	200 mm	9 mm	0,6 mm	607-177



Form / Shape / Forme / Forma / Forma	L			REF
Gerade Straight Droite Recta Retta	180 mm	9 mm	1 mm	607-180
	200 mm	9 mm	1 mm	607-181
	225 mm	9 mm	1 mm	607-182
	200 mm	9 mm	2 mm	607-185
	225 mm	9 mm	2 mm	607-186



Form / Shape / Forme / Forma / Forma	L			REF
Abgewinkelt Angled Coudée Acodada Angolata	225 mm	9 mm	1 mm	607-190

4.1 NON-Stick-Gold Pinzetten mit Rundgriffdesign
 Forceps with rounded grip
 Pincès avec design de manche rond
 Pinzas con diseño de mango redondeado
 Pinze con design a impugnatura arrotondata

134°C
 Autoclave
 273°F



Form / Shape / Forme / Forma / Forma	L			REF
Bajonett Bayonet Baïonnette Tipo bayoneta Baionetta	180 mm	9 mm	0,3 mm	607-140
	200 mm	9 mm	0,3 mm	607-141



Form / Shape / Forme / Forma / Forma	L			REF
Bajonett Bayonet Baïonnette Tipo bayoneta Baionetta	180 mm	9 mm	0,6 mm	607-145
	200 mm	9 mm	0,6 mm	607-146
	225 mm	9 mm	0,6 mm	607-147

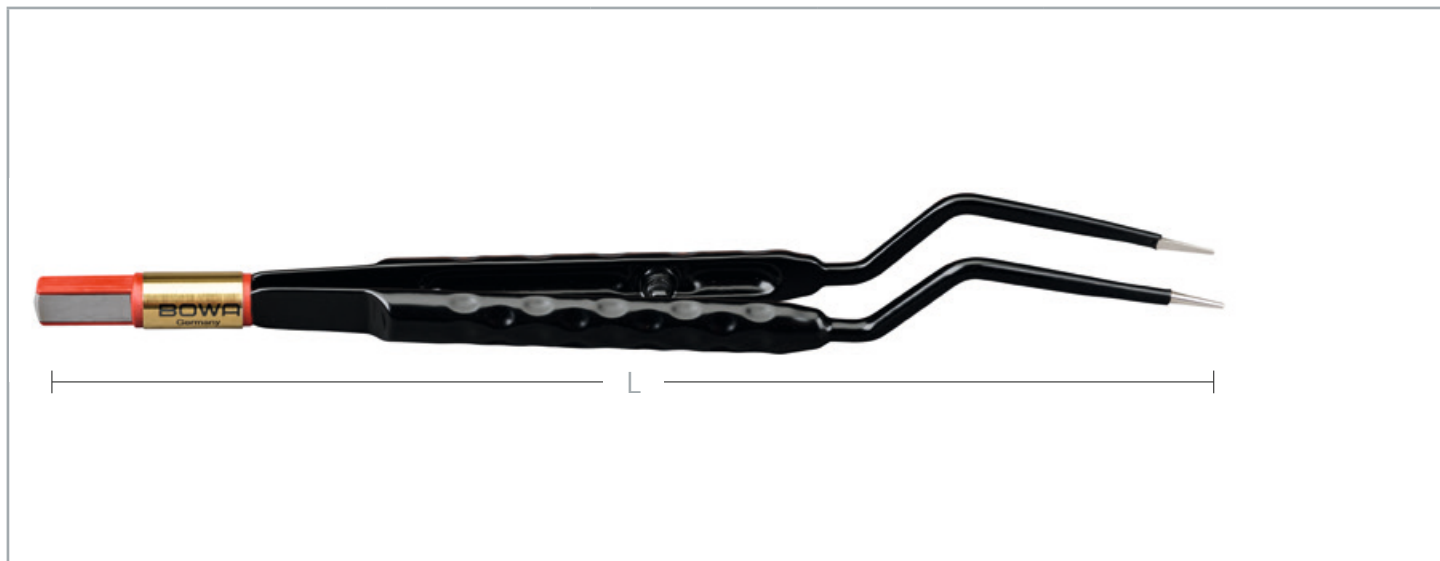



Form / Shape / Forme / Forma / Forma	L			REF
Bajonett Bayonet Baïonnette Tipo bayoneta Baionetta	180 mm	9 mm	1 mm	607-150
	200 mm	9 mm	1 mm	607-151
	225 mm	9 mm	1 mm	607-152
	250 mm	9 mm	1 mm	607-153

4.2 Pinzetten bipolar
 Forceps bipolar
 Pincas bipolaires
 Pinzas bipolares
 Pinze bipolari



Form / Shape / Forme / Forma / Forma	L			REF
Gerade Straight Droite Recta Retta	110 mm	6 mm	● needle tip	605-019
	110 mm	6 mm	0.5 mm	605-020
	160 mm	6 mm	● needle tip	605-011
	160 mm	8 mm	1 mm	605-039
	160 mm	8 mm	2 mm	605-027
	195 mm	8 mm	1 mm	605-040
	195 mm	8 mm	2 mm	605-029
Gerade, Karo Riffelung Straight, checker profile Droite, profil carré Recta, perfil cuadrado Retta, profilo a quadretti	195 mm	8 mm	2 mm	605-057
Gerade Straight Droite Recta Retta	220 mm	8 mm	1 mm	605-041
	220 mm	8 mm	2 mm	605-030
	270 mm	8 mm	2 mm	605-080
	300 mm	8 mm	2 mm	605-070
Abgewinkelt Angled Coudée Acodada Angolata	110 mm	6 mm	● needle tip	605-023
	110 mm	6 mm	0.5 mm	605-021
	160 mm	6 mm	● needle tip	605-036
	160 mm	6 mm	0.5 mm	605-013
	160 mm	6 mm	1 mm	605-014
	195 mm	8 mm	1 mm	605-001
	195 mm	8 mm	2 mm	605-007



Form / Shape / Forme / Forma / Forma	L			REF
Abgewinkelt, Karo Riffelung Angled, checker profile Coudée, profil carré Acodada, perfil cuadrado Angolato, profilo a quadretti	195 mm	8 mm	2 mm	605-058
Abgewinkelt Angled Coudée Acodada Angolata	220 mm	8 mm	1 mm	605-024
Bajonett Bayonet Baionnette Tipo bayoneta Baionetta	165 mm	6 mm	0.5 mm	605-033
	165 mm	6 mm	1 mm	605-018
	195 mm	6 mm	1 mm	605-002
	195 mm	8 mm	2 mm	605-034
Bajonett, Karo Riffelung Bayonet, checker profile Baionnette, profil carré Tipo bayoneta, perfil cuadrado Baionetta, profilo a quadretti	195 mm	8 mm	2 mm	605-059
Bajonett Bayonet Baionnette Tipo bayoneta Baionetta	220 mm	6 mm	0.5 mm	605-031
Bajonett, abgewinkelt Bayonet, angled Baionnette, coudée Tipo bayoneta, acodada Baionetta, angolata	220 mm	6 mm	1 mm	605-063

4.2 Pinzetten bipolar
 Forceps bipolar
 Pincès bipolaires
 Pinzas bipolares
 Pinze bipolari

134°C
 Autoclave
 273°F



Form / Shape / Forme / Forma / Forma	L			REF
Gerade Straight Droite Recta Retta	110 mm	6 mm	● needle tip	605-019
	110 mm	6 mm	0.5 mm	605-020



Form / Shape / Forme / Forma / Forma	L			REF
Gerade Straight Droite Recta Retta	160 mm	6 mm	● needle tip	605-011
	160 mm	8 mm	1 mm	605-039
	160 mm	8 mm	2 mm	605-027
	195 mm	8 mm	1 mm	605-040
	195 mm	8 mm	2 mm	605-029
Gerade, Karo Riffelung Straight, checker profile Droite, profil carré Recta, perfil cuadrado Retta, profilo a quadretti	195 mm	8 mm	2 mm	605-057
Gerade Straight Droite Recta Retta	220 mm	8 mm	1 mm	605-041
	220 mm	8 mm	2 mm	605-030
	270 mm	8 mm	2 mm	605-080
	300 mm	8 mm	2 mm	605-070

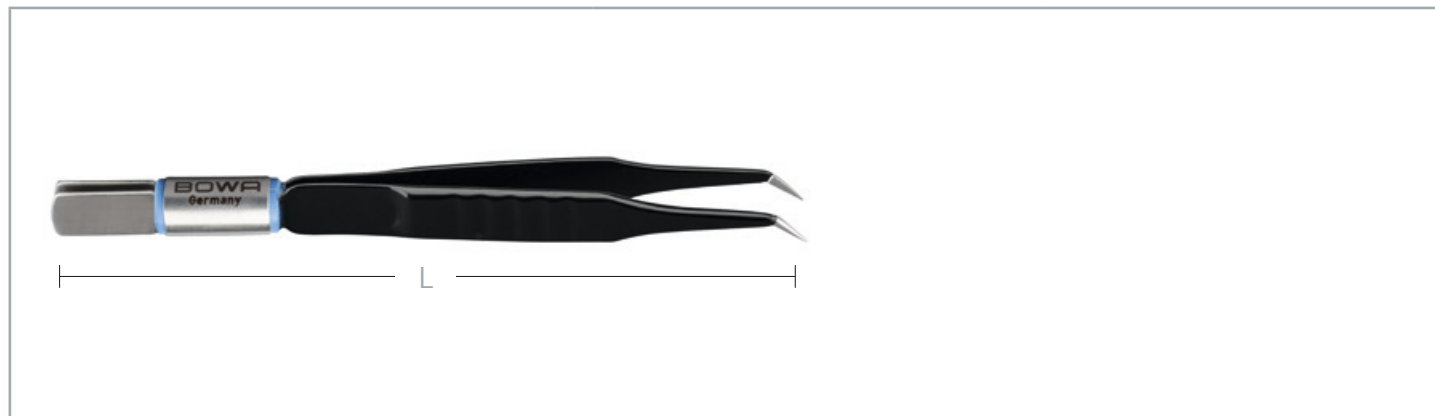

Form / Shape / Forme / Forma / Forma	L			REF
Abgewinkelt Angled Coudée Acodada Angolata	110 mm	6 mm	● needle tip	605-023
	110 mm	6 mm	0.5 mm	605-021





Form / Shape / Forme / Forma / Forma	L			REF
Abgewinkelt Angled Coudée Acodada Angolata	160 mm	6 mm	● needle tip	605-036
	160 mm	6 mm	0.5 mm	605-013
	160 mm	6 mm	1 mm	605-014
	195 mm	8 mm	1 mm	605-001
	195 mm	8 mm	2 mm	605-007
Abgewinkelt, Karo Riffelung Angled, checker profile Coudée, profil carré Acodada, perfil cuadrado Angolato, profilo a quadretti	195 mm	8 mm	2 mm	605-058
Abgewinkelt Angled Coudée Acodada Angolata	220 mm	8 mm	1 mm	605-024



4.2 Pinzetten bipolar
 Forceps bipolar
 Pincers bipolaires
 Pinzas bipolares
 Pinze bipolari

134°C
 Autoclave
 273°F



Form / Shape / Forme / Forma / Forma	L			REF
Bajonett Bayonet Baïonnette Tipo bayoneta Baionetta	165 mm	6 mm	0.5 mm	605-033
	165 mm	6 mm	1 mm	605-018
	195 mm	6 mm	1 mm	605-002
	195 mm	8 mm	2 mm	605-034
Bajonett, Karo Riffelung Bayonet, checker profile Baïonnette, profil carré Tipo bayoneta, perfil cuadrado Baionetta, profilo a quadretti	195 mm	8 mm	2 mm	605-059
Bajonett Bayonet Baïonnette Tipo bayoneta Baionetta	220 mm	6 mm	0.5 mm	605-031



Form / Shape / Forme / Forma / Forma	L			REF
Bajonett, abgewinkelt Bayonet, angled Baïonnette, coudée Tipo bayoneta, acodada Baionetta, angolata	220 mm	6 mm	1 mm	605-063

Geräteseitig / At the unit / Côté appareil / En el lado del aparato / Parte generatore					
COMFORT	BOWA Erbe International* Martin International Valleylab Conmed	Erbe VIO / ICC / ACC Erbe T-Serie	Erbe VIO International*	Martin	
	101-140 (4.5 m)	351-040 (4.5 m)	101-040 (4.0 m)	353-040 (4.5 m)	287-040 (4.5 m)
* Abhängig von der jeweiligen Buchsenkonfiguration * Depending on the respective socket configuration * Dépend de la configuration de prise respective			* Según la configuración de enchufes respectiva * In funzione della rispettiva configurazione della presa		

4.3 Pinzetten monopolar mit Stecker
Forceps monopolar with connector
Pincès monopolaires avec connecteur
Pinzas monopolares con conector
Pinze monopolari con conettore

134°C
Autoclave
273°F



Sicher – Schützt vor Verbrennungen
Safe – Protection against burns
Sûr – Protège contre les brûlures
Seguro – Protege de quemaduras
Sicuro – Protegge contro ustioni

3500V_p

Reflektionsfreie Oberfläche
Non-reflecting surface
Surface anti-reflet
Superficie anti-reflexión
Superficie antiriflettente

Mit Stecker
With connector
Avec connecteur
Con conector
Con conettore

Anatomische Spitze
Anatomic tip
Pointe anatomique
Punta anatómica
Punta anatomica

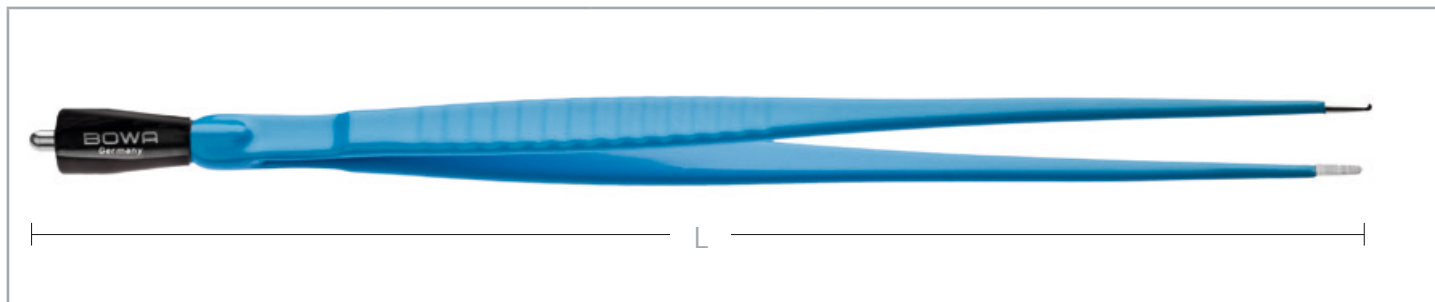

Form / Shape / Forme / Forma / Forma	L			REF
Quer Riffelung Cross-striped profile Profil à rayures horizontales Perfil rayado horizontal Scanalatura trasversale	195 mm	8 mm	1 mm	610-018
	195 mm	8 mm	2 mm	610-017
	220 mm	8 mm	1 mm	610-021
	220 mm	8 mm	2 mm	610-019
	270 mm	8 mm	2 mm	610-025

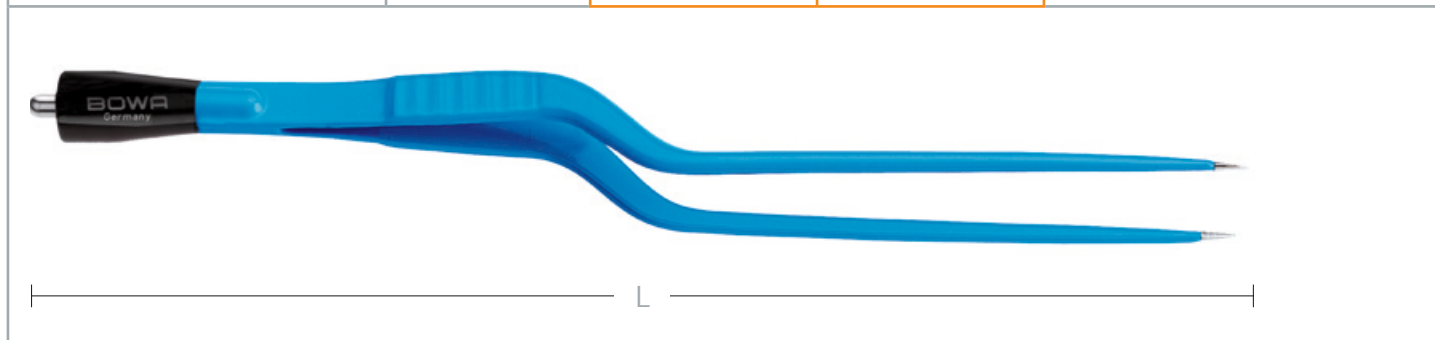

Form / Shape / Forme / Forma / Forma	L			REF
Bajonett, Quer Riffelung Bayonet, cross-striped profile Baïonnette, profil à rayures horizontales Tipo bayoneta, perfil rayado horizontal Baionetta, scanalatura trasversale	195 mm	8 mm	2 mm	610-016

Geräteseitig / At the unit / Côté appareil / En el lado del aparato / Parte generatore

Erbe VIO / ICC / ACC	4 mm Ø Buchse 4 mm Ø socket Fiche 4 mm Ø Casquillo 4 mm Ø Presa 4 mm Ø	Erbe international Martin International

Instrumentenseitig At the instrument Côté instrument Lado del instrumento Parte strumento		101-051 (4.5 m)	280-050 (4.5 m)	360-050 (4.5 m)

4.4 Pinzetten monopolar ohne Stecker
Forceps monopolar without connector
Pincés monopolaires sans connecteur
Pinzas monopolares sin conector
Pinze monopolari senza connettore

134°C
Autoclave
273°F



Sicher – Schützt vor Verbrennungen
Safe – Protection against burns
Sûr – Protège contre les brûlures
Seguro – Protege de quemaduras
Sicuro – Protegge contro ustioni

Ohne Stecker
Without connector
Sans connecteur
Sin conector
Senza connettore

3500V_p

Reflektionsfreie Oberfläche
Non-reflecting surface
Surface anti-reflet
Superficie anti-reflexión
Superficie antiriflettente

Chirurgische Spitze
Surgical tip
Pointe chirurgicale
Punta quirúrgica
Punta chirurgica

Anatomische Spitze
Anatomic tip
Pointe anatomique
Punta anatómica
Punta anatomica

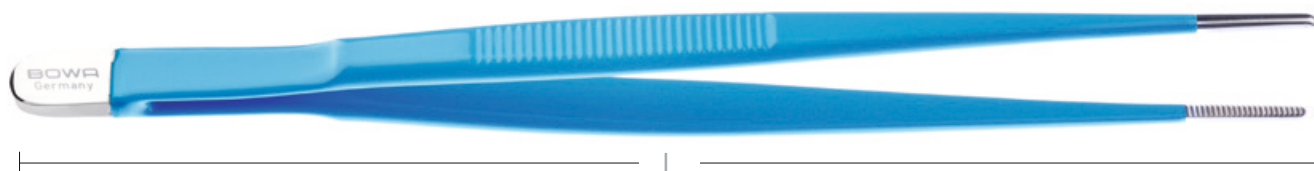

Form / Shape / Forme / Forma / Forma	L			REF
Anatomisch	180 mm	18 mm	2.0 mm	612-018
Anatomic	200 mm	18 mm	2.2 mm	612-021
Anatomique	250 mm	18 mm	2.4 mm	612-025
Anatómica				
Anatomica				



Form / Shape / Forme / Forma / Forma	L			REF
Chirurgisch	180 mm	18 mm	2.0 mm	612-118
Surgical	200 mm	18 mm	2.2 mm	612-121
Chirurgical	250 mm	18 mm	2.4 mm	612-125
Quirúrgica				
Chirurgica				

5 **BiZZER®** Bipolare Schere
 Bipolar scissors
 Ciseaux bipolaires
 Tijeras bipolares
 Forbici bipolari

5 BiZZER® Bipolare Schere	5 BiZZER® Bipolar scissors	5 BiZZER® Ciseaux bipolaires
5 BiZZER® Tijeras bipolares		5 BiZZER® Forbici bipolari

<p>Alle wiederverwendbaren Instrumente werden im unsterilen Zustand angeliefert und können bei 134 °C / 20 min sterilisiert werden.</p> <p>Alle Einmalprodukte sind nicht für den mehrmaligen Gebrauch vorgesehen.</p> <p>Für die allgemeine Wischdesinfektion können handelsübliche Mittel verwendet werden.</p> <p>Für unsachgemäße Reinigung, Sterilisation und Anwendung kann seitens BOWA keine Haftung übernommen werden.</p> <p>Die Produkte tragen das CE Zeichen nach Richtlinie 93 / 42 / EWG</p>	<p>All reusable instruments are supplied in an unsterile state and can be sterilised at 134 °C for 20 min.</p> <p>All single-use products are not intended for multiple usage.</p> <p>Commercially available agents can be used for general wiping and disinfection.</p> <p>BOWA can accept no liability for improper cleaning, sterilisation and use.</p> <p>The products are certified according to 93 / 42 / EEC</p>	<p>Tous les instruments réutilisables sont livrés non stériles et peuvent être stérilisés à 134 °C / 20 min.</p> <p>Aucun produit à usage unique n'est destiné à être réutilisé.</p> <p>Des produits courants disponibles dans le commerce peuvent être utilisés pour un lavage désinfectant général.</p> <p>BOWA exclue toute responsabilité quant au nettoyage, à la stérilisation ou à l'utilisation non conformes ou inappropriés.</p> <p>Les produits sont certifiés selon la directive 93 / 42 / CEE</p>
---	---	--



Todos los instrumentos reutilizables se suministran en estado no estéril y deben ser esterilizados a 134 °C / 20 min.

Todos los productos desechables no son previstos para reutilización.

Para la desinfección superficial general pueden utilizarse productos comerciales corrientes.

BOWA no asume ningún tipo de responsabilidad por la limpieza, la esterilización y la utilización indebida.

Los productos están certificados según la norma 93 / 42 / CEE

Tutti gli strumenti riutilizzabili sono forniti non sterili e possono essere sterilizzati per 20 min a 134 °C.

Tutti i prodotti monouso sono destinati a non essere riutilizzati.

Per la pulizia e la disinfezione generale è possibile utilizzare i prodotti in commercio.

BOWA non si assume alcuna responsabilità per la pulizia, la sterilizzazione e l'uso non conforme.

I prodotti sono certificati in accordo con 93 / 42 / CEE

BiZZER® Bipolare Schere
 Bipolar scissors
 Ciseaux bipolaires
 Tijeras bipolares
 Forbici bipolari



Verbesserte ergonomische Handhabung
 Improved ergonomic handling
 Manipulation ergonomique améliorée
 Manejo ergonómico mejorado
 Maneggevolezza ed ergonomia migliorate

200 V_p

Universell konnektierbar
 Universally connectable
 Universellement connectable
 Universalmente conectable
 Universalmente collegabile

Balancierter Schwerpunkt
 Balanced centre of gravity
 Centre de gravité équilibré
 Centro de gravedad equilibrado
 Baricentro bilanciato



Ermüdungsfreie Handhabung
 Effortless handling
 Manipulation sans fatigue
 Manejo sin fatiga
 Utilizzo senza affaticamento

Verschiedene Ausführungen
 Various versions
 Diversité des modèles
 Diferentes modelos
 Diverse versioni

Gebogenes Scherenblatt
 Curved scissor blade
 Lames courbées des ciseaux
 Hoja de la tijera curva
 Lama delle forbici curve

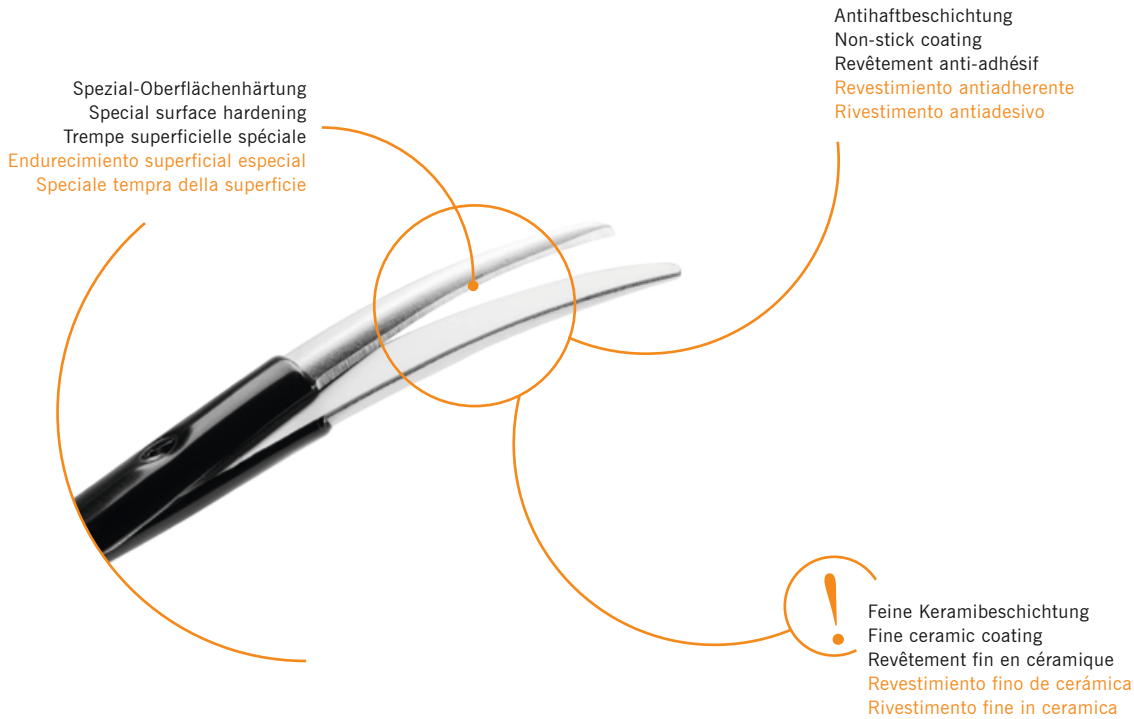

Flächige Koagulation
Zone coagulation
Coagulation de grandes surfaces
Coagulación superficial
Coagulazione di grandi superfici



Koagulieren vor dem Schneiden
Coagulation prior to cutting
Coagulation avant la coupe
Coagulación antes del corte
Coagulazione prima del taglio



Koagulieren während des Schneidens
Coagulation during cutting
Coagulation pendant la coupe
Coagulación durante el corte
Coagulazione durante il taglio



Punktformige Koagulation
Pinpoint coagulation
Coagulation ponctuelle
Coagulación puntiforme
Coagulazione puntiforme

Empfohlene Modi bei BOWA ARC 400
Recommended modes for the BOWA ARC 400
Modes recommandés pour l'ARC 400 de BOWA
Modos recomendados con BOWA ARC 400
Modalità consigliate per BOWA ARC 400



BIZZER® COAG



BIZZER® CUT

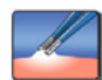

COAG



Metzenbaum



Form Shape Forme Forma Forma	L	STANDARD ohne Kabel without cable sans câble sin cable senza cavo	COMFORT mit Kabel 4.5 m with 4.5 m cable avec câble 4.5 m con cable 4.5 m con cavo da 4,5 m
Gebogen, schlank Curved, precise Courbés, lames minces Acodado, delgado Curva, sottile	180 mm	797-180	797-580 (4.5 m)
	230 mm	797-230	797-630 (4.5 m)
	280 mm	797-280	797-680 (4.5 m)



Metzenbaum fein



Form Shape Forme Forma Forma	L	STANDARD ohne Kabel without cable sans câble sin cable senza cavo	COMFORT mit Kabel 4.5 m with 4.5 m cable avec câble 4.5 m con cable 4.5 m con cavo da 4,5 m
Gebogen, fein Curved, fine Courbés, lames en pointe Acodado, fino Curva, fine	145 mm	798-145	798-545 (4.5 m)
	180 mm	798-180	798-580 (4.5 m)
	230 mm	798-230	798-630 (4.5 m)
	280 mm	798-280	798-680 (4.5 m)





Stevens







Form Shape Forme Forma Forma	L	STANDARD ohne Kabel without cable sans câble sin cable senza cavo	COMFORT mit Kabel 4.5 m with 4.5 m cable avec câble 4.5 m con cable 4.5 m con cavo da 4.5 m	
gebogen, spitz curved, pointed courbés, pointus acodada, punta curva, a punta	145 mm	795-145	795-545 (4.5 m)	
	180 mm	795-180	795-580 (4.5 m)	

Mayo



Form Shape Forme Forma Forma	L	STANDARD ohne Kabel without cable sans câble sin cable senza cavo	COMFORT mit Kabel 4.5 m with 4.5 m cable avec câble 4.5 m con cable 4.5 m con cavo da 4.5 m	
Gebogen Curved Courbés Acodado Curva	170 mm	796-170	796-570 (4.5 m)	

Geräteseitig / At the unit / Côté appareil / En el lado del aparato / Parte generatore

				
	BOWA Valleylab	Erbe	Martin	
Instrumentenseitig At the instrument Côté instrument Lado del instrumento Parte strumento		378-045 (4.5 m)	378-145 (4.5 m)	378-245 (4.5 m)

6 LIGATION Gefäßversiegelung
 Vascular sealing
 Scellement vasculaire
 Sellado de vasos
 Sintesi dei vasi

6.1	ERGO 315R
6.2	ERGO 310D
6.3	NightKNIFE®
6.4	LIGATOR®
6.5	TissueSeal® PLUS

<p>Alle wiederverwendbaren Instrumente werden im unsterilen Zustand angeliefert und können bei 134 °C / 20 min sterilisiert werden.</p> <p>Alle Einmalprodukte sind nicht für den mehrmaligen Gebrauch vorgesehen.</p> <p>Für die allgemeine Wischdesinfektion können handelsübliche Mittel verwendet werden.</p> <p>Für unsachgemäße Reinigung, Sterilisation und Anwendung kann seitens BOWA keine Haftung übernommen werden.</p> <p>Die Produkte tragen das CE Zeichen nach Richtlinie 93 / 42 / EWG</p>	<p>All reusable instruments are supplied in an unsterile state and can be sterilised at 134 °C for 20 min.</p> <p>All single-use products are not intended for multiple usage.</p> <p>Commercially available agents can be used for general wiping and disinfection.</p> <p>BOWA can accept no liability for improper cleaning, sterilisation and use.</p> <p>The products are certified according to 93 / 42 / EEC</p>	<p>Tous les instruments réutilisables sont livrés non stériles et peuvent être stérilisés à 134 °C / 20 min.</p> <p>Aucun produit à usage unique n'est destiné à être réutilisé.</p> <p>Des produits courants disponibles dans le commerce peuvent être utilisés pour un lavage désinfectant général.</p> <p>BOWA exclue toute responsabilité quant au nettoyage, à la stérilisation ou à l'utilisation non conformes ou inappropriés.</p> <p>Les produits sont certifiés selon la directive 93 / 42 / CEE</p>
---	---	--



Todos los instrumentos reutilizables se suministran en estado no estéril y deben ser esterilizados a 134 °C / 20 min.

Todos los productos desechables no son previstos para reutilización.

Para la desinfección superficial general pueden utilizarse productos comerciales corrientes.

BOWA no asume ningún tipo de responsabilidad por la limpieza, la esterilización y la utilización indebida.

Los productos están certificados según la norma 93 / 42 / CEE

Tutti gli strumenti riutilizzabili sono forniti non sterili e possono essere sterilizzati per 20 min a 134 °C.

Tutti i prodotti monouso sono destinati a non essere riutilizzati.

Per la pulizia e la disinfezione generale è possibile utilizzare i prodotti in commercio.

BOWA non si assume alcuna responsabilità per la pulizia, la sterilizzazione e l'uso non conforme.

I prodotti sono certificati in accordo con la norma 93 / 42 / CEE

6.1 ERGO 315R



360° Rotation
360° rotation
Rotation à 360°
Rotación de 360°
Rotazione di 360°

Handschalter
Manual switch
Commutateur manuel
Interruptor manual
Interruttore manuale

Schneidefunktion
Cutting function
Fonction coupe
Función de corte
Funzione di taglio

Multifunktionshebel: Dissezieren, Greifen, Präparieren
Multifunction lever/trigger: opening, closing and locking
Manette multifonction/déclencheur : ouvrir, fermer, verrouiller
Mango/disparador multifunción: abrir, cerrar, fijar
Leva multifunzione/trigger: apertura, chiusura, blocco



Keramik-Mikroverzahnung
Ceramic micro-teeth
Micro-pointe céramique
Microdentado de cerámica
Microdentatura in ceramica

Reflektionsarme Oberfläche
Low-reflection surface
Surface antireflet
Superficies antirreflejo
Superficie antiriflesso

Gewebestopp
Tissue stop
Sécurité tissulaire
Tope de tejido
Blocco dei tessuti

Minimaler Thermal Spread
Minimal thermal spread
Diffusion thermique minimale
Mínima difusión térmica
Dispersione termica minimizzata

Empfohlene Modi bei BOWA ARC 400
Recommended modes for the BOWA ARC 400
Modes recommandés pour l'ARC 400 de BOWA
Modos recomendados con BOWA ARC 400
Modalità consigliate per BOWA ARC 400



LIGATION



ARCSeal



Individuell positionierbar
Individual positioning
Positionnement personnalisable
Posicionable individualmente
Posizione personalizzabile

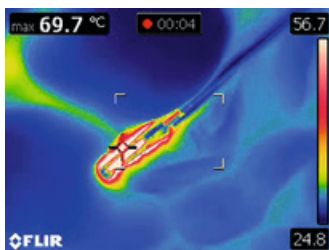

Filigrane Instrumentenspitze
Fine instrument tip
Extrémité filigrane de l'instrument
Estilizada punta del instrumento
Punta dello strumento fine



Viszeralchirurgie
Visceral Surgery
Chirurgie viscérale
Cirugía visceral
Chirurgia digestiva

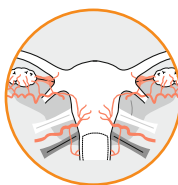

Gynäkologie
Gynaecology
Gynécologie
Ginecología
Ginecologia



Urologie
Urology
Urologie
Urología
Urologia

6.1 ERGO 315R





			Kompletteinstrument Complete instrument Instrument complet Instrumento completo Strumento completo	
			275 mm	
			770-502	
Handgriff Handle Poignée Mango Manipolo		770-510	●	●
Maulteil Jaws Mâchoire Mordaza Morso	275 mm	770-522	●	
	360 mm	770-523		●
Schubrohr Thrust tube Conduit télescopique Tubo Tubo scorrevole	275 mm	770-532	●	
	360 mm	770-533		●
Messerstange Blade rod Porte-lame Varilla de la cuchilla Asta della lama	275 mm	770-542	●	
	360 mm	770-543		●
Klinge steril (10 St.) Blade sterile (quantity 10) Lame stérile (10 pcs) Lámina de corte estéril (10 ud.) Lama sterile (10 pz.) sterile (10 pz.)		770-998	● (2x)	● (2x)
Kabel mit Handschalter Cable with manual switch Câble avec commutateur manuel Cable con interruptor manual Cavo con interruttore manuale		358-245	●	●

6.1 ERGO 315R mit Aufbereitungssieb
with reprocessing basket
avec panier de lavage
con bandeja
con contenitore per ricondizionamento

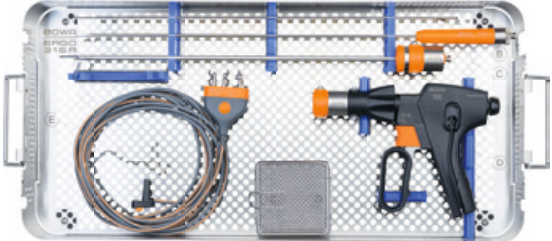

		Kompletteinstrument mit Aufbereitungssieb Complete instrument with reprocessing basket Instrument complet avec panier de lavage Instrumento completo con bandeja Strumento completo con contenitore per ricondizionamento		Kompletteinstrument mit Aufbereitungssieb Complete instrument with reprocessing basket Instrument complet avec panier de lavage Instrumento completo con bandeja Strumento completo con contenitore per ricondizionamento	
		275 mm		360 mm	
		770-552		770-553	
ERGO 315R	275 mm	770-502	●		
	360 mm	770-503		●	
Aufbereitungssieb Reprocessing basket Panier de lavage Bandeja Contenitore per ricondizionamento		773-982	●	●	
Deckel für Sieb Tray lid Couvercle pour panier de lavage Tapa para bandeja Coperchio per contenitore		773-983	●	●	
Reinigungsadapter Set Cleaning adapter kit Jeu d'adaptateur pour le lavage Juego de adaptadores de limpieza Adattatore per lavaggio set		723-050	●	●	
Reinigungsbürsten Set (4 St.) Cleaning brushes kit (quantity 4) Jeu de brosses de lavage (4 pcs) Juego de cepillos de limpieza (4 Ud.) Spazzole per la pulizia set (4 pz.)		723-000	●	●	

	723-051	Reinigungsadapter Maulteil/Handgriff Cleaning adapter handle/jaw Adaptateur de nettoyage insert/poignée Adaptador de limpieza mango/mandíbula Adattatore per la pulizia impugnatura/inserto
	723-052	Reinigungsadapter Schubrohr Cleaning adapter push rod Adaptateur de nettoyage conduit de poussée Adaptador de limpieza tubo de empuje Adattatore per la pulizia tubo d'attivazione

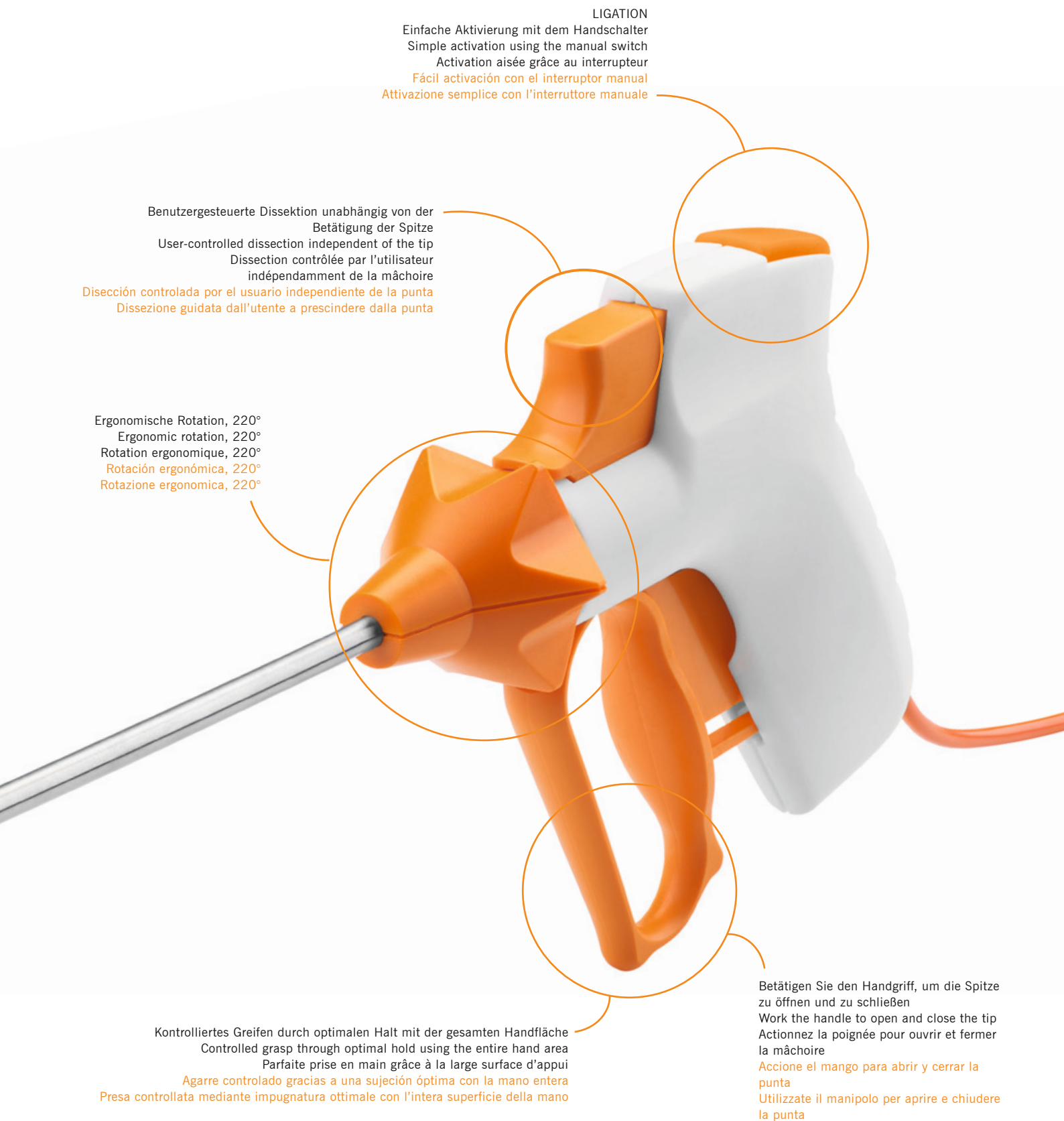

LIGATION
Einfache Aktivierung mit dem Handschalter
Simple activation using the manual switch
Activation aisée grâce au interrupteur
Fácil activación con el interruptor manual
Attivazione semplice con l'interruttore manuale

Benutzergesteuerte Dissektion unabhängig von der
Betätigung der Spitze
User-controlled dissection independent of the tip
Dissection contrôlée par l'utilisateur
indépendamment de la mâchoire
Dissección controlada por el usuario independiente de la punta
Dissezione guidata dall'utente a prescindere dalla punta

Ergonomische Rotation, 220°
Ergonomic rotation, 220°
Rotation ergonomique, 220°
Rotación ergonómica, 220°
Rotazione ergonomica, 220°

Kontrolliertes Greifen durch optimalen Halt mit der gesamten Handfläche
Controlled grasp through optimal hold using the entire hand area
Parfaite prise en main grâce à la large surface d'appui
Agarre controlado gracias a una sujeción óptima con la mano entera
Presa controllata mediante impugnatura ottimale con l'intera superficie della mano

Betätigen Sie den Handgriff, um die Spitze
zu öffnen und zu schließen
Work the handle to open and close the tip
Actionnez la poignée pour ouvrir et fermer
la mâchoire
Accione el mango para abrir y cerrar la
punta
Utilizzate il manopolo per aprire e chiudere
la punta

Glatte Oberflächen für minimierte Anhaftungen
Smooth surfaces to minimize adhesions
Surfaces lisses pour une adhérence minimale
Superficies lisas para una adherencia mínima
Superfici lisce per ridurre al minimo le aderenze

Spiegel- und reflektionsfrei
Non-glare and non-reflecting
Sans effet miroir ni reflet
Sin reflejo ni reflexión
Antiriflesso

Isolation der gesamten Oberfläche der Elektroden
Insulation of the entire electrode surface
Isolation totale des surfaces d'électrode
Aislamiento de toda la superficie de los electrodos
l'isolamento dell'intera superficie degli elettrodi

Minimale Thermal Spread
Minimum thermal spread
Diffusion thermique minimale
Mínima difusión térmica
Spread termico minimo



Gewebe greifen
Grasp the tissue
Saisir les tissus
Agarrar el tejido
Afferrare il tessuto

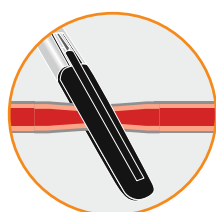

ERGO 310D schließen und einrasten
Close and engage the ERGO 310D
Fermer et enclencher l'ERGO 310D
Cerrar ERGO 310D y enclavar
Chiudere ERGO 310D e agganciarlo



ERGO 310D aktivieren bis das Signal ertönt
Activate the ERGO 310D until the signal sounds
Activer l'ERGO 310D jusqu'à ce que le signal retentisse
Activar ERGO 310D hasta que suene la señal
Attivare ERGO 310D fino all'emissione del segnale acustico



Versiegeltes Gewebe mit dem integrierten Messer durchtrennen
Separate the sealed tissue using the integrated blade
Sectionner le tissu scellé avec la lame intégrée
Cortar el tejido sellado con la cuchilla integrada
Separare il tessuto sigillato con il bisturi integrato

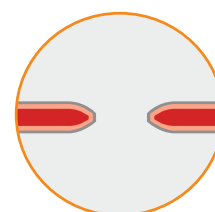

ERGO 310D öffnen
Open the ERGO 310D
Ouvrir l'ERGO 310D
Abrir ERGO 310D
Aprire ERGO 310D

Empfohlene Modi bei BOWA ARC 400
Recommended modes for the BOWA ARC 400
Modes recommandés pour l'ARC 400 de BOWA
Modos recomendados con BOWA ARC 400
Modalità consigliate per BOWA ARC 400



LIGATION



ARCSeal

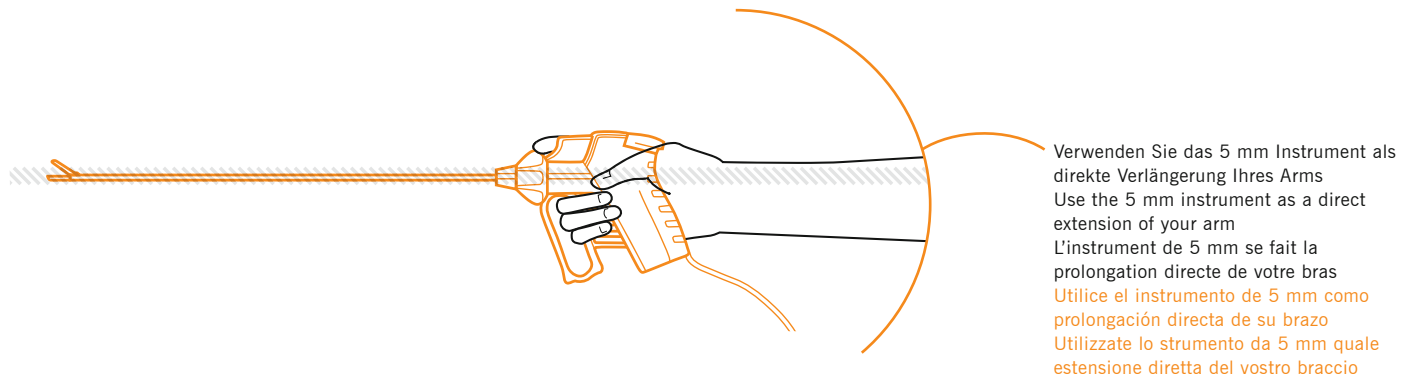

Die abgerundete Geometrie der Spitze erlaubt eine Vielzahl an PräparationsTechniken
 The rounded geometry of the tip allows for numerous preparation techniques
 La forme arrondie de la mâchoire permet de nombreuses techniques de préparation
 La geometría redondeada de la punta permite utilizar un gran número de técnicas de preparación
 La geometria arrotondata della punta permette svariate tecniche di preparazione



Integrierter Schneide-Mechanismus
 Integrated cutting mechanism
 Mécanisme de coupe intégré
 Mecanismo de corte integrado
 Meccanismo di taglio integrato

Der untere Teil der Spitze bietet eine stabile Basis zur Präparation
 The lower part of the tip provides a stable base for preparation
 La partie inférieure de la mâchoire offre une base stable pour la préparation
 La parte inferior de la punta ofrece una base estable para la preparación
 La parte inferiore della punta offre una base stabile per la preparazione

Isolierte Oberflächen
 Insulated surfaces
 Surfaces isolées
 Superficies aisladas
 Superfici isolate

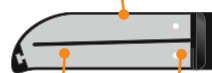

Aktive Elektrode
 Active electrode
 Électrode active
 Electrodo activo
 Elettrodo attivo

Keramik Mikroverzahnung für optimalen Halt am Gewebe
 Ceramic-serration for optimal hold on tissue
 Micro pointe céramique pour un maintien optimal des tissus
 Microdientes cerámicas para una sujeción óptima del tejido
 Micro-dentatura in ceramica per l'ottimale presa del tessuto

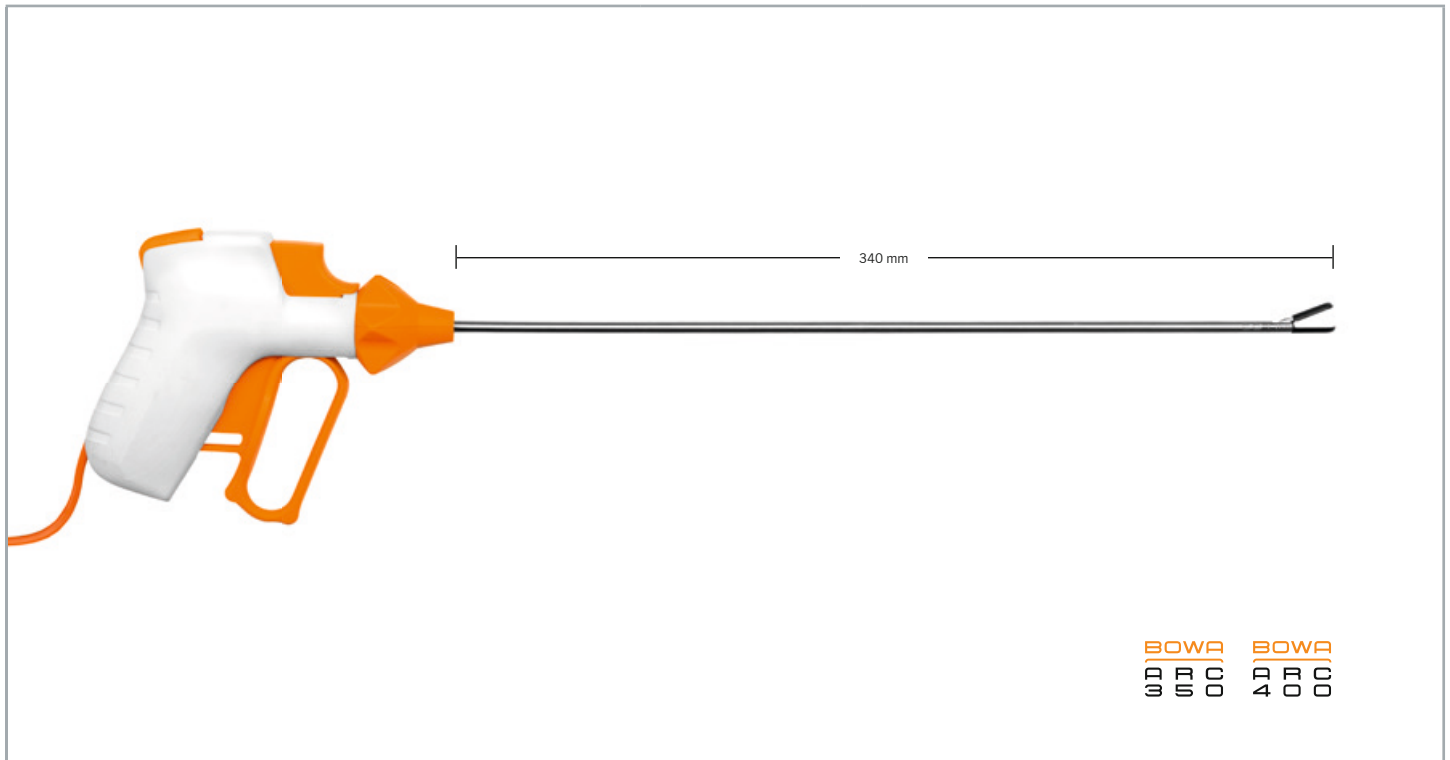

BOWA **BOWA**
A A C **A A C**
3 5 0 **4 0 0**

	<p>775-000</p>	<p>ERGO 310D, Laparoskopisches Ligationsinstrument, Ø 5 mm, 340 mm (5 Stk.) Laparoscopic vessel sealer, Ø 5 mm, 340 mm (5 pcs.) Instrument lap. de thermofusion, Ø 5 mm, 340 mm (5 pcs.) Sellador de vasos laparoscópico, Ø 5 mm, 340 mm (5 uds.) Strumento lap. per la sintesi dei vasi, Ø 5 mm, 340 mm (5 pz.)</p>
--	----------------	---



Viszeralchirurgie
Visceral Surgery
Chirurgie viscérale
Cirugia visceral
Chirurgia digestiva



Gynäkologie
Gynaecology
Gynécologie
Ginecologia
Ginecologia



Urologie
Urology
Urologie
Urologia
Urologia

6.3 NightKNIFE®



Zeitsparend – Kostensparend – Fremdkörperfrei
Time-saving – Cost-saving – Debris-free
Gain de temps – Réduction des coûts – Sans corps étranger
Ahorro de tiempo – Ahorro de costes – Sin residuos
Risparmio di tempo – Risparmio di costi – Assenza di materiale estraneo



10 mm

Isolierte Oberflächen für geringen Thermal Spread
Insulated surfaces for less thermal spread
Surfaces isolées pour une propagation thermique latérale minimale
Superficies aisladas para una menor propagación lateral del calor
Superfici isolate per la minima diffusione termica laterale

Integrierter Schneidmechanismus
erspart Instrumentenwechsel
Integrated cutting mechanism saves
having to change instruments
Le système de coupe intégrée évite
un changement d'instrument
Mecanismo de corte integrado para
ahorrar el cambio de instrumentos
Il meccanismo di taglio integrato
evita il cambio di strumento



Minimaler Thermal Spread
Minimal thermal spread
Dispersion thermique minimale
Propagación térmica mínima
Minima diffusione termica

Atraumatische Spitzen für sichere Präparation
Atraumatic tips for secure dissecting
Mâchoire atraumatique pour une préparation en toute sécurité
Puntas atraumaticas para la preparación segura
Punte atraumatiche per una preparazione sicura

Empfohlener Modus bei BOWA ARC 400
Recommended mode for the BOWA ARC 400
Mode recommandé pour l'ARC 400 de BOWA
Modo recomendado con BOWA ARC 400
Modalità consigliata per BOWA ARC 400



LIGATION

Integrierter Schneidmechanismus
erspart Instrumentenwechsel
Integrated cutting mechanism saves
having to change instruments
Le système de coupe intégrée évite
un changement d'instrument
Mecanismo de corte integrado para
ahorrar el cambio de instrumentos
Il meccanismo di taglio integrato
evita il cambio di strumento

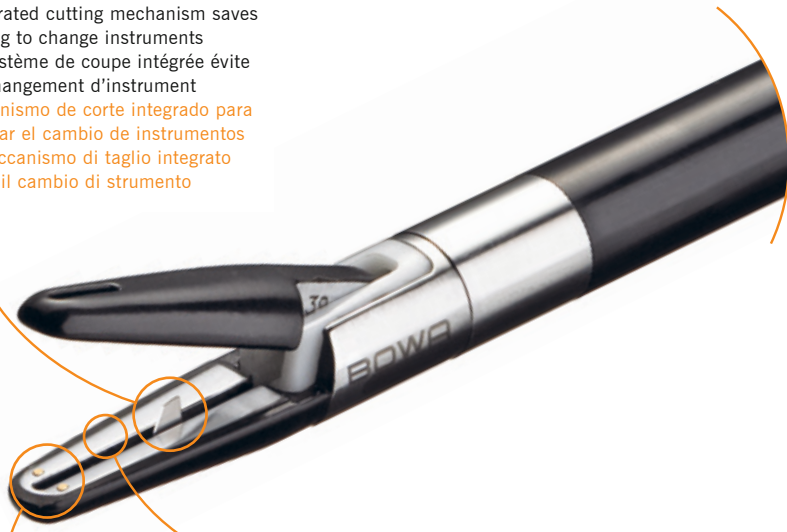

Antihftbeschichtung
Non-stick coating
Traitement anti-adhésif
Revestimiento antiadherente
Rivestimento antiadesivo

Gewebehaltepunkte
Points for tissue grip
Micro-point de maintien du tissu
Puntos de agarre del tejido
Punti di presa tissutale



Sicherer Klinsenwechsel mit Clipapplikator
Safe blade change due to clip applicator
Changement de lame sûr avec l'applicateur
Cambio seguro de la cuchilla con el aplicador
Cambio sicuro della lama con applicatore clip

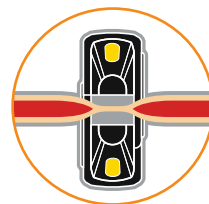
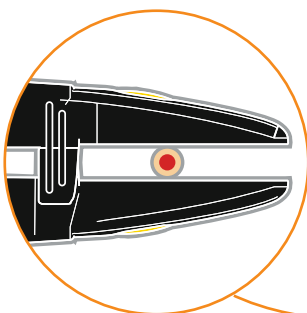

Gefäße bis 7 mm und 700 mm Hg
Vessels up to 7 mm and 700 mm Hg burst
Les vaisseaux jusqu'à 7 mm et 700 mm Hg de pression
Vasos de hasta 7 mm y 700 mm Hg
Vasi fino a 7 mm e resistenza a 700 mm Hg

Viszeralchirurgie
Visceral Surgery
Chirurgie viscérale
Cirugía visceral
Chirurgia digestiva

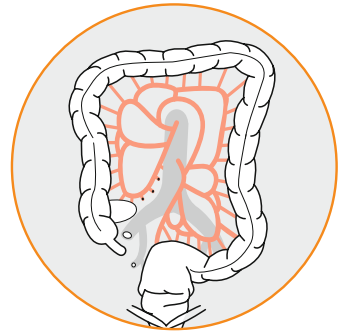

Gynäkologie
Gynaecology
Gynécologie
Ginecologia
Ginecologia

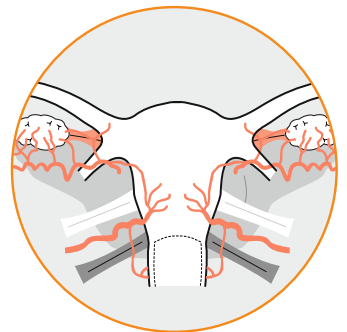

Urologie
Urology
Urologie
Urologia
Urologia

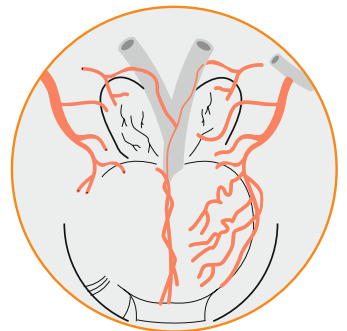

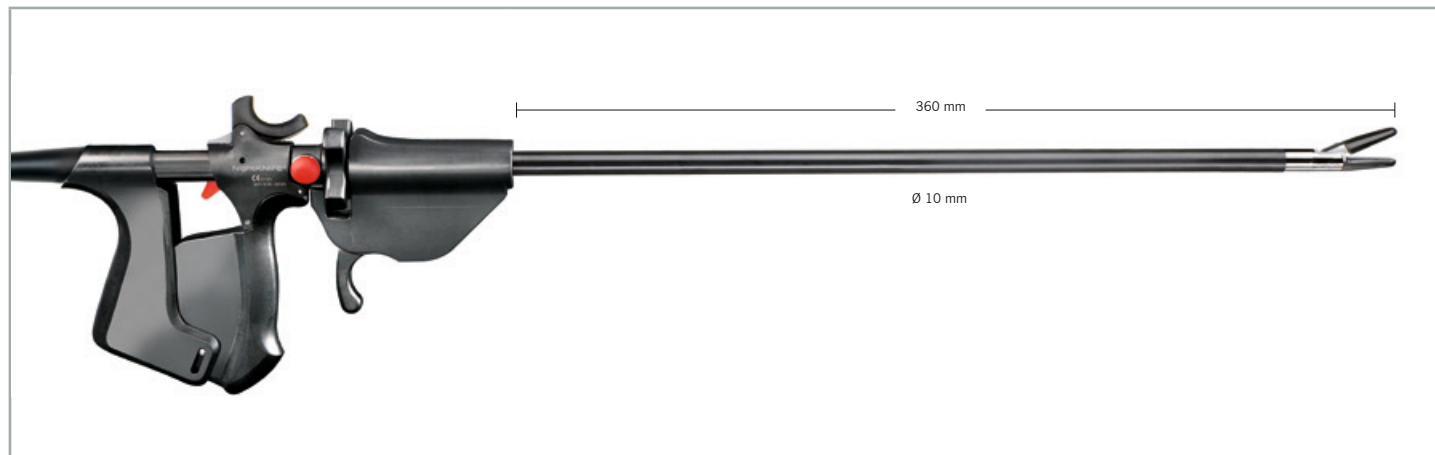



770-300	<p>NightKNIFE® Handgriff, Schaftrohr, Maulteil, 360 mm, COMFORT, Kabel 4.5 m NightKNIFE® handle, shaft tube, jaw, 360 mm, COMFORT, cable, 4.5 m NightKNIFE® manche, conduit, insert, 360 mm, COMFORT, câble, 4.5 m NightKNIFE® mango, tubo, inserto, 360 mm, COMFORT, cable 4.5 m NightKNIFE® manipolo, asta tubolare, inserto, 360 mm, COMFORT, cavo 4.5 m</p>
770-200	<p>NightKNIFE® Handgriff, Schaftrohr, Maulteil, 200 mm, COMFORT, Kabel, 4.5 m NightKNIFE® handle, shaft tube, jaw, 200 mm, COMFORT, cable, 4.5 m NightKNIFE® manche, conduit, insert, 200 mm, COMFORT, câble, 4.5 m NightKNIFE® mango, tubo, inserto, 200 mm, COMFORT, cable 4.5 m NightKNIFE® manipolo, asta tubolare, inserto, 200 mm, COMFORT, cavo 4.5 m</p>
770-301	<p>NightKNIFE® Handgriff, Schaftrohr, Maulteil, auswechselbares Messer, 360 mm, COMFORT, Kabel, 4.5 m NightKNIFE® handle, shaft tube, jaw, exchangeable knife, 360 mm, COMFORT, cable, 4.5 m NightKNIFE® manche, conduit, insert, couteau interchangeable, 360 mm, COMFORT, câble, 4.5 m NightKNIFE® mango, tubo, inserto, cuchillo recambiable, 360 mm, COMFORT, cable 4.5 m NightKNIFE® manipolo, asta tubolare, inserto, lama sostitutiva, 360 mm, COMFORT, cavo 4.5 m</p>
770-201	<p>NightKNIFE® Handgriff, Schaftrohr, Maulteil, auswechselbares Messer, 200 mm, COMFORT, Kabel, 4.5 m NightKNIFE® handle, shaft tube, jaw, exchangeable knife, 200 mm, COMFORT, cable, 4.5 m NightKNIFE® manche, conduit, insert, couteau interchangeable 200 mm, COMFORT, câble, 4.5 m NightKNIFE® mango, tubo, inserto, cuchillo recambiable, 200 mm, COMFORT, cable 4.5 m NightKNIFE® manipolo, asta tubolare, inserto, lama sostitutiva, 200 mm, COMFORT, cavo 4.5 m</p>





770-000	<p>NightKNIFE® & LIGATOR® Handgriff, COMFORT, Kabel, 4.5 m NightKNIFE® & LIGATOR® Handle, COMFORT, cable, 4.5 m NightKNIFE® & LIGATOR® Manche, COMFORT, câble, 4.5 m NightKNIFE® & LIGATOR® Mango, COMFORT, cable 4.5 m NightKNIFE® & LIGATOR® Manipolo, COMFORT, cavo 4.5 m</p>
---------	--











	770-336	Schaftrohr, 360 mm Shaft tube, 360 mm Conduit, 360 mm Tubo, 360 mm Tubo, 360 mm
	770-320	Schaftrohr, 200 mm Shaft tube, 200 mm Conduit, 200 mm Tubo, 200 mm Tubo, 200 mm

	771-136	NightKNIFE® Maulteil, gerade, 360 mm NightKNIFE® jaw, straight, 360 mm Insert NightKNIFE®, droit, 360 mm Inserto NightKNIFE®, recto, 360 mm Inserto NightKNIFE®, retto, 360 mm
	771-137	NightKNIFE® Maulteil, gerade, auswechselbares Messer, 360 mm NightKNIFE® jaw, straight, exchangeable knife, 360 mm Insert NightKNIFE®, droit, couteau interchangeable, 360 mm Inserto NightKNIFE®, recto, cuchillo recambiable, 360 mm Inserto NightKNIFE®, retto, lama ricambiabile, 360 mm
	771-120	NightKNIFE® Maulteil, gerade, 200 mm NightKNIFE® jaw, straight, 200 mm Insert NightKNIFE®, droit, 200 mm Inserto NightKNIFE®, recto, 200 mm Inserto NightKNIFE®, retto, 200 mm
	771-121	NightKNIFE® Maulteil, gerade, auswechselbares Messer, 200 mm NightKNIFE® jaw, straight, exchangeable knife, 200 mm Insert NightKNIFE®, droit, couteau interchangeable, 200 mm Inserto NightKNIFE®, recto, cuchillo recambiable, 200 mm Inserto NightKNIFE®, retto, lama ricambiabile, 200 mm

	770-999	NightKNIFE® Messer / 5 Stk. NightKNIFE® Blade / 5 pcs. NightKNIFE® Couteau / 5 pcs. NightKNIFE® Cuchillo / 5 uds. NightKNIFE® Lama / 5 pz.	
---	---------	--	---



 <p>360 mm</p> <p>∅ 5 mm</p>	<p>770-036</p>	<p>LIGATOR® Handgriff, Schaftrohr 360 mm und Ersatzdichtungen, COMFORT, Kabel, 4.5 m LIGATOR® Handle, shaft tube 360 mm and sealing spare parts, COMFORT, cable, 4.5 m LIGATOR® Manche, conduit 360 mm et joints de rechange, COMFORT, câble, 4.5 m LIGATOR® Mango, tubo 360 mm y juntas de recambio, COMFORT, cable 4.5 m LIGATOR® Manipolo, asta tubolare 360 mm e guarnizioni da ricambio, COMFORT, cavo 4.5 m</p>
 <p>∅ 5 mm</p>	<p>770-236</p>	<p>Schaftrohr 360 mm Shaft tube 360 mm Conduit 360 mm Tubo 360 mm Tubo 360 mm</p>
	<p>771-036</p>	<p>Maulteil, gerade, gezahnt, 360 mm Jaw for forceps, straight, toothed, 360 mm Mâchoire, droite, dentée, 360 mm Inserto pinza recta, 360 mm Inserto pinza retta dentata, 360 mm</p>
	<p>771-011</p>	<p>Maulteil, gerade, gezahnt, 110 mm Jaw for forceps, straight, toothed, 110 mm Mâchoire, droite, dentée, 110 mm Inserto pinza, recto, dentado, 110 mm Inserto pinza retta dentata, 110 mm</p>
	<p>772-036</p>	<p>Maulteil Maryland, gebogen, gezahnt, 360 mm Jaw for forceps Maryland, curved, toothed, 360 mm Mâchoires Maryland, courbé, dentées, 360 mm Inserto pinza, acodado, dentad, tipo Maryland, 360 mm Inserto Maryland, curvo, dentato, 360 mm</p>
	<p>772-011</p>	<p>Maulteil Maryland, gebogen, gezahnt, 110 mm Jaw for forceps Maryland, curved, toothed, 110 mm Mâchoire Maryland, courbée, dentée, 110 mm Inserto pinza, acodado tipo Maryland, dentado, 110 mm Inserto Maryland, curvo, dentato, 110 mm</p>

<p>Ersatzdichtungen Sealing spare parts Set de joints de rechange Juntas de recambio Set di guarnizioni di ricambio</p>		<p>723-020</p>
		
<p>4 Reinigungsbürsten, LAP 4 Cleaning brushes, LAP 4 Brosses de nettoyage, LAP 4 Escobillas de limpieza, LAP 4 Spazzole per la pulitura, LAP 2 x Ø 6 x 500 mm, 2 x Ø 4 x 500 mm</p>	<p>723-000</p>	

6.5 TissueSeal® PLUS

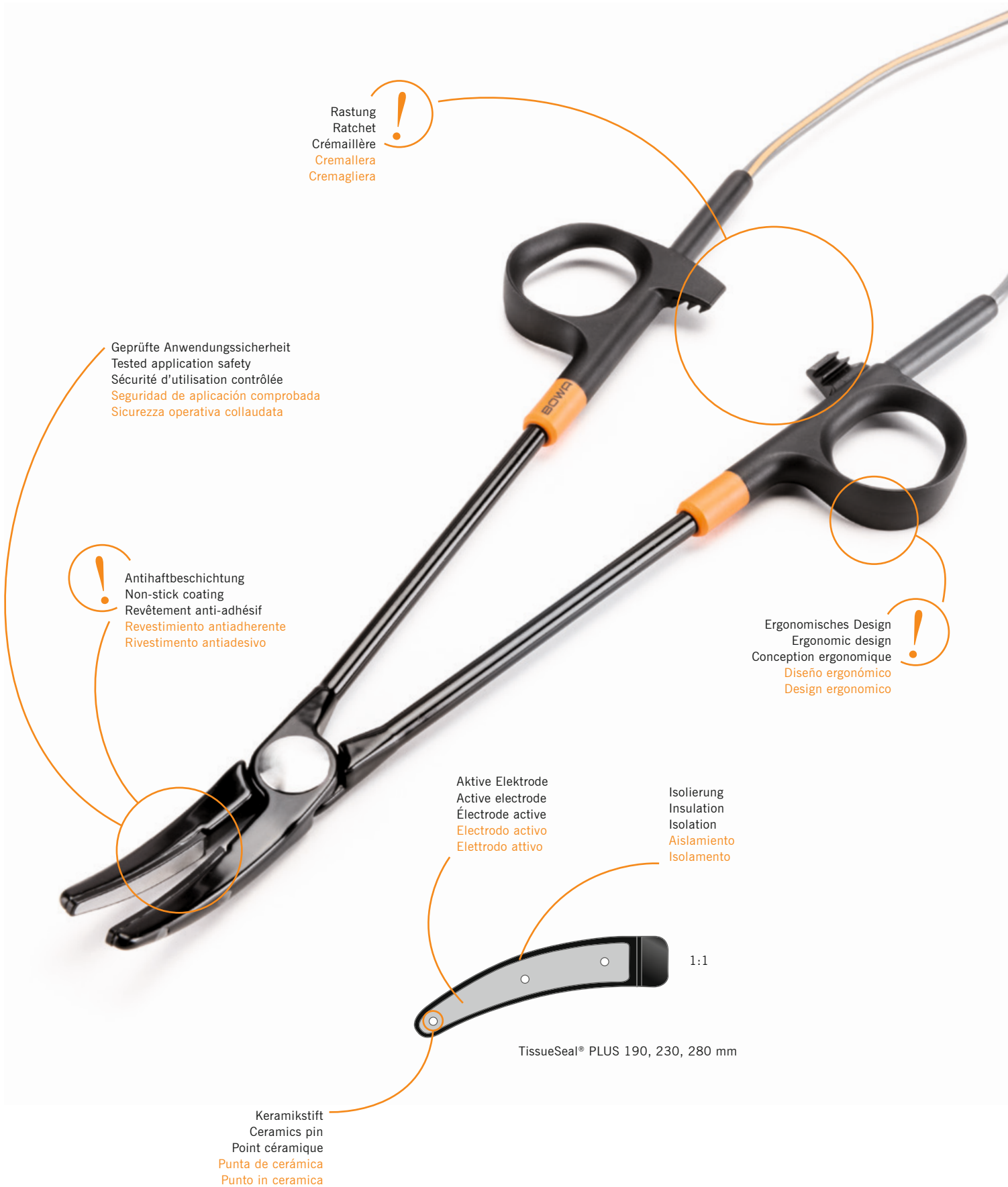

Gebogene Maulform
Curved mouth shape
Forme courbée de la mâchoire
Punta curvada
Punte curvante

Filigrane Spitze
Fine point
Pointe filigrane
Puntas filigranas
Punta filigrana

Aktive Elektrode
Active electrode
Électrode active
Electrodo activo
Elettrodo attivo

! Minimum Thermal Spread
dank Sandwichaufbau
Minimum thermal spread
due to the sandwich structure
Dispersion thermique minimale
grâce à la structure en « sandwich »
Mínima difusión térmica
por la estructura en sándwich
Minima dispersione termica
grazie alla struttura a sandwich

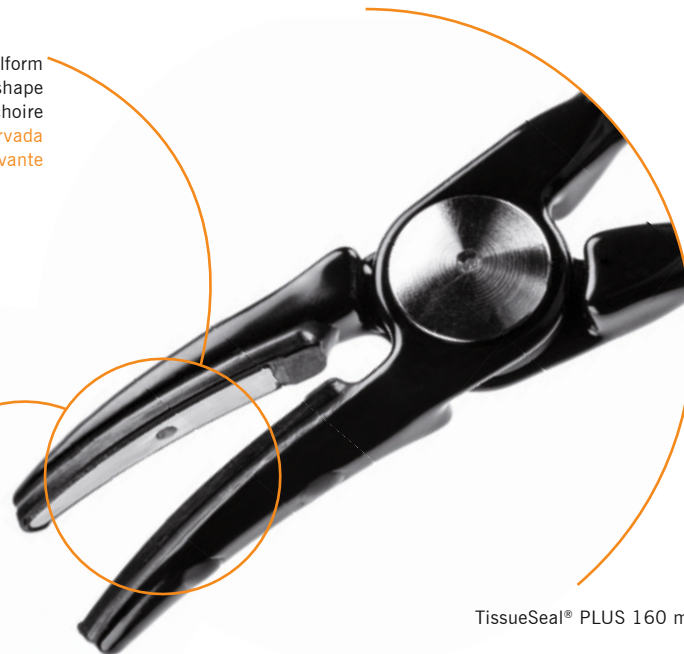

TissueSeal® PLUS 160 mm

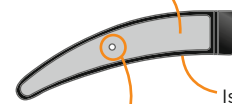

1:1

Keramikstift
Ceramics pin
Point céramique
Pin en cerámica
Punto in ceramica

Isolierung
Insulation
Isolation
Aislamiento
Isolamento



Gewebe fassen
Hold the tissue
Saisir les tissus
Fijar el tejido
Prendere il tessuto



TissueSeal® PLUS schließen und rasten
Close and lock the TissueSeal® PLUS
Fermer et enclencher la poignée
TissueSeal® PLUS
Cerrar y enclavar TissueSeal® PLUS
Chiudere la TissueSeal® PLUS e serrare
la cremagliera



LIGATION bis Signal ertönt
LIGATE until the signal sounds
Ligaturer jusqu'à ce que le
signal retentisse
LIGAR hasta que suena la señal
Sintetizzare fino al segnale
acustico

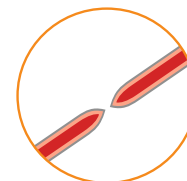

LIGATION trennen
Separate the LIGATION
Couper la ligature
Separar la LIGADURA
Separare la ligazione



Viszeralchirurgie
Visceral Surgery
Chirurgie viscérale
Cirugía visceral
Chirurgia digestiva

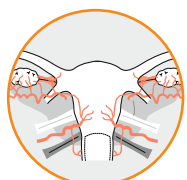

Gynäkologie
Gynaecology
Gynécologie
Ginecologia
Ginecologia



Urologie
Urology
Urologie
Urologia
Urologia

Empfohlener Modus bei BOWA ARC 400
Recommended mode for the BOWA ARC 400
Mode recommandé pour l'ARC 400 de BOWA
Modo recomendado con BOWA ARC 400
Modalità consigliata per BOWA ARC 400



TissueSeal® PLUS



Thyridektomie
 Thyroidectomy
 Thyroidectomie
 Tiroidectomía
 Tiroidectomia

760-216

COMFORT
 Kabel, 4.5 m
 Cable, 4.5 m
 Câble, 4.5 m
 Cable, 4.5 m
 Cavo, 4.5 m

760-219

COMFORT
 Kabel, 4.5 m
 Cable, 4.5 m
 Câble, 4.5 m
 Cable, 4.5 m
 Cavo, 4.5 m

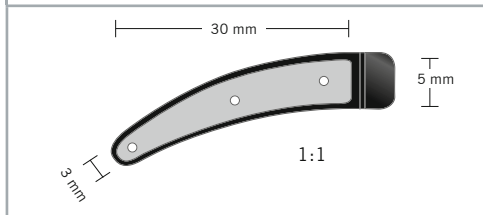
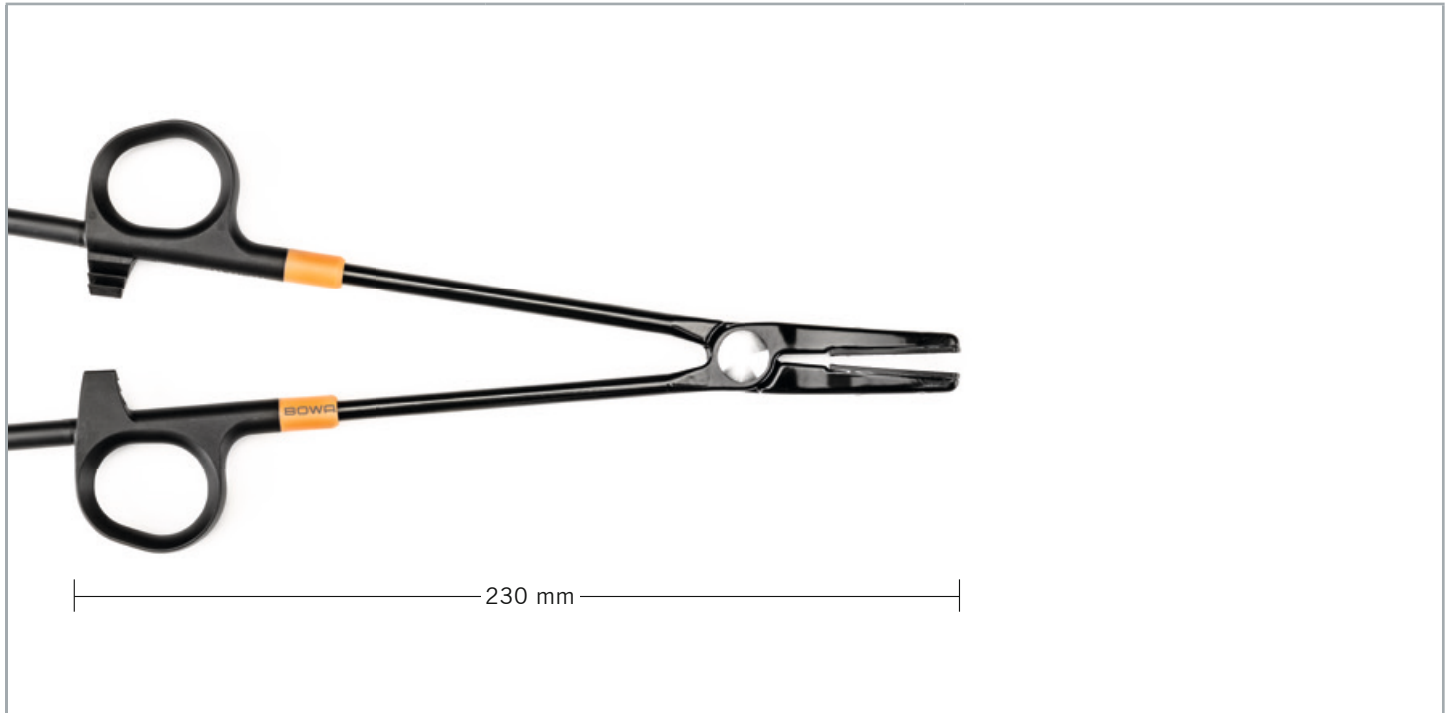

760-223

COMFORT
Kabel, 4.5 m
Cable, 4.5 m
Câble, 4.5 m
Cable, 4.5 m
Cavo, 4.5 m

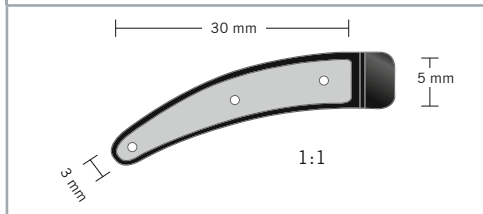
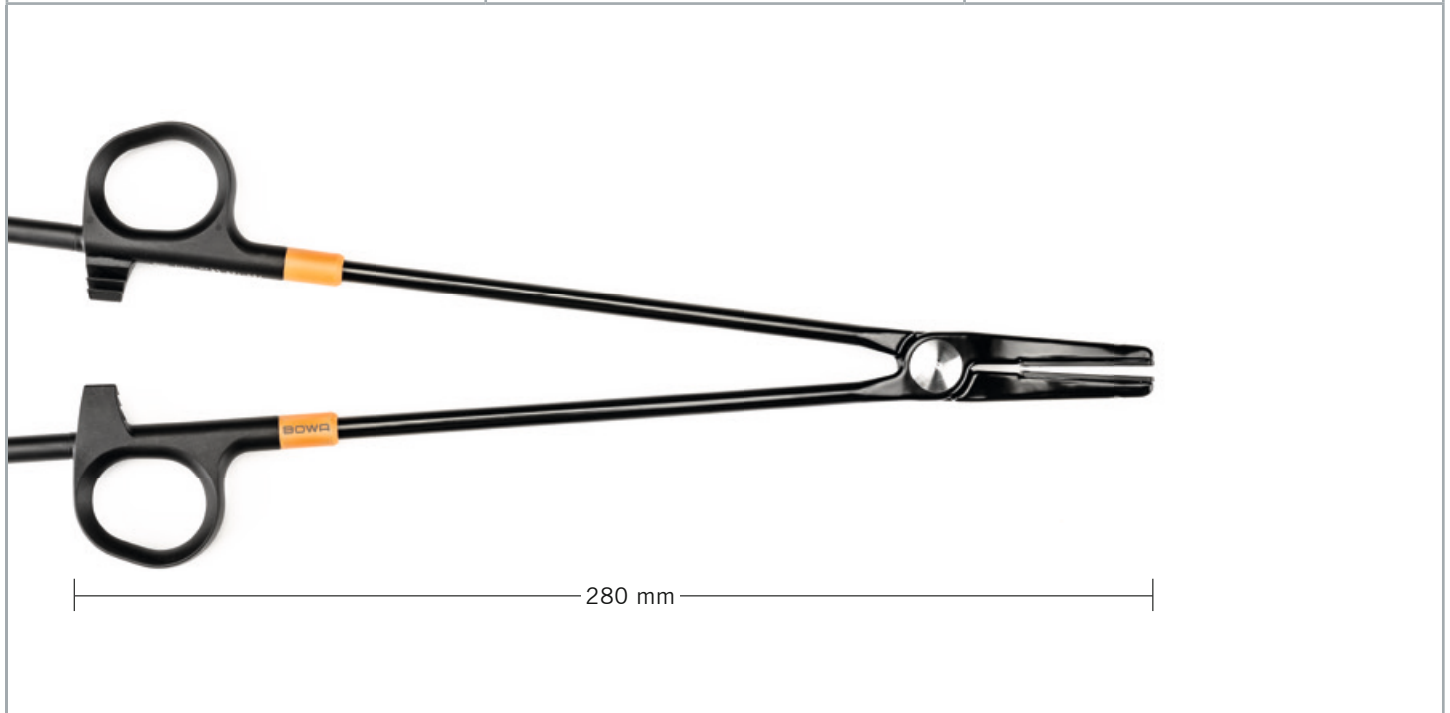

760-228

COMFORT
Kabel, 4.5 m
Cable, 4.5 m
Câble, 4.5 m
Cable, 4.5 m
Cavo, 4.5 m

7 Argon assistierte Elektrochirurgie
 Argon-assisted electrosurgery
 Électrochirurgie assistée à l'argon
 Electrocirugía asistida con argón
 Elettrochirurgia coadiuvata ad argon

7.1 Offene und laparoskopische Anwendung 7.2 Flexible Anwendung 7.2.1 Flexible Anwendung Einmalverwendung 7.2.2 Flexible Anwendung wiederverwendbar 7.2.3 Anschlusskabel Argon 7.2.4 Argon Zubehör	7.1 Open and laparoscopic application 7.2 Flexible application 7.2.1 Flexible application disposable 7.2.2 Flexible application reusable 7.2.3 Connecting cables Argon 7.2.4 Argon Accessories	7.1 Application invasive et laparoscopique 7.2 Application endoscopique 7.2.1 Application endoscopique à usage unique 7.2.2 Application endoscopique réutilisable 7.2.3 Câbles de raccordement Argon 7.2.4 Argon Accessoires
7.1 Aplicación abierta y laparoscópica 7.2 Aplicación flexible 7.2.1 Aplicación flexible desechables 7.2.2 Aplicación flexible reutilizable 7.2.3 Cables de conexión argón 7.2.4 Argon Accesorios	7.1 Applicazione invasiva e laparoscopica 7.2 Applicazione endoscopica flessibile 7.2.1 Applicazione flessibile monouso 7.2.2 Applicazione flessibile riutilizzabile 7.2.3 Cavi di collegamento Argon 7.2.4 Argon Accessori	

<p>Alle wiederverwendbaren Instrumente werden im unsterilen Zustand angeliefert und können bei 134 °C / 20 min sterilisiert werden.</p> <p>Alle Einmalprodukte sind nicht für den mehrmaligen Gebrauch vorgesehen.</p> <p>Für die allgemeine Wischdesinfektion können handelsübliche Mittel verwendet werden.</p> <p>Für unsachgemäße Reinigung, Sterilisation und Anwendung kann seitens BOWA keine Haftung übernommen werden.</p> <p>Die Produkte tragen das CE Zeichen nach Richtlinie 93 / 42 / EWG</p>	<p>All reusable instruments are supplied in an unsterile state and can be sterilised at 134 °C for 20 min.</p> <p>All single-use products are not intended for multiple usage.</p> <p>Commercially available agents can be used for general wiping and disinfection.</p> <p>BOWA can accept no liability for improper cleaning, sterilisation and use.</p> <p>The products are certified according to 93 / 42 / EEC</p>	<p>Tous les instruments réutilisables sont livrés non stériles et peuvent être stérilisés à 134 °C / 20 min.</p> <p>Aucun produit à usage unique n'est destiné à être réutilisé.</p> <p>Des produits courants disponibles dans le commerce peuvent être utilisés pour un lavage désinfectant général.</p> <p>BOWA exclue toute responsabilité quant au nettoyage, à la stérilisation ou à l'utilisation non conformes ou inappropriés.</p> <p>Les produits sont certifiés selon la directive 93 / 42 / CEE</p>
---	---	--



Todos los instrumentos reutilizables se suministran en estado no estéril y deben ser esterilizados a 134 °C / 20 min.

Todos los productos desechables no son previstos para reutilización.

Para la desinfección superficial general pueden utilizarse productos comerciales corrientes.

BOWA no asume ningún tipo de responsabilidad por la limpieza, la esterilización y la utilización indebida.

Los productos están certificados según la norma 93 / 42 / CEE

Tutti gli strumenti riutilizzabili sono forniti non sterili e possono essere sterilizzati per 20 min a 134 °C.

Tutti i prodotti monouso sono destinati a non essere riutilizzati.

Per la pulizia e la disinfezione generale è possibile utilizzare i prodotti in commercio.

BOWA non si assume alcuna responsabilità per la pulizia, la sterilizzazione e l'uso non conforme.

I prodotti sono certificati in accordo con la norma 93 / 42 / CEE

7.1 Offene und laparoskopische Anwendung
 Open and laparoscopic application
 Application invasive et laparoscopique
 Aplicación abierta y laparoscópica
 Applicazione invasiva e laparoscopica



Effizient – Berührungslos – Rauchfrei
 Efficient – Contactless – Smoke free
 Efficaces – Sans contact – Sans fumée
 Eficiente – Sin contacto – Sin humo
 Efficiente – Senza contatto – Senza fumo

6-Kant-Codierung
 Hexagon coding
 Codage hexagonal
 Codificación hexagonal
 Codificazione esagonale

4600V_p

Peek-Isolation
 Peek insulation
 Isolation Peek
 Aislamiento en Peek
 isolamento in Peek

Keramik-Isolation
 Ceramics insulation
 Isolation céramique
 Aislamiento en cerámica
 Isolamento in ceramica

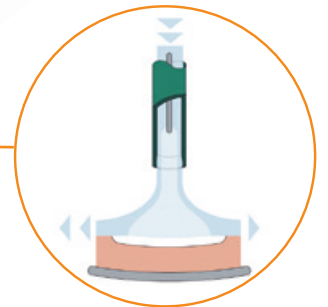

Optimiertes Strömungsverhalten für hervorragende Zündung
 Optimized flow behaviour for excellent ignition
 Débit optimisé pour un excellent amorçage
 Régimen de corriente optimizado para un encendido perfecto
 Proprietà di conduzione ottimizzata, per un innesco eccezionale

Empfohlene Modi bei BOWA ARC 400
 Recommended modes for the BOWA ARC 400
 Modes recommandés pour l'ARC 400 de BOWA
 Modos recomendados con BOWA ARC 400
 Modalità consigliate per BOWA ARC 400



Argon CUT



Argon COAG



932-042

Argon-Handgriff COMFORT, Kabel 3.5 m
Argon handle COMFORT, cable 3.5 m
Manche Argon COMFORT, câble 3.5 m
Mango para argón COMFORT, cable 3.5 m
Manipolo portaelettrodi per argon COMFORT,
cavo 3.5 m

BOWA
ARC
PLUS

7.1 Offene und laparoskopische Anwendung
 Open and laparoscopic application
 Application invasive et laparoscopique
 Aplicación abierta y laparoscópica
 Applicazione invasiva e laparoscopica

134°C
 Autoclave
 273°F



	932-035	100 mm	<div style="border: 1px solid orange; padding: 5px; display: inline-block; margin-bottom: 10px;">4600V_P</div> <p>Starre Argon-Nadel-Schneide- und Koagulationselektrode Rigid Argon needle cutting and coagulation electrode Electrode aiguille pour argon coupe et coagulation Electrodo rígido de argón tipo aguja, para cortar y coagular Elettrodo rigido ad ago per taglio e coagulazione con argon</p>
	932-055	100 mm	<div style="border: 1px solid orange; padding: 5px; display: inline-block; margin-bottom: 10px;">4600V_P</div> <p>Starre Argon-Messer-Schneide- und Koagulationselektrode Rigid Argon knife cutting and coagulation electrode Electrode couteau pour argon coupe et coagulation Electrodo rígido de argón tipo cuchilla, para cortar y coagular Elettrodo rigido a lama per taglio e coagulazione con argon</p>
	932-058	150 mm	
	932-059	370 mm	



4200V_p

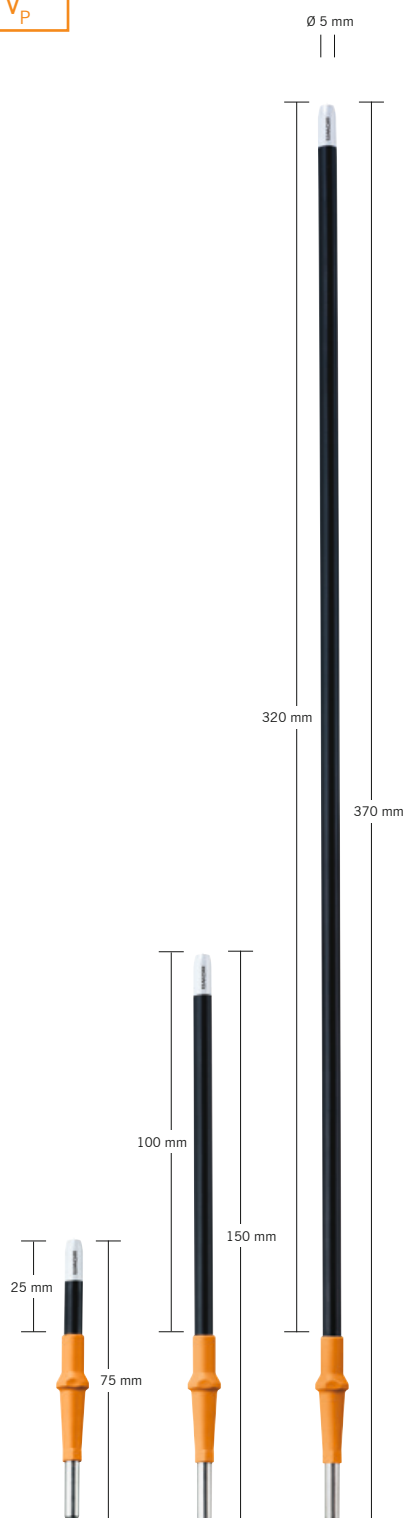

932-031

75 mm

932-032

150 mm

932-034

370 mm

Starre Argon-Koagulationselektrode
Rigid Argon coagulation electrode
Électrode rigide de coagulation à l'argon
Electrodo de coagulación rígido para argón
Elettrodo rigido per argon

4600V_p

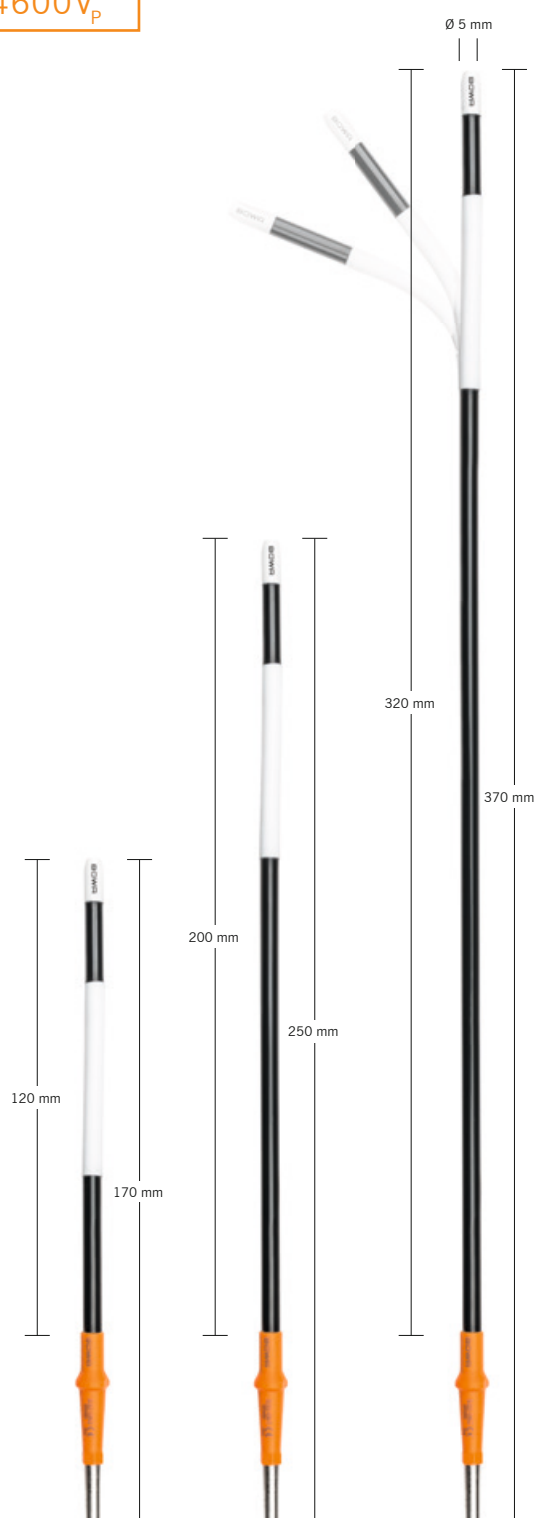

932-060

170 mm

932-061

250 mm

932-062

370 mm

Argon-Koagulationselektrode, biegsam
Argon coagulation electrode, bendable
Électrode de coagulation à l'argon, pliable
Electrodo de coagulación con argón, flexible
Elettrodo curvabile per argon

7.2 Flexible Anwendung
 Flexible application
 Application endoscopique
 Aplicación flexible
 Applicazione endoscopica flessibile



Sicheres Arbeiten und Perforationsschutz
 Safe electrosurgery and reduced risk of perforation
 Une sécurité renforcée et une protection maximale contre la perforation
 Trabajar con seguridad y protección contra la perforación
 Lavoro sicuro e protezione dalla perforazione

5200V_p

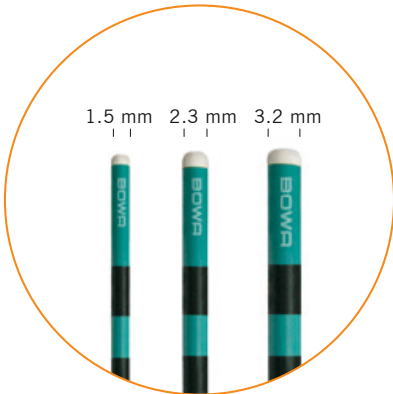

Skala
 Scale
 Graduation
 Escala
 Scala

Optimaler Farbkontrast
 Optimum colour contrast
 Un contraste de couleurs optimal
 Óptimo contraste de color
 Contrasto ottimale dei colori

Atraumatische Keramikspitze
 Blunt ceramic tip
 Buses céramique arrondies
 Punta de cerámica redonda
 Punta in ceramica atraumatica



134°C
 Autoclave
 273°F

Optimiertes Strömungsverhalten
 Optimised flow behaviour
 Comportement d'écoulement optimisé
 Óptimo comportamiento de flujo
 Comportamento ottimizzato del flusso di gas



90°

90° Sidefire-Ausführung
 90° Sidefire version
 Modèle 90° Latéral
 Modelo 90° lateral
 Versione Sidefire 90°

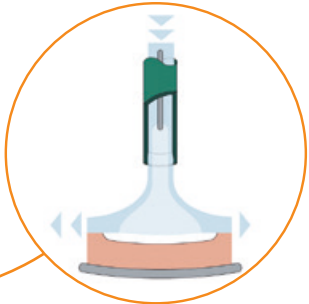

Empfohlene Modi bei BOWA ARC 400
 Recommended modes for the BOWA ARC 400
 Modes recommandés pour l'ARC 400 de BOWA
 Modos recomendados con BOWA ARC 400
 Modalità consigliate per BOWA ARC 400









Argon PULSED



Argon FLEX





7.2.1 Flexible Anwendung – Einmalverwendung
 Flexible application – disposable
 Application endoscopique – à usage unique
 Aplicación flexible – desechable
 Applicazione flessibile – monouso



STERIL, 10 St. / VPE STERILE, 10 pcs / PU STÉRILE, 10 pièces / unité cond. ESTÉRIL, 10 uds. / unidad de embalaje STERILE, 10 pz. / confezione		Ø	Länge Length Longueur Longitud Lunghhezza	Argon-Strahl Beam of argon Jet d'argon Chorro de argón Raggio argon
 <p>○ Ø 1.5 mm</p>	932-248	1.5 mm	1.5 m	
 <p>○ Ø 1.5 mm</p>	932-251	1.5 mm	3 m	
 <p>○ Ø 2.3 mm</p>	932-249	2.3 mm	2.2 m	Axial Axial Axial Axial Assiale
 <p>○ Ø 2.3 mm</p>	932-252	2.3 mm	3 m	
 <p>○ Ø 3.2 mm</p>	932-250	3.2 mm	2.2 m	
<p>○ Ø 2.3 mm</p>	932-253	2.3 mm	2.2 m	Lateral Lateral Latéral Lateral Laterale

7.2.2 Flexible Anwendung – wiederverwendbar
 Flexible application – reusable
 Application endoscopique – réutilisable
 Aplicación flexible – reutilizable
 Applicazione flessibile – riutilizzabile





UNSTERIL, 1 St. / VPE UNSTERILE, 1 pc / PU NON-STÉRILE, 1 pièce / unité cond. NO ESTÉRIL, 1 ud. / unidad de embalaje NON STERILE, 1 pz. / VPE		∅	Länge Length Longueur Longitud Lunghezza	Argon-Strahl Beam of argon Jet d'argon Chorro de argón Raggio argon
 <p>∅ 1.5 mm</p>	932-148	1.5 mm	1.5 m	
	932-151	1.5 mm	3 m	
 <p>∅ 2.3 mm</p>	932-154	2.3 mm	1 m	
 <p>∅ 2.3 mm</p>	932-149	2.3 mm	2.2 m	Axial Axial Axial Axial Assiale
 <p>∅ 2.3 mm</p>	932-152	2.3 mm	3 m	
 <p>∅ 3.2 mm</p>	932-150	3.2 mm	2.2 m	
 <p>∅ 2.3 mm</p>	932-153	2.3 mm	2.2 m	Lateral Lateral Latéral Lateral Laterale

7.2.3 Anschlusskabel Argon
 Connecting cables Argon
 Câbles de raccordement Argon
 Cables de conexión argón
 Cavi di collegamento Argon



134°C
 Autoclave
 273°F



932-146			
<p>Anschlusskabel für flexible Argonsonden, 2.5 m lang, Anschluss 3-pin für HF und Luer Lock für Argon Gas Connecting cable for flexible Argon probes, 2.5 m long, 3-pin connector for HF and Luer Lock connection for Argon gas Câble de raccordement pour sondes flexibles à l'argon, longueur 2.5 m, connecteur à 3 broches pour HF et raccord de gaz Luer Lock pour l'argon Cable de conexión para sondas de argón flexibles, 2.5 m de largo, conector 3-pin para AF y Luer Lock para gas argón Cavo di collegamento per sonde flessibili ad argon, lunghezza 2.5 m, attacco a 3 pin per alta frequenza e Luer Lock per gas argon</p>			

7.2.4 Argon Zubehör
 Argon Accessories
 Argon Accessoires
 Argon Accesorios
 Argon Accessori



	830-050	<p>Sterilfilter-Set / 50 Stk. Sterile filter set / 50 pcs. Filtres stériles / 50 pcs. Juego de filtros esteriles / 50 uds. Set filtri sterili / 50 pz.</p> 
	932-910	<p>Spüladapter für flexible Argonsonden zum Anschluss an Spülmaschinen / 5 Stk. Rinsing adaptor for flexible argon probes to connect to washing machines / 5 pcs. Adaptateur de rinçage pour les sondes flexibles argon pour la connexion aux machines à laver / 5 pcs. Adaptador de enjuague para sondas flexibles de argón, para conectar a lavajillas / 5 uds. Adattore d'irrigazione per il collegamento di sonde flessibili ad argon alle lavastumenti / 5 pz.</p>

8 Neutralelektroden
Neutral electrodes
Electrodes neutres
Electrodos neutros
Elettrodi neutri

8.1 8.2 8.3 8.4	Einmal-Neutralelektroden Anschlusskabel Wiederverwendbare Gummi-Neutralelektroden (Silikon) Zubehör	8.1 8.2 8.3 8.4	Single-use return plates Connecting cable Reusable rubber return plates (silicone) Accessories	8.1 8.2 8.3 8.4	Electrodes neutres à usage unique Câbles de raccordement Electrodes neutres réutilisables en caoutchouc (silicone) Accessoires
8.1 8.2 8.3 8.4	Electrodos neutros desechables Cables de conexión Electrodos neutros de goma reutilizables (silicona) Accesorios	8.1 8.2 8.3 8.4	Piastre neutre monouso Cavi di collegamento Piastre neutre di gomma riutilizzabili (silicone) Accessori		

<p>Alle wiederverwendbaren Instrumente werden im unsterilen Zustand angeliefert und können bei 134 °C / 20 min sterilisiert werden.</p> <p>Alle Einmalprodukte sind nicht für den mehrmaligen Gebrauch vorgesehen.</p> <p>Für die allgemeine Wischdesinfektion können handelsübliche Mittel verwendet werden.</p> <p>Für unsachgemäße Reinigung, Sterilisation und Anwendung kann seitens BOWA keine Haftung übernommen werden.</p> <p>Die Produkte tragen das CE Zeichen nach Richtlinie 93 / 42 / EWG</p>	<p>All reusable instruments are supplied in an unsterile state and can be sterilised at 134 °C for 20 min.</p> <p>All single-use products are not intended for multiple usage.</p> <p>Commercially available agents can be used for general wiping and disinfection.</p> <p>BOWA can accept no liability for improper cleaning, sterilisation and use.</p> <p>The products are certified according to 93 / 42 / EEC</p>	<p>Tous les instruments réutilisables sont livrés non stériles et peuvent être stérilisés à 134 °C / 20 min.</p> <p>Aucun produit à usage unique n'est destiné à être réutilisé.</p> <p>Des produits courants disponibles dans le commerce peuvent être utilisés pour un lavage désinfectant général.</p> <p>BOWA exclue toute responsabilité quant au nettoyage, à la stérilisation ou à l'utilisation non conformes ou inappropriés.</p> <p>Les produits sont certifiés selon la directive 93 / 42 / CEE</p>
---	---	--



Todos los instrumentos reutilizables se suministran en estado no estéril y deben ser esterilizados a 134 °C / 20 min.

Todos los productos desechables no son previstos para reutilización.

Para la desinfección superficial general pueden utilizarse productos comerciales corrientes.

BOWA no asume ningún tipo de responsabilidad por la limpieza, la esterilización y la utilización indebida.

Los productos están certificados según la norma 93 / 42 / CEE

Tutti gli strumenti riutilizzabili sono forniti non sterili e possono essere sterilizzati per 20 min a 134 °C.

Tutti i prodotti monouso sono destinati a non essere riutilizzati.

Per la pulizia e la disinfezione generale è possibile utilizzare i prodotti in commercio.

BOWA non si assume alcuna responsabilità per la pulizia, la sterilizzazione e l'uso non conforme.

I prodotti sono certificati in accordo con 93 / 42 / CEE

8.1 Einmal-Neutralelektroden
Single-use return plates
Electrodes neutres à usage unique
Electrodos neutros desechables
Piastra neutre monouso



Sicherheit zum Aufkleben – Überwachbar
Security for sticking – Monitored
Sécurité prêt à coller – Surveillées
Seguridad para la aplicación – Monitoreable
Sicurezza da applicare – Monitorabile

Anatomisches Design
Anatomic design
Design anatomique
Diseño anatómico
Design anatomico

Innovatives Hydrogel
Innovative hydrogel
Hydrogel innovant
Capa de hidrogel
innovadora
Innovativo idrogel

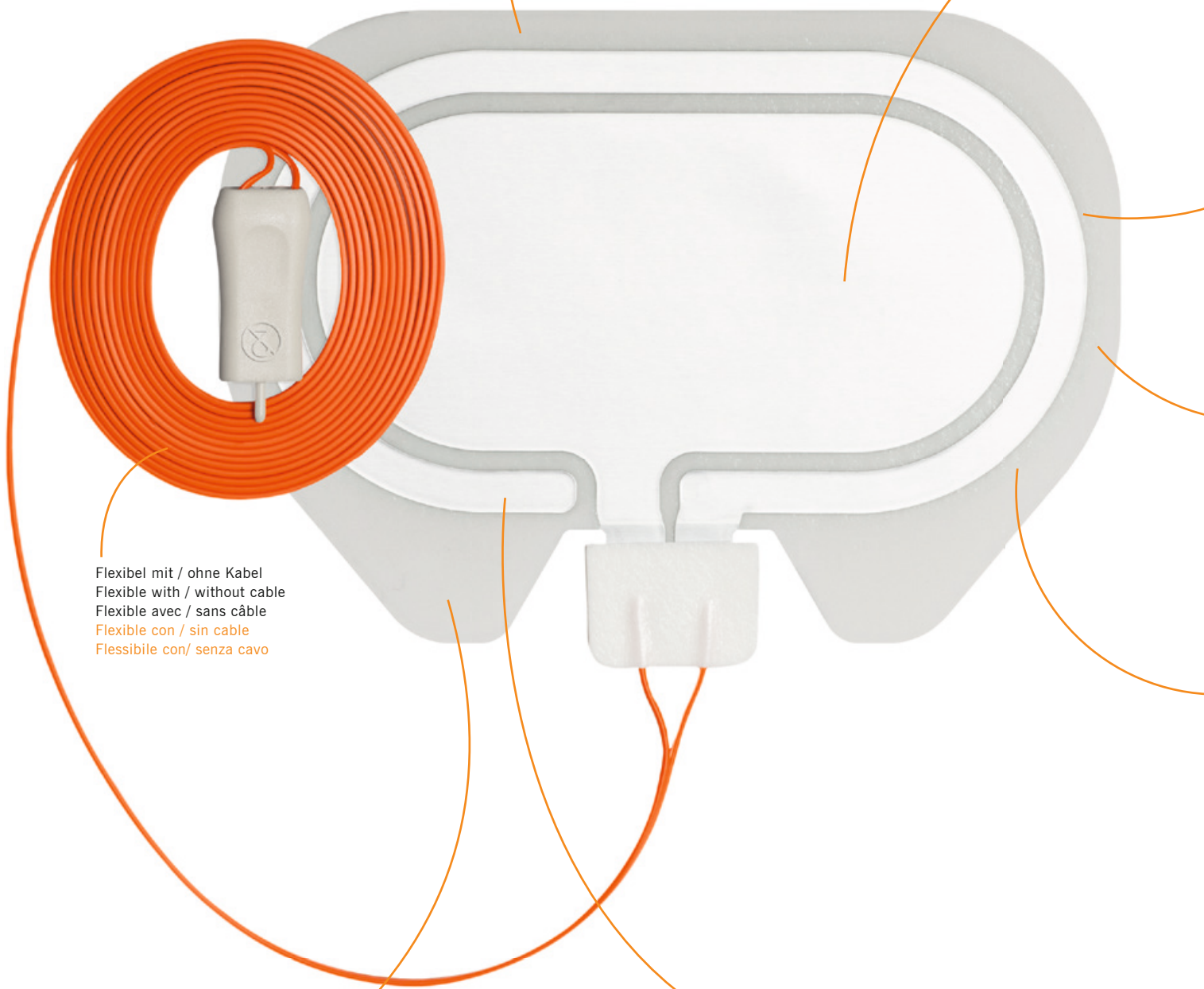

Flexibel mit / ohne Kabel
Flexible with / without cable
Flexible avec / sans câble
Flexible con / sin cable
Flessibile con/ senza cavo

Zugentlastung
Strain relief
Dispositif anti-traction
Descarga de tracción
Fascetta anti-strappo

Sicherheitsring für optimale Stromsymmetrie
Safety ring for optimum current symmetry
Bague de sécurité assurant une symétrie
optimale du courant
Anillo equipotencial de seguridad para una
óptima distribución simétrica
Anello di sicurezza per un'ottimale simmetria
di corrente



EASY universell und richtungsunabhängig einsetzbar
EASY universally attachable and independent of orientation
EASY application universelle et indépendante de l'orientation
EASY aplicación universal e independiente de la orientación
EASY impiego universale con applicazione indipendente dall'orientamento

Elastische Schaumabdeckung für ideale Anpassung
Elastic foam backing for ideal shaping
Supports en mousse élastique permettant une adaptation idéale
El revestimiento de espuma elástica permite una adaptación perfecta
Dorso imbottito in schiuma elastica l'ideale adattamento

Flüssigkeitsabweisend
Liquid-repellent
Surface déperlante
Impermeable
Repellente ai liquidi

Festhaftende Sicherheitsränder
Adhesive safety frame
Cadre de sécurité adhésif
Borde de seguridad adhesivo
Bordo di sicurezza adesivo

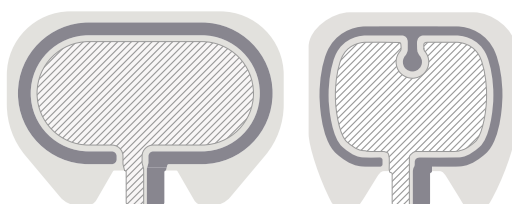

8.1 Einmal-Neutralelektroden
 Single-use return plates
 Electrodes neutres à usage unique
 Electrodoos neutros desechables
 Piastra neutre monouso



Universal Universal Universel Universal Universale	> 5 kg 	
	REF ohne Kabel / 100 Stk. REF without cable / 100 pcs. RÉF sans câble / 100 pcs. Ref. sin cable / 100 uds. REF senza cavo / 100 pz.	REF mit Kabel 3 m / 15 Stk. REF with cable 3 m / 15 pcs. RÉF avec câble 3 m / 15 pcs. Ref. con cable de 3 m / 15 uds. REF con cavo da 3 m / 15 pz.
EASY Universal $A_{\text{cond}^*} = 90 \text{ cm}^2$ GETEILT SPLIT DIVISÉ DIVIDIDO BIPARTITA		
EASY Standard $A_{\text{cond}^*} = 110 \text{ cm}^2$ GETEILT SPLIT DIVISÉ DIVIDIDO BIPARTITA		
Verpackung Packing Emballage Embalaje Confezione		
	816-092	818-092
	816-112	818-112
	5 100 1000	1 15 150
* Kontaktfläche / Conductive surface / Surface conductrice / Superficie condutora / Superficie conduttiva		







<p>Universal Universal Universal Universal Universale</p>	<p>> 5 kg</p>	
	<p>REF ohne Kabel / 100 Stk. REF without cable / 100 pcs. RÉF sans câble / 100 pcs. Ref. sin cable / 100 uds. REF senza cavo / 100 pz.</p>	<p>REF mit Kabel 3 m / 15 Stk. REF with cable 3 m / 15 pcs. RÉF avec câble 3 m / 15 pcs. Ref. con cable de 3 m / 15 uds. REF con cavo da 3 m / 15 pz.</p>
<p>EASY ECO $A_{\text{cond}^*} = 70 \text{ cm}^2$</p> <p>GETEILT SPLIT DIVISÉ DIVIDIDO BIPARTITA</p>		
<p>$A_{\text{cond}^*} = 110 \text{ cm}^2$</p> <p>UNGETEILT NON-SPLIT NON DIVISÉ NO DIVIDIDO MONOPARTITA</p>		
<p>Verpackung Packing Embalaje Confezione</p>	<p>5 100 1000</p>	<p>1 15 150</p>
	<p>816-072</p>	<p>818-072</p>
	<p>815-110</p>	<p>817-110</p>





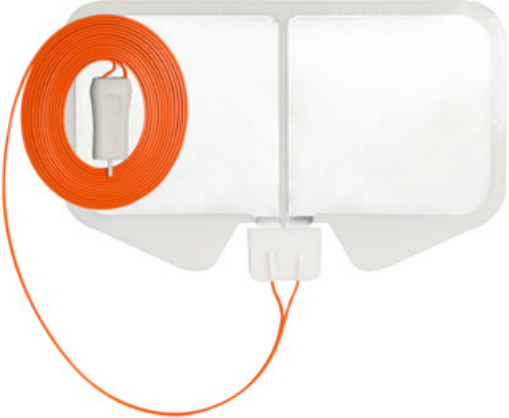
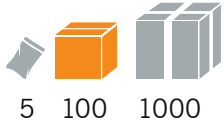
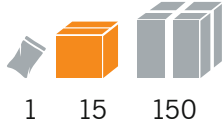

* Kontaktfläche / Conductive surface / Surface conductrice / Superficie condutora / Superficie conduttiva

8.1 Einmal-Neutralelektroden
 Single-use return plates
 Electrodes neutres à usage unique
 Electrodoos neutros desechables
 Piastra neutre monouso



Erwachsene Adult Adultes Adultos Adulti	>15 kg 	
	REF ohne Kabel / 100 Stk. REF without cable / 100 pcs. RÉF sans câble / 100 pcs. Ref. sin cable / 100 uds. REF senza cavo / 100 pz.	REF mit Kabel 3 m / 15 Stk. REF with cable 3 m / 15 pcs. RÉF avec câble 3 m / 15 pcs. Ref. con cable de 3 m / 15 uds. REF con cavo da 3 m / 15 pz.
EASY $A_{\text{cond}} = 160 \text{ cm}^2$ GETEILT SPLIT DIVISÉ DIVIDIDO BIPARTITA		
$A_{\text{cond}} = 160 \text{ cm}^2$ GETEILT SPLIT DIVISÉ DIVIDIDO BIPARTITA		
Verpackung Packing Emballage Embalaje Confezione		
	816-162	818-162
	816-161	818-161
* Kontaktfläche / Conductive surface / Surface conductrice / Superficie conductora / Superficie conduttiva		



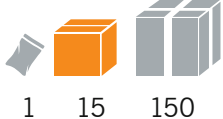







<p>Erwachsene Adult Adultes Adultos Adulti</p>	<p>> 15 kg</p> 	
	<p>REF ohne Kabel / 100 Stk. REF without cable / 100 pcs. RÉF sans câble / 100 pcs. Ref. sin cable / 100 uds. REF senza cavo / 100 pz.</p>	<p>REF mit Kabel 3 m / 15 Stk. REF with cable 3 m / 15 pcs. RÉF avec câble 3 m / 15 pcs. Ref. con cable de 3 m / 15 uds. REF con cavo da 3 m / 15 pz.</p>
<p>$A_{cond^*} = 140 \text{ cm}^2$</p> <p>GETEILT SPLIT DIVISÉ DIVIDIDO BIPARTITA</p>		
	<p>816-141</p>	<p>818-141</p>
<p>$A_{cond^*} = 140 \text{ cm}^2$</p> <p>UNGETEILT NON-SPLIT NON DIVISÉ NO DIVIDIDO MONOPARTITA</p>		
	<p>815-140</p>	<p>817-140</p>
<p>Verpackung Packing Emballage Embalaje Confezione</p>	 <p>5 100 1000</p>	 <p>1 15 150</p>
<p>* Kontaktfläche / Conductive surface / Surface conductrice / Superficie condutora / Superficie conduttiva</p>		

8.1 Einmal-Neutralelektroden
 Single-use return plates
 Electrodes neutres à usage unique
 Electrodo neutros desechables
 Piastra neutre monouso



Kinder Children Enfants Niños Bambini	5 kg – 15 kg 	
	REF ohne Kabel / 100 Stk. REF without cable / 100 pcs. RÉF sans câble / 100 pcs. Ref. sin cable / 100 uds. REF senza cavo / 100 pz.	REF mit Kabel 3 m / 15 Stk. REF with cable 3 m / 15 pcs. RÉF avec câble 3 m / 15 pcs. Ref. con cable de 3 m / 15 uds. REF con cavo da 3 m / 15 pz.
$A_{\text{cond}^*} = 70 \text{ cm}^2$ GETEILT SPLIT DIVISÉ DIVIDIDO BIPARTITA 	 816-071	 818-071
$A_{\text{cond}^*} = 70 \text{ cm}^2$ UNGETEILT NON-SPLIT NON DIVISÉ NO DIVIDIDO MONOPARTITA 	 815-070	 817-070
Verpackung Packing Emballage Embalaje Confezione	 5 100 1000	 1 15 150
* Kontaktfläche / Conductive surface / Surface conductrice / Superficie condutora / Superficie conduttiva		







Neugeborene Newborns Nourrissons Neonatos Neonati	< 5 kg 	
	REF ohne Kabel / 100 Stk. REF without cable / 100 pcs. RÉF sans câble / 100 pcs. Ref. sin cable / 100 uds. REF senza cavo / 100 pz.	REF mit Kabel 3 m / 15 Stk. REF with cable 3 m / 15 pcs. RÉF avec câble 3 m / 15 pcs. Ref. con cable de 3 m / 15 uds. REF con cavo da 3 m / 15 pz.
EASY $A_{cond^*} = 40 \text{ cm}^2$ GETEILT SPLIT DIVISÉ DIVIDIDO BIPARTITA 	 816-042	 818-042
$A_{cond^*} = 40 \text{ cm}^2$ UNGETEILT NON-SPLIT NON DIVISÉ NO DIVIDIDO MONOPARTITA 	 815-040	 817-040
Verpackung Packing Emballage Embalaje Confezione	 5 100 1000	 1 15 150
* Kontaktfläche / Conductive surface / Surface conductrice / Superficie condutora / Superficie conduttiva		

8.2 Anschlusskabel Connecting cable Câbles de raccordement Cables de conexión Cavi di collegamento

134°C
Autoclave
273°F



Stecker, Geräteseite Plug, generator side Connecteur, côté générateur Enchufe, parte generador Spinotto, parte generatore	Stecker, Neutralelektrodenseite Plug, return plate side Connecteur, côté électrode neutre Enchufe, parte electrodo neutro Spinotto, parte piastra neutra	REF	Für Generator Typ For generator type Pour générateur type Para generador tipo Per generatore tipo
		294-050 (4.5 m)	Erbe VIO / ICC / ACC Erbe T-Serie Martin
		101-150 (4.5 m)	ALSA Eschmann*
		380-050 (4.5 m)	BOWA Erbe ICC / VIO International Valleylab REM Conmed
		386-050 (4.5 m)	BOWA Erbe ICC / VIO International Valleylab NON-REM Conmed
<p>* Abhängig von jeweiliger Buchsenkonfiguration Depends on individual socket configuration Dépend de la configuration individuelle du connecteur Depende de la configuración individual de las salidas Dipende dalla configurazione individuale dell'uscita</p>			

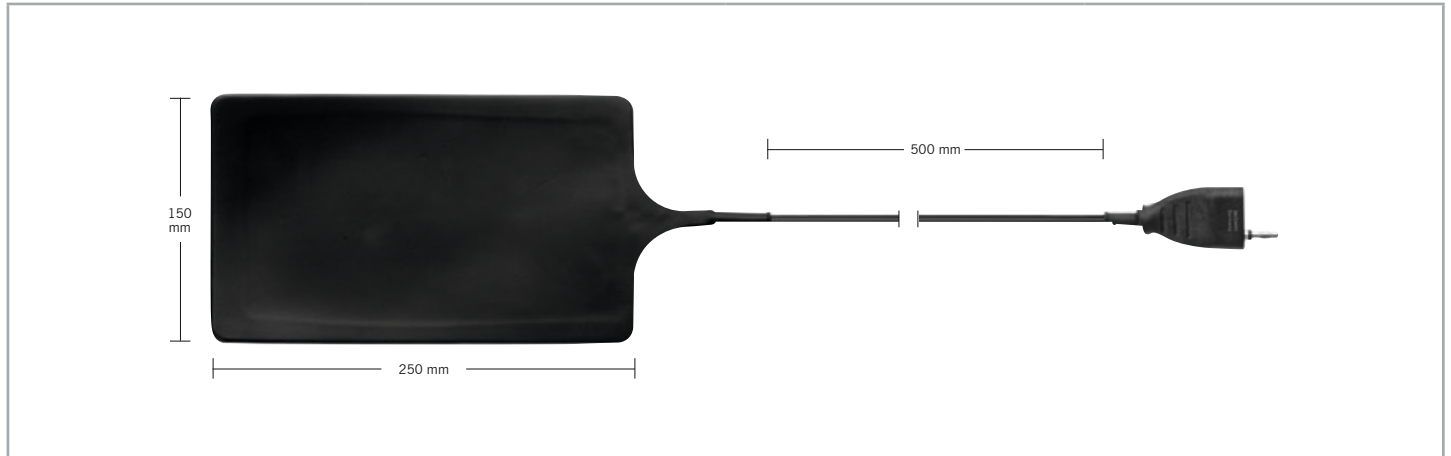

8.3 Wiederverwendbare Gummi-Neutralelektroden (Silikon)
 Reusable rubber return plates (silicone)
 Electrodes neutres réutilisables en caoutchouc (silicone)
 Electrodos neutros de goma reutilizables (silicona)
 Piastra neutre di gomma riutilizzabili (silicone)

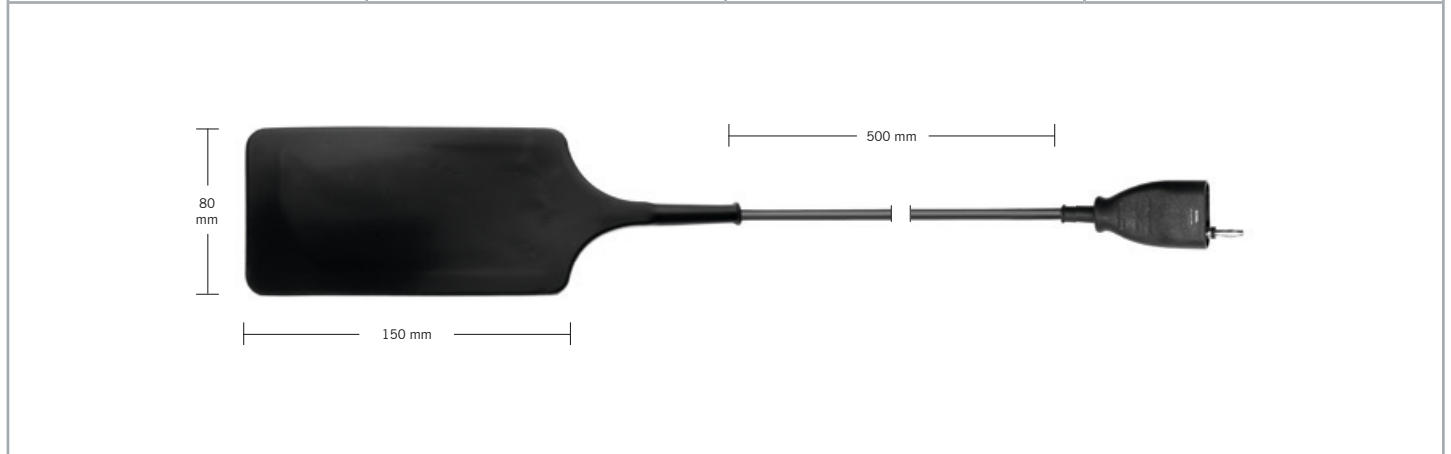

REF	193-008	Für Generatoren For generators Pour générateurs Para generadores Per generatori	Erbe VIO / ICC / ACC Erbe T-Serie
-----	---------	---	--------------------------------------



REF	193-016	Für Generatoren For generators Pour générateurs Para generadores Per generatori	Erbe VIO / ICC / ACC Erbe T-Serie
-----	---------	---	--------------------------------------

Stecker, Geräteseite Plug, generator side Connecteur, côté générateur Enchufe, parte generator Spinotto, parte generatore	Stecker, Neutralelektrodenseite Plug, return plate side Connecteur, côté électrode neutre Enchufe, parte electrodo neutro Spinotto, parte piastra neutra	REF	Für Generator Typ For generator type Pour générateurs type Para generator tipo Per generatore tipo
		101-003 (4.5 m)	Erbe VIO / ICC / ACC Erbe T-Serie

8.3 Wiederverwendbare Gummi-Neutralelektroden (Silikon)
 Reusable rubber return plates (silicone)
 Electrodes neutres réutilisables en caoutchouc (silicone)
 Electrodos neutros de goma reutilizables (silicona)
 Piastra neutre di gomma riutilizzabili (silicone)



REF	242-003	Für Generatoren For generators Pour générateurs Para generadores Per generatori	BOWA ERBE International Martin International Valleylab Conmed
REF	232-003	Für Generatoren For generators Pour générateurs Para generadores Per generatori	BOWA ERBE international Martin Valleylab Conmed

Stecker, Geräteseite Plug, generator side Connecteur, côté générateur Enchufe, parte generator Spinotto, parte generatore	Stecker, Neutralelektrodenseite Plug, return plate side Connecteur, côté électrode neutre Enchufe, parte electrodo neutro Spinotto, parte piastra neutra	REF	Für Generator Typ For generator type Pour générateur type Para generator tipo Per generatore tipo
		295-050 (4.5 m)	Martin
		385-050 (4.5 m)	BOWA ERBE international Martin Valleylab Conmed

8.4 Zubehör
Accessories
Accessoires
Accesorios
Accessori

134°C
Autoclave
273°F



	194-075	<p>Elastische Gummibinde gelocht, mit Befestigungsknopf, 750 mm Rubber band, perforated, with fixing button, 750 mm Bande élastique en caoutchouc, perforée, avec bouton de fixation, 750 mm Cinta de goma elastica, perforada, con botón de fijación, 750 mm Fascia elastica in gomma, forata, con bottone di fissaggio, 750 mm</p>
--	---------	--

9 ARC System und Zubehörteile
 ARC system and accessories
 Systèmes ARC et accessoires
 Sistema ARC y accesorios
 Sistema ARC e accessori

9.1 Elektrochirurgie-Geräte	9.1 Electrosurgical units	9.1 Appareils d'électrochirurgie
9.2 Fußschalter	9.2 Footswitch	9.2 Pédales de commande
9.3 Kommunikations-Interface ARC – ARC PLUS	9.3 Communication interface ARC – ARC PLUS	9.3 Interface de communication ARC – ARC PLUS
9.4 Netzkabel	9.4 Mains cable	9.4 Câble d'alimentation
9.5 Potentialausgleichsleitung	9.5 Equipotential bonding	9.5 Câble équipotentiel
9.6 Druckminderer für ARC PLUS REF 900-000	9.6 Pressure reducer for ARC PLUS REF 900-000	9.6 Manodétendeur pour ARC PLUS REF 900-000
9.7 Druckminderer für ARC PLUS REF 900-001	9.7 Pressure reducer for ARC PLUS REF 900-001	9.7 Manodétendeur pour ARC PLUS REF 900-001
9.8 Argon Gasflasche	9.8 Gas cylinder Argon	9.8 Bouteille de gaz, Argon
9.1 Equipos de electrocirugía	9.1 Generatori elettrochirurgici	
9.2 Conmutador de pie	9.2 Interruttori a pedale	
9.3 Interfaz de comunicación ARC – ARC PLUS	9.3 Interfaccia di comunicazione ARC – ARC PLUS	
9.4 Cable de red	9.4 Cavo di alimentazione	
9.5 Conductor equipotencial	9.5 Conduttore equipotenziale	
9.6 Manorreductor para ARC PLUS REF 900-000	9.6 Riduttore di pressione per ARC PLUS REF 900-000	
9.7 Manorreductor para ARC PLUS REF 900-001	9.7 Riduttore di pressione per ARC PLUS REF 900-001	
9.8 Botella de gas argón	9.8 Bombola gas argon	

<p>Alle wiederverwendbaren Instrumente werden im unsterilen Zustand angeliefert und können bei 134 °C / 20 min sterilisiert werden.</p> <p>Alle Einmalprodukte sind nicht für den mehrmaligen Gebrauch vorgesehen.</p> <p>Für die allgemeine Wischdesinfektion können handelsübliche Mittel verwendet werden.</p> <p>Für unsachgemäße Reinigung, Sterilisation und Anwendung kann seitens BOWA keine Haftung übernommen werden.</p> <p>Die Produkte tragen das CE Zeichen nach Richtlinie 93 / 42 / EWG</p>	<p>All reusable instruments are supplied in an unsterile state and can be sterilised at 134 °C for 20 min.</p> <p>All single-use products are not intended for multiple usage.</p> <p>Commercially available agents can be used for general wiping and disinfection.</p> <p>BOWA can accept no liability for improper cleaning, sterilisation and use.</p> <p>The products are certified according to 93 / 42 / EEC</p>	<p>Tous les instruments réutilisables sont livrés non stériles et peuvent être stérilisés à 134 °C / 20 min.</p> <p>Aucun produit à usage unique n'est destiné à être réutilisé.</p> <p>Des produits courants disponibles dans le commerce peuvent être utilisés pour un lavage désinfectant général.</p> <p>BOWA exclue toute responsabilité quant au nettoyage, à la stérilisation ou à l'utilisation non conformes ou inappropriés.</p> <p>Les produits sont certifiés selon la directive 93 / 42 / CEE</p>
---	---	--



Todos los instrumentos reutilizables se suministran en estado no estéril y deben ser esterilizados a 134 °C / 20 min.

Todos los productos desechables no son previstos para reutilización.

Para la desinfección superficial general pueden utilizarse productos comerciales corrientes.

BOWA no asume ningún tipo de responsabilidad por la limpieza, la esterilización y la utilización indebida.

Los productos están certificados según la norma 93 / 42 / CEE

Tutti gli strumenti riutilizzabili sono forniti non sterili e possono essere sterilizzati per 20 min a 134 °C.

Tutti i prodotti monouso sono destinati a non essere riutilizzati.

Per la pulizia e la disinfezione generale è possibile utilizzare i prodotti in commercio.

BOWA non si assume alcuna responsabilità per la pulizia, la sterilizzazione e l'uso non conforme.

I prodotti sono certificati in accordo con la norma 93 / 42 / CEE

9.1 Elektrochirurgie-Geräte
Electrosurgical units
Appareils d'électrochirurgie
Equipos de electrocirugía
Generatori elettrochirurgici



900-400

ARC 400

400 W CUT monopolar / bipolar
250 W monopolar / 350 W bipolar COAG
2 x monopolar – 3 x bipolar
MICRO
SimCOAG
GastroCut / Argon incl.
AUTOSTART
Touchscreen

Plug'n Cut COMFORT
LIGATION (option)
Bipolar Resection (option)
EASY
ISSys
ARC CONTROL
MetraLOOP®



900-351

ARC 350

350 W CUT monopolar / bipolar
250 W monopolar / 350 W bipolar
COAG
2 x monopolar – 2 x bipolar
MICRO
SimCOAG
AUTOSTART
Touchscreen

Plug'n Cut COMFORT
GastroCUT (option)
LIGATION (option)
Bipolar Resection (option)
EASY
ISSys
ARC CONTROL
MetraLOOP®



BOWA
A F C
4 0 0

BOWA
A F C
3 5 0

900-001	ARC PLUS	<p>ARC PLUS Argon-Koagulationsgerät für ARC 400 / ARC 350 (REF 900-351) ARC PLUS argon coagulation unit for ARC 400 / ARC 350 (REF 900-351) ARC PLUS Module de coagulation à l'Argon pour ARC 400 / ARC 350 (REF 900-351) ARC PLUS Equipo de coagulación con argón para ARC 400 / ARC 350 (REF 900-351) ARC PLUS Unità di coagulazione ad argon per ARC 400 / ARC 350 (REF 900-351)</p>
---------	----------	---

<p>ARC 400 / ARC 350 (REF 900-351) Option ARC 400 / ARC 350 (REF 900-351) option ARC 400 / ARC 350 (REF 900-351) option ARC 400 / ARC 350 (REF 900-351) opción ARC 400 / ARC 350 (REF 900-351) opzione</p>		
	900-395	<p>Option Bipolare Resektion für ARC 400 / ARC 350 (REF 900-351) Option Bipolar resection, for ARC 400 / ARC 350 (REF 900-351) Option Résection Bipolaire pour ARC 400 / ARC 350 (REF 900-351) Opción Resección bipolar para ARC 400 / ARC 350 (REF 900-351) Opzione Resezione bipolare per ARC 400 / ARC 350 (REF 900-351)</p>
	900-396	<p>Option LIGATION® für ARC 400 / ARC 350 (REF 900-351) Option LIGATION® for ARC 400 / ARC 350 (REF 900-351) Option LIGATION® pour ARC 400 / ARC 350 (REF 900-351) Opción LIGATION® para ARC 400 / ARC 350 (REF 900-351) Opzione LIGATION® per ARC 400 / ARC 350 (REF 900-351)</p>
	900-399	<p>Option Bipolar SimCoag für ARC 400 Option Bipolar SimCoag for ARC 400 Option Bipolar SimCoag pour ARC 400 Opción Bipolar SimCoag para ARC 400 Opzione Bipolar SimCoag per ARC 400</p>
	900-401	<p>Dr. Dongle® für ARC 400 Dr. Dongle® for ARC 400 Dr. Dongle® pour ARC 400 Dr. Dongle® para ARC 400 Dr. Dongle® per ARC 400</p>
	900-402	<p>USB Stick für ARC 400 USB flash drive for ARC 400 Clé USB pour ARC 400 Memoria USB para ARC 400 Chiave USB per ARC 400</p>
	900-391	<p>Option Argon / GastroCut, für ARC 350 (REF 900-351) Option Argon / GastroCut, for ARC 350 (REF 900-351) Option Argon / GastroCut, pour ARC 350 (REF 900-351) Opción Argon / GastroCut, para ARC 350 (REF 900-351) Opzione Argon / GastroCUT, per ARC 350 (REF 900-351)</p>

	<p>900-392</p>	<p>Optionale Erweiterung „Argon / GastroCut“ für ARC 250 / 303 Optional upgrade „Argon / GastroCut“ for ARC 250 / 303 Option „Argon / GastroCut“ pour ARC 250 / 303 Ampliación opcional „Argón / GastroCut“ para ARC 250 / 303 Estensione opzionale „Argon / GastroCut“ per ARC 250 / 303</p>
--	----------------	---

<p>ARC 303 Option Europa Option Europe Option Europe Opción Europa Opzione Europa</p>	<p>900-397</p>	<p>Die Option erlaubt den Betrieb von Erbe- und Martin-Handgriffen über einen Adapter. This option permits the operation of Erbe and Martin handles using an adapter. L'option permet le fonctionnement des manches Erbe et Martin via un adaptateur. La opción permite el funcionamiento de lápices Erbe y Martin mediante un adaptador. L'opzione consente l'azionamento di manipoli Erbe e Martin.</p> <p>inkl. Kurzbedienungsanleitung, Systemmeldungen incl. Basic guidelines, system information incl. Guide de démarrage rapide, messages système incl. Instrucciones básicas, informaciones del sistema incl. istruzioni d'uso in breve, informazioni di sistema</p> <p>Kabelhalter Cable holder Crochet porte-câble Portacables Portacavi</p>
--	----------------	--

oder / or / ou / o / o

<p>ARC 250 Option Europa Option Europe Option Europe Opción Europa Opzione Europa</p>	<p>900-398</p>	<p>Die Option erlaubt den Betrieb von Erbe- und Martin-Handgriffen über einen Adapter. This option permits the operation of Erbe and Martin handles using an adapter. L'option permet le fonctionnement des manches Erbe et Martin via un adaptateur. La opción permite el funcionamiento de lápices Erbe y Martin mediante un adaptador. L'opzione consente l'azionamento di manipoli Erbe e Martin.</p> <p>inkl. Kurzbedienungsanleitung, Systemmeldungen incl. Basic guidelines, system information incl. Guide de démarrage rapide, messages système incl. Instrucciones básicas, informaciones del sistema incl. istruzioni d'uso in breve, informazioni di sistema</p> <p>Kabelhalter Cable holder Crochet porte-câble Portacables Portacavi</p>
--	----------------	--

oder / or / ou / o / o

	<p>900-450</p>	<p>Kurzbedienungsanleitung, Systemmeldungen Basic guidelines, system information Guide de démarrage rapide, messages système Instrucciones básicas, informaciones del sistema Istruzioni d'uso in breve, informazioni di sistema ARC 250 / 303</p>
	<p>900-451</p>	<p>Kabelhalter für Cable holder for Crochet porte-câble Portacables para Portacavi per ARC 250 / 303</p>

9.1 Elektrochirurgie-Geräte
 Electrosurgical units
 Appareils d'électrochirurgie
 Equipos de electrocirugía
 Generatori elettrochirurgici



900-100	ARC 100	100 W CUT monopolar 100 W COAG 1 x monopolar – 1 x bipolar outlet	EASY ISSys
---------	---------	---	---------------

220-345		ARC 100 Jackknife 2,4 mm mit Kabel bipolare Pinzette 4 m ARC 100 Jackknife 2.4 mm with cable for bipolar forceps 4 m ARC 100 JackKNIFE 2,4 mm avec câble pour pince bipolaire 4 m ARC 100 JackKNIFE 2,4 mm con cable para pinza bipolar, longitud 4 m ARC 100 JackKNIFE 2,4 mm con cavo per pinza bipolare 4 m
---------	--	---



9.2 Fußschalter
Footswitch
Pédales de commande
Interruptor de pedal
Interruttori a pedale

IP X8, eintauchbar, explosionsgeschützt IP X8, immersion, explosion-protected IP X8, supportant une immersion, protégé contre explosions IP X8, protección contra inmersión y explosión IP X8, immergibile, antideflagrante		ARC 400 / 350	ARC 250 / 303	ARC 100
	901-032			
	901-031			
	901-021			
	901-022			
	901-011			
	901-012			

9.3 Kommunikations-Interface ARC – ARC PLUS
 Communication interface ARC – ARC PLUS
 Interface de communication ARC – ARC PLUS
 Interfaz de comunicación ARC – ARC PLUS
 Interfaccia di comunicazione ARC – ARC PLUS

		2 Lichtwellenleiter 2 Fibre optics 2 Câble en fibre optique 2 Cables de fibra optica 2 Cavi a fibre ottiche	
		901-051	ARC PLUS (900-001) 135 mm
		901-052	ARC PLUS (900-000) 175 mm

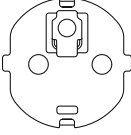
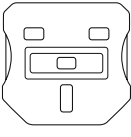
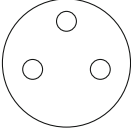
9.4 Netzkabel
 Mains cable
 Câble d'alimentation
 Cable de red
 Cavo di alimentazione

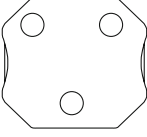
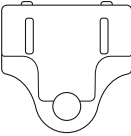
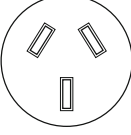
	<p>900-911</p>	<p>Netzkabel, Länge 5 m, mit Stecker Typ F Schuko Mains cable, length 5 m, with plug type F Schuko Câble d'alimentation, longueur 5 m, avec prise type F Schuko Cable de red, longitud 5 m con clavija tipo F Schuko Cavo di alimentazione, lunghezza 5 m, con spina tipo F schuko</p>
	<p>900-912</p>	<p>Netzkabel, Länge 5 m, mit Stecker Typ G Mains cable, length 5 m, with plug type G Câble d'alimentation, longueur 5 m, avec prise type G Cable de red, longitud 5 m con clavija tipo G Cavo di alimentazione, lunghezza 5 m, con spina tipo G</p>
	<p>900-913</p>	<p>Netzkabel, Länge 5 m, mit Stecker Typ K Mains cable, length 5 m, with plug type K Câble d'alimentation, longueur 5 m, avec prise type K Cable de red, longitud 5 m con clavija tipo K Cavo di alimentazione, lunghezza 5 m, con spina tipo K</p>
	<p>900-914</p>	<p>Netzkabel, Länge 5 m, mit Stecker Typ L Mains cable, length 5 m, with plug type L Câble d'alimentation, longueur 5 m, avec prise type L Cable de red, longitud 5 m con clavija tipo L Cavo di alimentazione, lunghezza 5 m, con spina tipo L</p>
	<p>900-915</p>	<p>Netzkabel, Länge 5 m, mit Stecker Typ N Mains cable, length 5 m, with plug type N Câble d'alimentation, longueur 5 m, avec prise type N Cable de red, longitud 5 m con clavija tipo N Cavo di alimentazione, lunghezza 5 m, con spina tipo N</p>
	<p>900-916</p>	<p>Netzkabel, Länge 5 m, mit Stecker Typ B Mains cable, length 5 m, with plug type B Câble d'alimentation, longueur 5 m, avec prise type B Cable de red, longitud 5 m con clavija tipo B Cavo di alimentazione, lunghezza 5 m, con spina tipo B</p>
	<p>900-917</p>	<p>Netzkabel, Länge 5 m, mit Stecker Typ I Mains cable, length 5 m, with plug type I Câble d'alimentation, longueur 5 m, avec prise type I Cable de red, longitud 5 m con clavija tipo I Cavo di alimentazione, lunghezza 5 m, con spina tipo I</p>

9.5 Potentialausgleichsleitung
 Equipotential bonding
 Câble équipotentiel
 Conductor equipotencial
 Conduttore equipotenziale

	900-031	Potentialausgleichsleitung, Länge 5 m PE-line, length 5 m Câble équipotentiel, longueur 5 m Conductor equipotencial, 5 m de largo Conduttore equipotenziale, lunghezza 5 m
	900-035	Potentialausgleichsleitung, Länge 1.5 m PE-line, length 1.5 m Câble équipotentiel, longueur 1.5 m Conductor equipotencial, 1.5 m de largo Conduttore equipotenziale, lunghezza 1.5 m
	900-030	Potentialausgleichsleitung, Länge 0.5 m PE-line, length 0.5 m Câble équipotentiel, longueur 0.5 m Conductor equipotencial, 0.5 m de largo Conduttore equipotenziale, lunghezza 0.5 m

9.6 Druckminderer für ARC PLUS REF 900-000
 Pressure reducer
 Manodétendeur
 Manorreductor
 Riduttore di pressione

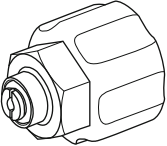
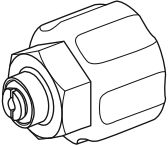
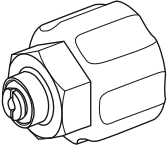
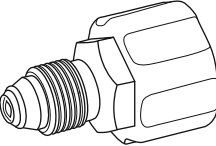
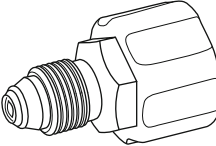
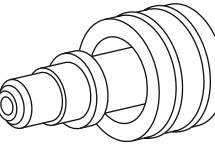

					
900-901	900-902	900-922	900-903	900-904	900-924
DIN 477, No. 6	DIN 477, No. 10	ГОСТ G 3/4"	CGA 580	BS 341, No. 3	ISO 5145, No. 4
Central Europe, Eastern Europe, Spain	Netherlands, Northern Europe	Commonwealth of Independent states (CIS)	America, Far East, Italy, UAE	Commonwealth, Turkey	Europe, France
W 21.8 x 1/14"	W 24.32 x 1/14"	ГОСТ G 3/4"	0.965"-14 NGO i (W 24.511 x 1/14" INT)	G 5/8" BSPF G 5/8" INT	W 24x2 RH Ø13.3/14.7

9.7 Druckminderer für ARC PLUS REF 900-001
 Pressure reducer
 Manodétendeur
 Manorreductor
 Riduttore di pressione

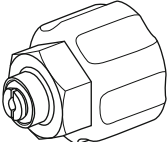
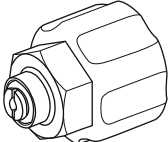
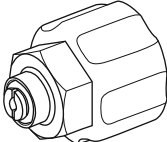
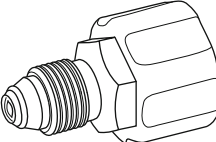
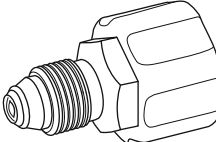
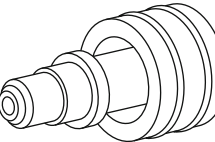

					
900-906	900-907	900-921	900-908	900-909	900-923
DIN 477, No. 6	DIN 477, No. 10	ГОСТ G 3/4"	CGA 580	BS 341, No. 3	ISO 5145, No. 4
Central Europe, Eastern Europe, Spain	Netherlands, Northern Europe	Commonwealth of Independent states (CIS)	America, Far East, Italy, UAE	Commonwealth, Turkey	Europe, France
W 21.8 x 1/14"	W 24.32 x 1/14"	ГОСТ G 3/4"	0.965"-14 NGO i (W 24.511 x 1/14" INT)	G 5/8" BSPF G 5/8" INT	W 24x2 RH Ø 13.3/14.7

9.8 Argon Gasflasche
 Gas cylinder Argon
 Bouteille de gaz, Argon
 Botella de gas argón
 Bombola gas argon



	900-806	<p>Gasflasche Argon, 5 l, Anschluss DIN477 Nr. 6, leer Gas cylinder Argon, 5 l, connection DIN477 no. 6, empty Bouteille de gaz, 5 l Argon, DIN477 n° 6, vide Botella de gas argón, 5 l, conexión DIN477 no. 6, vacía Bombola gas argon, 5 l, connessione DIN477 Nr. 6, vuota</p>
	900-807	<p>Gasflasche Argon, 5 l, Anschluss DIN477 Nr. 10, leer Gas cylinder Argon, 5 l, connection DIN477 no. 10, empty Bouteille de gaz, 5 l Argon, DIN477 n° 10, vide Botella de gas argón, 5 l, conexión DIN477 no. 10, vacía Bombola gas argon, 5 l, connessione DIN477 Nr. 10, vuota</p>
	900-808	<p>Gasflasche Argon, 5 l, Anschluss CGA Nr. 580, leer Gas cylinder Argon, 5 l, connection CGA no. 580, empty Bouteille de gaz, 5 l Argon, CGA n° 580, vide Botella de gas argón, 5 l; conexión CGA no. 580, vacía Bombola gas argon, 5 l; connessione CGA Nr. 580, vuota</p>
	900-809	<p>Gasflasche Argon, 5 l, Anschluss BS 341 Nr. 3, leer Gas cylinder Argon, 5 l, connection BS 341 no. 3, empty Bouteille de gaz, 5 l Argon, BS 341 n° 3, vide Botella de gas argón, 5 l, conexión BS 341 no. 3, vacía Bombola gas argon, 5 l, connessione BS 341 Nr. 3, vuota</p>

<p>10.1 Gerätewagen ARC CART 10.2 Optionen Vorderseite 10.3 Optionen Rückseite 10.4 Zubehör</p>	<p>10.1 Trolley ARC CART 10.2 Options front side 10.3 Options rear side 10.4 Accessories</p>	<p>10.1 Chariot ARC CART 10.2 Options face avant 10.3 Options face arrière 10.4 Accessoires</p>
<p>10.1 Carro ARC CART 10.2 Opciones parte delantera 10.3 Opciones parte trasera 10.4 Accesorios</p>	<p>10.1 Carrello ARC CART 10.2 Opzioni frontale 10.3 Opzioni retro 10.4 Accessori</p>	

<p>Alle wiederverwendbaren Instrumente werden im unsterilen Zustand angeliefert und können bei 134 °C / 20 min sterilisiert werden.</p> <p>Alle Einmalprodukte sind nicht für den mehrmaligen Gebrauch vorgesehen.</p> <p>Für die allgemeine Wischdesinfektion können handelsübliche Mittel verwendet werden.</p> <p>Für unsachgemäße Reinigung, Sterilisation und Anwendung kann seitens BOWA keine Haftung übernommen werden.</p> <p>Die Produkte tragen das CE Zeichen nach Richtlinie 93 / 42 / EWG</p>	<p>All reusable instruments are supplied in an unsterile state and can be sterilised at 134 °C for 20 min.</p> <p>All single-use products are not intended for multiple usage.</p> <p>Commercially available agents can be used for general wiping and disinfection.</p> <p>BOWA can accept no liability for improper cleaning, sterilisation and use.</p> <p>The products are certified according to 93 / 42 / EEC</p>	<p>Tous les instruments réutilisables sont livrés non stériles et peuvent être stérilisés à 134 °C / 20 min.</p> <p>Aucun produit à usage unique n'est destiné à être réutilisé.</p> <p>Des produits courants disponibles dans le commerce peuvent être utilisés pour un lavage désinfectant général.</p> <p>BOWA exclue toute responsabilité quant au nettoyage, à la stérilisation ou à l'utilisation non conformes ou inappropriés.</p> <p>Les produits sont certifiés selon la directive 93 / 42 / CEE</p>
---	---	--



Todos los instrumentos reutilizables se suministran en estado no estéril y deben ser esterilizados a 134 °C / 20 min.

Todos los productos desechables no son previstos para reutilización.

Para la desinfección superficial general pueden utilizarse productos comerciales corrientes.

BOWA no asume ningún tipo de responsabilidad por la limpieza, la esterilización y la utilización indebida.

Los productos están certificados según la norma 93 / 42 / CEE

Tutti gli strumenti riutilizzabili sono forniti non sterili e possono essere sterilizzati per 20 min a 134 °C.

Tutti i prodotti monouso sono destinati a non essere riutilizzati.

Per la pulizia e la disinfezione generale è possibile utilizzare i prodotti in commercio.

BOWA non si assume alcuna responsabilità per la pulizia, la sterilizzazione e l'uso non conforme.

I prodotti sono certificati in accordo con 93 / 42 / CEE

10.1 Gerätewagen ARC CART
Trolley ARC CART
Chariot ARC CART
Carro ARC CART
Carrello ARC CART

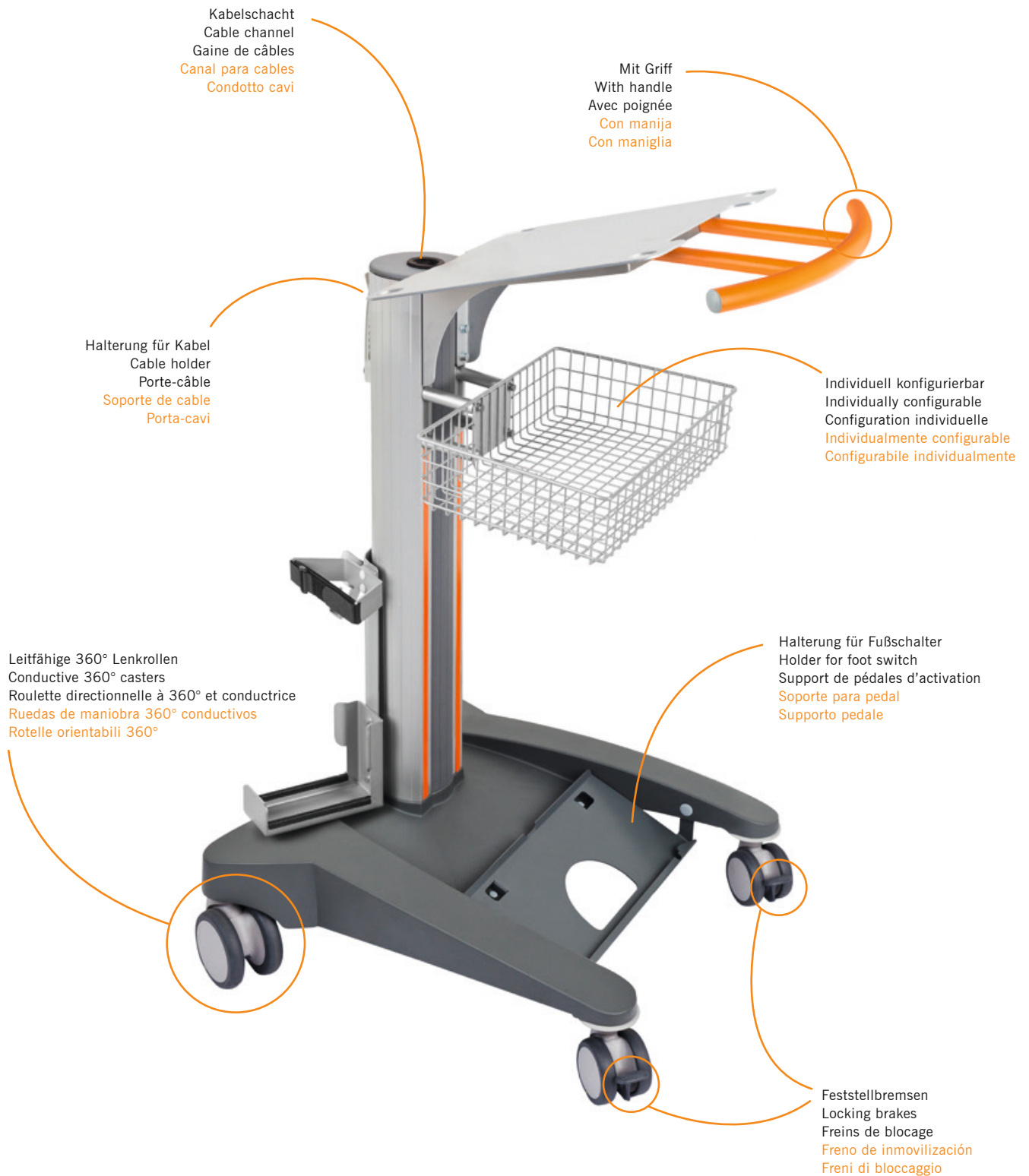

	<p>ARC CART</p> <p>mit Korb vorne, montiert with frontal basket, assembled avec panier, avant, monté cesta de frente, montado cestello, fissaggio anteriore, montato</p>	
	<p>902-050</p>	
	<p>inkl. / incl. / incl. / incl. / incl.</p>	
		<p>902-022</p>
		<p>902-912</p>
		<p>902-921</p>
		<p>902-917</p>
		<p>902-913</p>
		<p>902-911 (3 x)</p>
	<p>902-100</p>	

10.1 Gerätewagen ARC CART
 Trolley ARC CART
 Chariot ARC CART
 Carro ARC CART
 Carrello ARC CART

	902-053	ARC CART Gerätewagen mit Schublade, montiert Equipment trolley with drawer, assembled Chariot modulaire, avec tiroir, monté Carro porta equipo, con gaveta, montado Carrello con cassetto, montato
	inkl. / incl. / incl. / incl. / incl.	
		902-022
		902-921
		902-906
		902-909
		902-917
		902-914
		902-911 (3 x)
		902-100

	<p>ARC CART</p> <p>für SHE SHA, montiert for SHE SHA, assembled Chariot modulaire monté, pour SHE SHA Carro para SHE SHA, montado Carrello predisposto per SHE SHA, montato</p> <p>902-054</p>	
	<p>inkl. / incl. / incl. / incl. / incl.</p>	
		<p>902-022</p>
		<p>902-920</p>
		<p>902-912</p>
		<p>902-921</p>
		<p>902-917</p>
		<p>902-913</p>
		<p>902-911 (4 x)</p>
		<p>902-100</p>







10.1 Gerätewagen ARC CART
 Trolley ARC CART
 Chariot ARC CART
 Carro ARC CART
 Carrello ARC CART

	902-055	ARC CART Gerätewagen für SHE SHA und LOTUS, montiert Equipment trolley for SHE SHA and LOTUS, assembled Chariot modulaire monté, pour SHE SHA et LOTUS Carro para SheSha y LOTUS, montado Carrello per SHE SHA e LOTUS, montato
	inkl. / incl. / incl. / incl. / incl.	
		902-022
		902-924
		902-920
		902-921
		902-917
		902-913
		902-923
		902-911 (4 x)
	902-100	



902-056	<p>ARC CART</p> <p>Gerätewagen für LOTUS mit Korb vorne, montiert Equipment trolley for LOTUS with frontal basket, assembled Chariot modulaire pour LOTUS avec panier avant, monté Carro para LOTUS, montado, com cesta frontal Carrello per LOTUS, con cestello anteriore, montato</p>
inkl. / incl. / incl. / incl. / incl.	
	902-022
	902-924
	902-912
	902-921
	902-917
	902-923
	902-911 (4 x)
	902-100

10.1 Gerätewagen ARC CART
 Trolley ARC CART
 Chariot ARC CART
 Carro ARC CART
 Carrello ARC CART

	902-070	LOTUS CART Gerätewagen, montiert Equipment trolley, assembled Chariot modulaire monté Carro, montado Carrello, montato
	inkl. / incl. / incl. / incl. / incl.	
		902-024
		902-912
		902-921
		902-911 (4 x)
		902-100

10.2 Optionen Vorderseite
 Options front side
 Options face avant
 Opciones parte delantera
 Opzioni frontale

	<p>902-022</p>	<p>ARC CART, Gerätewagen ARC CART, equipment trolley ARC CART, chariot modulaire ARC CART, carro porta equipo ARC CART, carrello</p> <p style="text-align: right;"> <u>BOWA</u> <u>BOWA</u> ARC ARC 250 303 <u>BOWA</u> <u>BOWA</u> ARC ARC 350 400 </p>
	<p>902-920</p>	<p>Geneigter Stellboden, für SHE SHA (950-001) an ARC CART Angled equipment shelf, for SHE SHA (950-001), for ARC CART Support SHE SHA (950-001) pour ARC CART Repisa inclinada, para SHE SHA (950-001) para ARC CART Mensola inclinata, per SHE SHA (950-001) ad ARC CART</p>
	<p>902-924</p>	<p>Geneigter Stellboden, für LOTUS LG4 an ARC CART ARC CART, angled equipment shelf, for LOTUS LG4 ARC CART, support pour LOTUS LG4 ARC CART, repisa inclinada, for LOTUS LG4 Mensola inclinata, per Lotus LG4 ed ARC Cart</p>
<p>oder / or / ou / o / o</p>		
	<p>902-912</p>	<p>Ablagekorb, vorne, für ARC CART Filing basket, front side, for ARC CART Panier, avant, pour ARC CART Cesta de frente, para ARC CART Cestello, fissaggio anteriore, per ARC CART</p>
<p>oder / or / ou / o / o</p>		
	<p>902-906</p>	<p>Schublade mit Abdeckung, für ARC CART Drawer with cover, for ARC CART Tiroir et plateau supérieur, pour ARC CART Gaveta con tapa, para ARC CART Cassetto con coperchio, per ARC CART</p>
	<p>902-909</p>	<p>Zusatzschublade, für ARC CART Additional drawer, for ARC CART Tiroir supplémentaire, pour ARC CART Gaveta adicional, para ARC CART Cassetto addizionale, per ARC CART</p>
	<p>902-921</p>	<p>ARC CART, Griff ARC CART, handle ARC CART, poignée ARC CART, manija ARC CART, maniglia</p>

10.3 Optionen Rückseite
Options rear side
Options face arrière
Opciones parte trasera
Opzioni retro

	<p>902-900</p>	<p>Gasflaschenhalterung, für ARC CART Gas cylinder attachment, for ARC CART Support de bouteilles de gaz argon pour ARC CART Soporte para bombona de gas para ARC CART Supporto per bombola, per ARC CART</p>
---	----------------	---

oder / or / ou / o / o

	<p>902-908</p>	<p>Geschlossene Gasflaschenhalterung, für ARC CART Closed gas cylinder attachment, for ARC CART Support fermé de bouteilles de gaz argon, pour ARC CART Soporte cerrado para bombona de gas, para ARC CART Supporto per bombola, versione chiusa, per ARC CART</p>
---	----------------	--

oder / or / ou / o / o

	<p>902-913</p>	<p>Gasflaschenhalterung, für ARC CART Gas cylinder attachment, for ARC CART Support de bouteilles de gaz argon pour ARC CART Soporte para bombona de gas para ARC CART Supporto per bombola, per ARC CART</p>
---	----------------	---

oder / or / ou / o / o

	<p>902-914</p>	<p>Geschlossene Gasflaschenhalterung, für ARC CART Closed gas cylinder attachment, for ARC CART Support fermé de bouteilles de gaz argon, pour ARC CART Soporte cerrado para bombona de gas, para ARC CART Supporto per bombola, versione chiusa, per ARC CART</p>
---	----------------	--

oder / or / ou / o / o

	<p>902-917</p>	<p>Halterung für Einpedal Fußschalter Holder for single-pedal foot switch Support de pédale simple Soporte para pedal simple Supporto per pedale singolo</p>
---	----------------	--







	902-917	Halterung für Einpedal Fußschalter Holder for single-pedal foot switch Support de pédale simple Soporte para pedal simple Supporto per pedale singolo
	902-913	Gasflaschenhalterung, für ARC CART Gas cylinder attachment, for ARC CART Support de bouteilles de gaz argon pour ARC CART Soporte para bombona de gas para ARC CART Supporto per bombola, per ARC CART

oder / or / ou / o / o

	902-917	Halterung für Einpedal Fußschalter Holder for single-pedal foot switch Support de pédale simple Soporte para pedal simple Supporto per pedale singolo
	902-914	Geschlossene Gasflaschenhalterung, für ARC CART Closed gas cylinder attachment, for ARC CART Support fermé de bouteilles de gaz argon, pour ARC CART Soporte cerrado para bombona de gas, para ARC CART Supporto per bombola, versione chiusa, per ARC CART

	902-923	ARC CART, Griff Rückseite ARC CART, handle rear side ARC CART, poignée face arrière ARC CART, manija parte trasera ARC CART, maniglia posteriore
--	---------	--

10.4 Zubehör Accessories Accessoires Accesorios Accessori

	902-911	Anschluss Potentialausgleichsleitung Connector PE-line Connecteur équipotentiel Conector para cable equipotencial Connettore equipotenziale
	902-922	ARC CART, Sicherungskit ARC CART, Securing kit ARC CART, Kit de fixation ARC CART, Kit de Fijación ARC CART, Kit di protezione
	902-915	Ersatzband Gasflaschenhalter Replacement strap for gas cylinder attachment Sangle de rechange pour support de bouteille Banda de reserva para soporte de botella Fascia di ricambio per porta-bombola
	902-918	Kabel- und Fußschalter Halterung für Normschiene Cable and foot switch holder for standard rail Support de câble et de pédale pour rail normalisé Soporte para cable y pedal, para riel normalizado Porta-cavi e supporto pedale per guida
	902-919	Normschiene Standard rail Rail normalisé Riel normalizado Guida
	902-100	Montage ARC CART ARC CART assembly ARC CART, Forfait ARC CART montaje Assemblaggio ARC Cart

11 SHE SHA Rauchgasabsaugung
 SHE SHA Smoke Evacuation System
 SHE SHA Aspirateur de fumées
 SHE SHA Aspirador de humos quirúrgicos
 SHE SHA Aspiratore di fumi chirurgici

11.1 SHE SHA Rauchgasabsaugung 11.2 SHE SHA 11.3 Adapter Handgriffe 11.4 Zubehör SHE SHA REF 950-000	11.1 SHE SHA Smoke Evacuation System 11.2 SHE SHA 11.3 Adaptors handles 11.4 Accessories SHE SHA REF 950-000	11.1 SHE SHA Aspirateur de fumées 11.2 SHE SHA 11.3 Adaptateurs manches 11.4 Accessoires SHE SHA REF 950-000
11.1 SHE SHA Aspirador de humos quirúrgicos 11.2 SHE SHA 11.3 Adaptadores mangos 11.4 Accesorios SHE SHA REF 950-000	11.1 SHE SHA Aspiratore di fumi chirurgici 11.2 SHE SHA 11.3 Adattatori manipoli 11.4 Accessori SHE SHA REF 950-000	

<p>Alle wiederverwendbaren Instrumente werden im unsterilen Zustand angeliefert und können bei 134 °C / 20 min sterilisiert werden.</p> <p>Alle Einmalprodukte sind nicht für den mehrmaligen Gebrauch vorgesehen.</p> <p>Für die allgemeine Wischdesinfektion können handelsübliche Mittel verwendet werden.</p> <p>Für unsachgemäße Reinigung, Sterilisation und Anwendung kann seitens BOWA keine Haftung übernommen werden.</p> <p>Die Produkte tragen das CE Zeichen nach Richtlinie 93 / 42 / EWG</p>	<p>All reusable instruments are supplied in an unsterile state and can be sterilised at 134 °C for 20 min.</p> <p>All single-use products are not intended for multiple usage.</p> <p>Commercially available agents can be used for general wiping and disinfection.</p> <p>BOWA can accept no liability for improper cleaning, sterilisation and use.</p> <p>The products are certified according to 93 / 42 / EEC</p>	<p>Tous les instruments réutilisables sont livrés non stériles et peuvent être stérilisés à 134 °C / 20 min.</p> <p>Aucun produit à usage unique n'est destiné à être réutilisé.</p> <p>Des produits courants disponibles dans le commerce peuvent être utilisés pour un lavage désinfectant général.</p> <p>BOWA exclue toute responsabilité quant au nettoyage, à la stérilisation ou à l'utilisation non conformes ou inappropriés.</p> <p>Les produits sont certifiés selon la directive 93 / 42 / CEE</p>
---	---	--



Todos los instrumentos reutilizables se suministran en estado no estéril y deben ser esterilizados a 134 °C / 20 min.

Todos los productos desechables no son previstos para reutilización.

Para la desinfección superficial general pueden utilizarse productos comerciales corrientes.

BOWA no asume ningún tipo de responsabilidad por la limpieza, la esterilización y la utilización indebida.

Los productos están certificados según la norma 93 / 42 / CEE

Tutti gli strumenti riutilizzabili sono forniti non sterili e possono essere sterilizzati per 20 min a 134 °C.

Tutti i prodotti monouso sono destinati a non essere riutilizzati.

Per la pulizia e la disinfezione generale è possibile utilizzare i prodotti in commercio.

BOWA non si assume alcuna responsabilità per la pulizia, la sterilizzazione e l'uso non conforme.

I prodotti sono certificati in accordo con 93 / 42 / CEE

11.1 SHE SHA Rauchgasabsaugung
 SHE SHA Smoke Evacuation System
 SHE SHA Aspirateur de fumées
 SHE SHA Aspirador de humos quirúrgicos
 SHE SHA Aspiratore di fumi chirurgici



Effizienter Gesundheitsschutz – Leise
 Efficient health protection – Quiet
 Protection efficace de la santé – Silencieux
 Protección eficiente de la salud – Silencioso
 Efficiente tutela della salute – Silenzioso

Automatische Aktivierung über Sensor mit allen elektrochirurgischen Geräten
 Automatic activation combinable with all devices
 Activation automatique via capteur d'activation avec tous les appareils électrochirurgicaux
 Activación automática por sensor con todos los equipos quirúrgicos
 Attivazione automatica tramite sensore con tutti gli strumenti elettrochirurgici

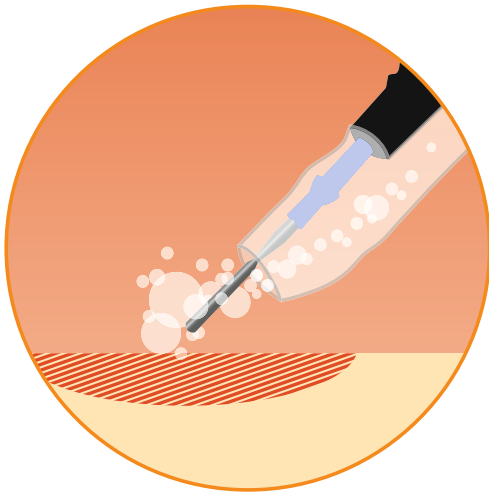

99.999% Filtereffizienz
 99.999% filter efficiency
 99.999% efficacité du filtre
 99.999% eficiencia del filtro
 99.999% efficienza del filtro

3 Leistungsstufen
 3 power levels
 3 niveaux de puissance
 3 niveles de potencia
 3 livelli di potenza

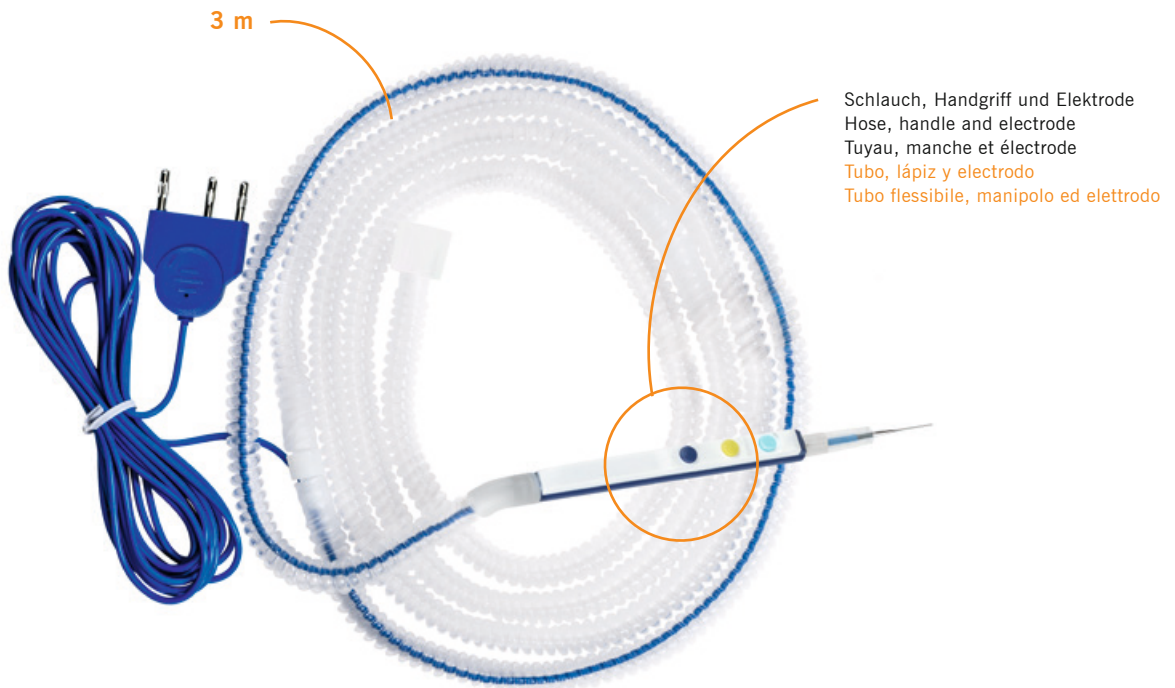

3 m

Schlauch, Handgriff und Elektrode
 Hose, handle and electrode
 Tuyau, manche et électrode
 Tubo, lápiz y electrodo
 Tubo flessibile, manipoled ed elettrodo

Max. 55 db (Gesprächslautstärke)
 Max. 55 db (voice volume)
 55 db max. (volume d'une conversation)
 Máx. 55 db (ruido de conversación)
 Max. 55 db (volume di conversazione)

Automatische Filtererkennung Plug'n Play
 Automatic plug'n play filter recognition
 Plug'n Play identification automatique du filtre
 Identificación automática del filtro por plug'n play
 Riconoscimento automatico del filtro Plug'n Play



Extra lange Filterlebensdauer für max. 35 Stunden Aktivierung
 Extra-long filter life for max. 35 hours of activation
 Grande longévité du filtre pour une activation de 35h max.
 Duración del filtro extralarga para máx. 35 horas de activación
 Extra-durata del filtro per max 35 ore di attivazione

3-Port-Filter mit Berührungsschutz
 3-port filter with protection against accidental contact
 Filtre 3 ports avec protection anti-contact
 Filtro de 3 puertos con protección contra el contacto
 Filtro a 3 porte con protezione anti-contatto

1/4"
[8,4 mm]



3/8"
[9,5 mm]

7/8"
[22 mm]

11.2 SHE SHA

	<p>950-001</p>	<p>SHE SHA Rauchgasabsaugung inkl. Aktivierungssensor, pneumatischem Fußschalter SHE SHA smoke evacuation system incl. remote sensor and pneumatic foot switch Aspirateur de fumées SHE SHA sonde d'activation et pédale pneumatique incl. SHE SHA Aspirador de humos quirúrgicos incl. sensor de activación y pedal neumático SHE SHA Aspiratore di fumi chirurgici incl. sensore di attivazione, comando pneumatico a pedale</p> <p>Ohne Filter Without filter Sans filtre Sin filtro Senza filtro</p>
	<p>951-001</p>	<p>SHE SHA (950-001) Filter für 35 Stunden / 2 Stk. SHE SHA (950-001) filter for 35 hours / 2 pcs. Filtre SHE SHA (950-001) pour 35 heures / 2 unités Filtro SHE SHA (950-001) para 35 horas / 2 uds. Filtro SHE SHA (950-001) per 35 ore / 2 pz.</p>

11.3 Adapter Handgriffe Adaptors handles Adaptateurs manches Adaptadores mangos Adattatori manipoli

	<p>802-033</p>	<p>SHE SHA Handgriff, längenverstellbar, 2 Tasten, Messer, 3 m, Einweg, steril (10 Stk.) inkl. Holster SHE SHA handle, adjustable length, 2 buttons, knife electrode, 3 m, single-use, sterile (10 pcs.) incl. holster Manche SHE SHA, réglable en longueur, 2 boutons, couteau, 3 m, usage unique, stérile (10 unités), étui incl. Lápiz SHE SHA, ajustable en longitud, 2 botones, cuchilla, 3 m, desechable, esterilizado (10 uds.) incl. funda Manipolo SHE SHA, regolabile in lunghezza, 2 tasti, bisturi, 3 m, monouso, sterile (10 pz.) incl. custodia</p>
	<p>802-032</p>	<p>SHE SHA Handgriff, 2 Tasten, Messer, 3 m, Einweg, steril / 10 Stk. / inkl. Holster SHE SHA handle, 2 buttons, knife electrode, 3 m, single-use, sterile / 10 pcs. / incl. holster Manche SHE SHA, 2 boutons, couteau, 3 m, usage unique, stérile / 10 unités / étui incl. Lápiz SHE SHA, 2 botones, cuchilla, 3 m, desechable, esterilizado / 10 uds. / incl. funda Manipolo SHE SHA, 2 tasti, bisturi, 3 m, monouso, sterile / 10 pz. / incl. custodia</p>
	<p>952-001</p>	<p>SHE SHA Schlauch, für Handgriff, 3 m, Einweg, steril / 10 Stk. SHE SHA hose for handle, 3 m, single-use, sterile / 10 pcs. Tuyau SHE SHA, pour le manche, 3 m, usage unique, stérile / 10 unités Tubo SHE SHA, para lápiz, 3 m, desechable, esterilizado / 10 uds. Tubo flessibile SHE SHA, per manipolo, 3 m, monouso, sterile / 10 pz.</p>



11.3 Adapter Handgriffe
 Adaptors handles
 Adaptateurs manches
 Adaptadores mangos
 Adattatori manipoli



STERILE

R

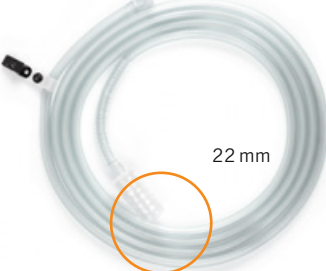

 <p>Powered By BUFFALO Filter®</p> <p>Schlauch 7/8" (22 mm) Tubing 7/8" (22 mm) Tuyau d'aspiration 7/8" (22 mm) Manguera 7/8" (22 mm) Tubazione 7/8" (22 mm)</p>	952-000	Schlauch für Handgriff SHE SHA / 10 Stk. / 3 m Hose for pencil SHE SHA / 10 pcs. / 3 m Tuyau pour manches SHE SHA / 10 pcs. / 3 m Manguera para mangos SHE SHA / 10 uds. / 3 m Tubo per manipolo SHE SHA / 10 pz. / 3 m Für / For / Pour / Para / Per 801-030; 802-030; 322-045; 110-045; 112-045; 227-045; 327-045; 220-145; 220-045; 120-145; 120-045; 220-245	
	952-100	Schlauch für Handgriff SHE SHA, klein / 10 Stk. / 3 m Hose for pencil SHE SHA, small / 10 pcs. / 3 m Tuyau pour manches SHE SHA, petit / 10 pcs. / 3 m Manguera para mangos SHE SHA, delgado / 10 uds. / 3 m Tubo per manipolo SHE SHA, sottile / 10 pz. / 3 m Für / For / Pour / Para / Per 215-045; 104-045; 214-045; 218-045; 105-045; 330-030; 100-016; 210-030; 219-030; 335-030	

 <p>22 mm</p>	952-200	Schlauch SHE SHA für Laparoskopie mit Luer Lock / 3 m Hose SHE SHA for laparoscopy with Luer Lock / 3 m Tuyau SHE SHA pour laparoscopie avec Luer Lock / 3 m Manguera SHE SHA para laparoscopia con Luer Lock / 3 m Tubo SHE SHA per laparoscopia con Luer Lock / 3 m
---	---------	---

11.4 Zubehör SHE SHA REF 950-000
 Accessories SHE SHA REF 950-000
 Accessoires SHE SHA REF 950-000
 Acessorios SHE SHA REF 950-000
 Accessori SHE SHA REF 950-000

 <p>Powered By BUFFALO Filter®</p>	951-000	Filter SHE SHA (950-000) 8 Stunden – 7/8" (22 mm) Filter SHE SHA (950-000) 8 hours – 7/8" (22 mm) Filtre SHE SHA (950-000) 8 heures – 7/8" (22 mm) Filtro SHE SHA (950-000) 8 horas – 7/8" (22 mm) Filtro SHE SHA (950-000) 8 ore – 7/8" (22 mm)
	952-300	Vorfilter SHE SHA (950-000) Pre-filter SHE SHA (950-000) Pré-filtre SHE SHA (950-000) Prefiltro SHE SHA (950-000) Prefiltro SHE SHA (950-000)

12 Set Empfehlungen
Set recommendations
Set recommandations
Set recomendaciones
Set raccomandazioni

12.1 Zubehör Set	12.1 Accessories set	12.1 Set d'accessoires
12.2 ARC 100 Komplettsset	12.2 ARC 100 Complete set	12.2 ARC 100 Kit complet
12.3 NightKNIFE® & LIGATOR® Set	12.3 NightKNIFE® & LIGATOR® Set	12.3 NightKNIFE® & LIGATOR® Set
12.4 Set Chirurgie	12.4 Set Surgery	12.4 Set Chirurgie
12.5 Set Argon Chirurgie	12.5 Set Argon Surgery	12.5 Set Chirurgie à l'argon
12.6 Set Gynäkologie	12.6 Set Gynaecology	12.6 Set Gynécologie
12.7 Set Urologie	12.7 Set Urology	12.7 Set Urologie
12.8 Set Gastroenterologie	12.8 Set Gastroenterology	12.8 Set Gastroentérologie
12.9 Set Herzchirurgie	12.9 Set Cardiac Surgery	12.9 Set Chirurgie cardiaque
12.10 Set Orthopädie	12.10 Set Orthopedics	12.10 Set Orthopédie
12.11 Set Kinderchirurgie	12.11 Set Pediatric Surgery	12.11 Set Chirurgie pédiatrique
12.12 Set Neurochirurgie	12.12 Set Neuro Surgery	12.12 Set Neurochirurgie
12.13 Set Plastische und Ästhetische Chirurgie	12.13 Set Plastic and Aesthetic Surgery	12.13 Set Chirurgie plastique et esthétique
12.1 Set accesorios	12.1 Set accessori	
12.2 ARC 100 Juego completo	12.2 ARC 100 Set completo	
12.3 NightKNIFE® & LIGATOR® Set	12.3 NightKNIFE® & LIGATOR® Set	
12.4 Set Cirugía	12.4 Set Chirurgia	
12.5 Set Cirugía argón	12.5 Set Chirurgia argon	
12.6 Set Ginecología	12.6 Set Ginecologia	
12.7 Set Urología	12.7 Set Urologia	
12.8 Set Gastroenterología	12.8 Set Gastroenterologia	
12.9 Set Cirugía cardiovascular	12.9 Set Cardiochirurgia	
12.10 Set Ortopedia	12.10 Set Ortopedia	
12.11 Set Cirugía pediátrica	12.11 Set Chirurgia Pediatrica	
12.12 Set Neurocirugía	12.12 Set Neurochirurgia	
12.13 Set Cirugía estética y plástica	12.13 Set Chirurgia Plastica ed Estetica	

<p>Alle wiederverwendbaren Instrumente werden im unsterilen Zustand angeliefert und können bei 134 °C / 20 min sterilisiert werden.</p> <p>Alle Einmalprodukte sind nicht für den mehrmaligen Gebrauch vorgesehen.</p> <p>Für die allgemeine Wischdesinfektion können handelsübliche Mittel verwendet werden.</p> <p>Für unsachgemäße Reinigung, Sterilisation und Anwendung kann seitens BOWA keine Haftung übernommen werden.</p> <p>Die Produkte tragen das CE Zeichen nach Richtlinie 93 / 42 / EWG</p>	<p>All reusable instruments are supplied in an unsterile state and can be sterilised at 134 °C for 20 min.</p> <p>All single-use products are not intended for multiple usage.</p> <p>Commercially available agents can be used for general wiping and disinfection.</p> <p>BOWA can accept no liability for improper cleaning, sterilisation and use.</p> <p>The products are certified according to 93 / 42 / EEC</p>	<p>Tous les instruments réutilisables sont livrés non stériles et peuvent être stérilisés à 134 °C / 20 min.</p> <p>Aucun produit à usage unique n'est destiné à être réutilisé.</p> <p>Des produits courants disponibles dans le commerce peuvent être utilisés pour un lavage désinfectant général.</p> <p>BOWA exclue toute responsabilité quant au nettoyage, à la stérilisation ou à l'utilisation non conformes ou inappropriés.</p> <p>Les produits sont certifiés selon la directive 93 / 42 / CEE</p>
---	---	--



Todos los instrumentos reutilizables se suministran en estado no estéril y deben ser esterilizados a 134 °C / 20 min.

Todos los productos desechables no son previstos para reutilización.

Para la desinfección superficial general pueden utilizarse productos comerciales corrientes.

BOWA no asume ningún tipo de responsabilidad por la limpieza, la esterilización y la utilización indebida.

Los productos están certificados según la norma 93 / 42 / CEE

Tutti gli strumenti riutilizzabili sono forniti non sterili e possono essere sterilizzati per 20 min a 134 °C.

Tutti i prodotti monouso sono destinati a non essere riutilizzati.







Per la pulizia e la disinfezione generale è possibile utilizzare i prodotti in commercio.

BOWA non si assume alcuna responsabilità per la pulizia, la sterilizzazione e l'uso non conforme.

I prodotti sono certificati in accordance con 93 / 42 / CEE

12.1 Zubehör-Set
Accessories set
Set d'accessoires
Set accesorios
Set accessori



	901-140 SET Ø 4 mm	901-124 SET Ø 2.4 mm
	500-000	530-000
	215-045	218-045
	333-001	333-001
	816-112	816-112
	380-050	380-050
	605-040	605-040
	351-040	351-040





12.2 ARC 100 Komplettsset
Complete set
Kit complet
Juego completo
Set completo





	901-126
	530-000
	220-045
	816-072
	386-050
	605-040
	287-040
	901-012

Optionales Zubehör
 Optional accessories
 Accessoires en option
 Accesorios opcionales
 Accessori opzionali

	220-345
	385-050
	232-003
	194-075

12.3 NightKNIFE® & LIGATOR® Set – Container & Tray



773-000

773-001



773-981

773-981



773-980

773-980



770-000

770-000



770-320

770-320

770-336

770-336



771-120

771-121

771-136

771-137



773-000

773-001



770-999



770-211

770-211

770-236

770-236



771-011

771-011

771-036

771-036



772-011

772-011

772-036

772-036

12.4 Set Chirurgie
Surgery
Chirurgie
Cirugía
Chirurgia













	BASIS BASIC GÉNÉRAL BÁSICO GENERALE	FORTGESCHRITTEN (OFFEN) ADVANCED (OPEN) AVANÇÉ (OUVERTE) AVANZADO (ABIERTO) AVANZATA (OPEN)
	900-303	900-400
		900-396
	901-021	901-032
		901-011
	220-045	220-045
	530-207	530-207
		530-000
	380-050	380-050
	816-092	816-092
	351-040	351-040
	605-040	605-040
	605-034	605-002
		378-045
		797-230
		760-216
		760-219
		760-223
		760-228





	BASIS (LAPAROSKOPIE) BASIC (LAPAROSCOPY) GÉNÉRAL (LAPAROSCOPIQUE) BÁSICO (LAPAROSCOPIA) GENERALE (LAPAROSCOPIA)	FORTGESCHRITTEN (LAPAROSKOPIE) ADVANCED (LAPAROSCOPY) AVANCÉ (LAPAROSCOPIQUE) AVANZADO (LAPAROSCOPIA) AVANZATA (LAPAROSCOPIA)
	900-303	900-400
		900-396
	901-021	901-031
		901-011
	220-045	220-045
	530-207	530-207
		530-000
	380-050	380-050
	816-092	816-092
	280-050	280-050
	700-005	700-004
	280-035	700-005
		280-035
		351-040
		605-040
		770-503
		775-000

12.5 Set Argon Chirurgie
 Argon Surgery
 Chirurgie à l'argon
 Cirugía argón
 Chirurgia argon



	BASIS BASIC GÉNÉRAL BÁSICO GENERALE	FORTGESCHRITTEN ADVANCED AVANÇÉ AVANZADO AVANZATA
	900-303	900-400
	900-392	900-396
	900-000	900-001
	900-90x	900-90x
	902-022	902-022
		902-912
	902-913	902-913
		901-011
	901-031	901-032
	380-050	380-050
	816-092	816-092
	220-045	220-045
	530-207	530-207
	351-040	351-040
	605-040	605-040
	605-034	605-034
	830-050	830-050











	BASIS BASIC GÉNÉRAL BÁSICO GENERALE	FORTGESCHRITTEN ADVANCED AVANÇÉ AVANZADO AVANZATA
	932-042	932-042
	932-031	932-031
		932-032
	932-034	932-034
		932-058
		932-059
		932-036
		932-061
		760-223

12.6 Set Gynäkologie
Gynaecology
Gynécologie
Ginecología
Ginecologia



	BASIS BASIC GÉNÉRAL BÁSICO GENERALE	FORTGESCHRITTEN (OFFEN) ADVANCED (OPEN) AVANÇÉ (OUVERTE) AVANZADO (ABIERTO) AVANZATA (OPEN)	FORTGESCHRITTEN (LAPAROSKOPIE) ADVANCED (LAPAROSCOPY) AVANÇÉ (LAPAROSCOPIQUE) AVANZADO (LAPAROSCOPIA) AVANZATA (LAPAROSCOPIA)
	900-303	900-400	900-400
		900-396	900-396
		900-395	900-395
	901-031	901-032	901-032
		901-011	901-011
	380-050	380-050	380-050
	816-092	816-092	816-092
	220-045	220-045	
	530-207		
		530-000	
	351-040	351-040	
	605-040	605-040	
		605-002	









	BASIS BASIC GÉNÉRAL BÁSICO GENERALE	FORTGESCHRITTEN (OFFEN) ADVANCED (OPEN) AVANÇÉ (OUVERTE) AVANZADO (ABIERTO) AVANZATA (OPEN)	FORTGESCHRITTEN (LAPAROSKOPIE) ADVANCED (LAPAROSCOPY) AVANÇÉ (LAPAROSCOPIQUE) AVANZADO (LAPAROSCOPIA) AVANZATA (LAPAROSCOPIA)
		797-230	
		378-045	
		760-219	
		760-223	
		760-228	
			700-005
			280-035
			520-115
			770-503
			775-000

12.7 Set Urologie
 Urology
 Urologie
 Urología
 Urologia









	FORTGESCHRITTEN (OFFEN) ADVANCED (OPEN) AVANCÉ (OUVERTE) AVANZADO (ABIERTO) AVANZATA (OPEN)	FORTGESCHRITTEN (ARGON) ADVANCED (ARGON) AVANCÉ (ARGON) AVANZADO (ARGON) AVANZATA (ARGON)
	900-400	900-400
	900-396	900-396
	900-395	900-395
		900-001
		900-90x
		902-022
		902-912
		902-913
		902-917
	901-011	901-011
	901-031	901-031
	380-050	380-050
	816-092	816-092
	220-045	220-045
	530-000	530-000
	351-040	351-040
	605-040	605-040
	605-002	605-002



	FORTGESCHRITTEN (OFFEN) ADVANCED (OPEN) AVANÇÉ (OUVERTE) AVANZADO (ABIERTO) AVANZATA (OPEN)	FORTGESCHRITTEN (ARGON) ADVANCED (ARGON) AVANÇÉ (ARGON) AVANZADO (ARGON) AVANZATA (ARGON)
	798-230	798-230
	378-045	378-045
		830-050
		932-042
		932-031
		932-034
	760-223	760-223
		775-000

12.7 Set Urologie
 Urology
 Urologie
 Urología
 Urologia



	BASIS (MONOPOLARE RESEKTION) BASIC (MONOPOLAR RESECTION) GÉNÉRAL (RÉSECTION MONOPOLAIRE) BÁSICO (RESECCIÓN MONOPOLAR) GENERALE (RESEZIONE MONOPOLARE)	FORTGESCHRITTEN (BIPOLARE RESEKTION) ADVANCED (BIPOLAR RESECTION) AVANCÉ (RÉSECTION BIPOLAIRE) AVANZADO (RESECCIÓN BIPOLAR) AVANZATA (RESEZIONE BIPOLARE)
	900-303	900-400
		900-395
	901-021	901-032
	380-050	380-050
	816-092	816-092
	351-040	351-040
	605-040	605-040
	106-x45	35x-145









12.8 Set Gastroenterologie
 Gastroenterology
 Gastroentérologie
 Gastroenterología
 Gastroenterologia



	BASIS BASIC GÉNÉRAL BÁSICO GENERALE	FORTGESCHRITTEN ADVANCED AVANÇÉ AVANZADO AVANZATA
	900-250	900-400
	900-392	
	900-000	900-001
	900-90x	900-90x
	902-022	902-022
	902-906	902-906
	902-909	902-909
	902-913	902-913
	901-021	901-032
	380-050	380-050
	816-092	816-092
	431-045	431-045
	432-045	432-045
	830-050	830-050
	932-146	932-146
	932-249	932-249
		932-252
		932-253

12.9 Set Herzchirurgie
 Cardiac Surgery
 Chirurgie cardiaque
 Cirugía cardiovascular
 Cardiochirurgia



	BASIS BASIC GÉNÉRAL BÁSICO GENERALE	FORTGESCHRITTEN ADVANCED AVANÇÉ AVANZADO AVANZATA
	900-303	900-400
	901-031	901-032
		901-011
	380-050	380-050
	816-092	816-092
	220-045	220-045
	530-207	530-207
	351-040	351-040
	605-040	605-040







12.10 Set Orthopädie
 Orthopedics
 Orthopédie
 Ortopedia
 Ortopedia









	BASIS BASIC GÉNÉRAL BÁSICO GENERALE	FORTGESCHRITTEN ADVANCED AVANCÉ AVANZADO AVANZATA
	900-303	900-400
	901-031	901-032
	380-050	380-050
	816-092	816-092
	220-045	220-045
	530-000	530-000
	351-040	351-040
	605-040	605-040

12.11 Set Kinderchirurgie
 Pediatric Surgery
 Chirurgie pédiatrique
 Cirugía pediátrica
 Chirurgia Pediatrica







	FORTGESCHRITTEN ADVANCED AVANÇÉ AVANZADO AVANZATA
	900-400
	900-396
	900-001
	900-90x
	901-032
	380-050
	816-092
	220-045
	530-207
	530-211



	FORTGESCHRITTEN ADVANCED AVANÇÉ AVANZADO AVANZATA
	798-180
	378-045
	760-216
	830-050
	932-042
	932-032
	932-034











12.12 Set Neurochirurgie
 Neuro Surgery
 Neurochirurgie
 Neurocirugía
 Neurochirurgia

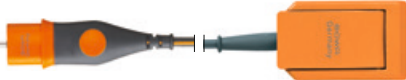

	FORTGESCHRITTEN ADVANCED AVANÇÉ AVANZADO AVANZATA
	900-400
	901-032
	901-011
	380-050
	816-092
	220-045
	530-207
	530-211
	351-040
	607-002
	607-014
	607-020
	607-027
	607-039

12.13 Set Plastische und Ästhetische Chirurgie
 Plastic and Aesthetic Surgery
 Chirurgie plastique et esthétique
 Cirugía estética y plástica
 Chirurgia Plastica ed Estetica



	FORTGESCHRITTEN ADVANCED AVANCÉ AVANZADO AVANZATA
	900-303
	901-031
	380-050
	816-092
	220-045
	530-207
	351-040
	607-002
	607-014
	607-020
	607-027
	607-039

Produktbeschreibung Product Description Désignation Descripción Descrizione	Autoklavierzyklen Autoclaving cycles Cycle autoclave Ciclos en autoclave Cicli in autoclave	Beispiel Example Exemple Ejemplo Esempio	Produktbeschreibung Product Description Désignation Descripción Descrizione	Autoklavierzyklen Autoclaving cycles Cycle autoclave Ciclos en autoclave Cicli in autoclave	Beispiel Example Exemple Ejemplo Esempio
ErgoPEN	200	110-045 215-045	Kabel – bipolare Resektion Cable – Bipolar resection Câble – Résection Bipolaire Cable – Resección bipolar Cavo – Resezione bipolare ERGO 315R	20	352-145 770-503
ErgoPEN COMFORT	100	215-145 218-145	Kabel – bipolare Resektion Cable – Bipolar resection Câble – Résection Bipolaire Cable – Resección bipolar Cavo – Resezione bipolare	50	354-145 355-145
Handgriffe JackKNIFE® Handles JackKNIFE® Manche JackKNIFE® Mango JackKNIFE® Manipolo JackKNIFE®	200	220-145	COMFORT Anschlusskabel Connecting cables Câbles de raccordement Cables de conexión Cavi di collegamento	100	352-145
Handgriffe ohne Schalter Handles without switch Manche sans boutons Mango sin pulsador Manipolo senza tasti	200	330-030 335-030	ErgoLAP Instrumente ErgoLAP Instruments ErgoLAP Instruments ErgoLAP Instrumentos ErgoLAP Strumenti	200	736-005 750-033
Elektroden Electrodes Electrodes Electrodos Elettrodi	75	530-207 500-000 510-108	ErgoLAP Mauleinsätze ErgoLAP Jaw inserts ErgoLAP Mâchoires ErgoLAP insertos (pinzas) ErgoLAP inserti	75	721-301 751-033
Elektroden mit isoliertem Schaft Electrodes with insulated shaft Electrodes avec tige isolée Electrodos con asta aislada Elettrodi con asta isolata	75	530-134 520-028	LAP Elektroden LAP Electrodes LAP Electrodes LAP Electrodes LAP Elettrodi	75	700-003 700-005
Anschlusskabel Connecting cables Câbles de raccordement Cables de conexión Cavi di collegamento	300	360-050 351-040	Monopolare Pinzetten Monopolar forceps Pincés monopolaires Pinzas monopolares Pinze monopolari	75	610-017 610-025

Produktbeschreibung Product Description Désignation Descripción Descrizione	Autoklavierzyklen Autoclaving cycles Cycle autoclave Ciclos en autoclave Cicli in autoclave	Beispiel Example Exemple Ejemplo Esempio	Produktbeschreibung Product Description Désignation Descripción Descrizione	Autoklavierzyklen Autoclaving cycles Cycle autoclave Ciclos en autoclave Cicli in autoclave	Beispiel Example Exemple Ejemplo Esempio
Bipolare Pinzetten Bipolar forceps Pincés bipolaires Pinzas bipolares Pinze bipolari	75	605-040 607-040	Argon-Handgriff Electrode handle for Argon-enhanced electrosurgery Manche Argon Mango para argón Manipolo Argon	100	932-042
BiZZER® Bipolare Schere Bipolar scissors Ciseaux bipolaires Tijeras bipolares Forbici bipolari	25	797-180 797-580	Starre Argonsonden Rigid Argon probes Electrodes Argon Electrodos rígidos para argón Elettrodi Argon	75	932-031
NightKNIFE® / LIGATOR® Handgriff Handle Manche Mango Impugnatura	100	770-000	Flexible Argonsonden Flexible Argon probes Sondes flexibles argon Sondas de argón flexibles Sonde flessibili ad argon	20	932-149
NightKNIFE® / LIGATOR® Schaftröhr Shaft tube Conduit Tubo Asta tubolare	200	770-236 770-336	Argon-Koagulationselektrode, biegbar Argon coagulation electrode, bendable Électrode de coagulation à l'argon, pliable Electrodo de coagulación con argón, flexible Elettrodo curvabile per argon	25	932-060 932-061 932-062
NightKNIFE® / LIGATOR® Mauleinsätze Jaw inserts Mâchoire de pince Insertos (pinzas) Branche della pinza	20	771-036	Anschlusskabel für flexible Argonsonden Connecting cable for flexible Argon probes Câble de raccordement pour sondes flexibles argon Cable de conexión para sondas de argón flexibles Cavo di collegamento per sonde flessibili ad argon	100	932-146
TissueSeal® PLUS TissueSeal® PLUS COMFORT MetraLOOP® MetraLOOP® COMFORT	50	520-113 760-223	Gummi-Neutralelektroden Rubber return patient plates Electrodes neutres réutilisables Electrodos neutros reutilizables Piastré di gomma riutilizzabili	75	242-003 232-003
TissueSeal® PLUS	50	760-223	Adapter Adaptors Adaptateurs Adaptadores Adattatori	75	111-001 340-000

Kurzübersicht Index Index Indice Indice

050-230	43	378-145	35/103	530-150	19	610-017	95/204	770-000	116/186/205	818-092	138	902-909	166/171/197
050-240	4	378-245	35/103	530-207	15/20/188	610-018	95	770-036	118	818-112	138	902-911	165/166/167
050-241	4	380-050	144/183/188		/189/190/192	610-019	95	770-200	116	818-141	141		/168/169/170
050-242	4		/189/190/192		/198/200/202	610-021	95	770-201	116	818-161	140		/173
100-016	11/179		/194/196/197		/203/204	610-025	95	770-211	118/187	818-162	140	902-912	165/167/169
101-000	35		/198/199/200	530-211	16/20/200	612-018	97	770-236	118/187/205	830-050	133/190/195		/170/171/190
101-003	145		/202/203		/202	612-021	97	770-300	116		/197/201		/194
101-040	35/65/93	385-050	146/185	530-224	21	612-025	97/204	770-301	116	900-000	152/156/190	902-913	165/167/168
101-045	35/204	386-050	144/185	530-225	21	612-118	97	770-320	117/186		/197		/172/173/190
101-051	34/95	401-051	35	605-001	88/91	612-121	97	770-336	117/186/205	900-001	151/156/190		/194/197
101-060	29/49/53	401-052	35	605-002	89/92/188/	612-125	97	770-502	108/109		/194/197/200	902-914	166/172/173
101-140	38/93	405-045	34		192/194	700-003	51/204	770-503	108/109/189	900-030	158		
101-145	56	431-045	34/197	605-007	88/91	700-004	51/189		/193/204	900-031	158	902-915	173
101-150	144	432-045	34/197	605-011	88/90	700-005	51/189/193	770-510	108	900-035	158	902-917	165/166/167
101-245	60	480-145	56	605-013	88/91		/204	770-522	108	900-100	154		/168/169/172
104-045	11/179	500-000	20/183/204	605-014	88/91	700-006	51	770-523	108	900-250	152/197		/173/194
105-045	11/179	500-007	15/20	605-018	89/92	700-099	53	770-532	108	900-303	152/188/189	902-918	173
106-045	34	500-008	15/20	605-019	88/90	710-003	52	770-533	108		/190/192/196		/173
106-145	37	500-009	15/20	605-020	88/90	710-004	52	770-542	108		/198/199/203	902-920	167/168/171
106-245	37	500-011	16/20	605-021	88/91	710-005	52	770-543	108	900-351	150/151	902-921	165/166/167
106-345	37	500-014	18/20	605-023	88/91	710-006	52	770-552	109	900-391	151		/168/169/170
110-045	10/179	500-015	18/20	605-024	89/91	720-000	54	770-553	109	900-392	153/190/197		/171
111-000	40	500-016	18	605-027	88/90	721-301	54	770-998	108	900-395	151/192/194	902-922	173
111-001	40/205	500-017	18/20	605-029	88/90	721-302	54	770-999	117/187		/196	902-923	168/169/173
112-045	10/179	500-018	18/20	605-030	88/90	721-303	54/204	771-011	118/187	900-396	151/188/189	902-924	168/169/171
120-045	11/179	500-019	17	605-031	89/92	721-304	55	771-036	118/187/205		/190/192/194	905-000	69
120-145	11/179	500-020	17	605-033	89/92	721-306	55	771-120	117/186		/200	905-001	68/69
131-045	34	500-021	17/20	605-034	89/92/188/	721-307	55	771-121	117/186	900-397	153	905-002	68/69
131-145	37	500-022	17/20		/190	721-308	55	771-136	117/186	900-398	153	905-003	68/69
132-045	34	500-023	18/20	605-036	88/91	721-309	55	771-137	117/186	900-399	151	905-004	68/69
193-008	145	500-024	18	605-039	88/90	721-310	55	772-011	118/187	900-400	150/188/189	905-005	68/69
193-016	145	500-112	16	605-040	88/90/183	722-530	54	772-036	118/187		/190/192/194	905-006	69/70
194-075	147/185	500-113	16		/185/188/189	723-000	57/61/109	773-000	186/187		/196/197/198	905-007	69/70
210-030	11/179	500-124	16		/190/192/194		/118	773-001	186/187		/199/200/202	905-008	71
214-045	11/179	500-125	15		/196/198/199	723-020	57/118	773-980	186	900-401	151	905-009	71
215-045	11/179/183	500-126	15/20		/205	723-050	109	773-981	186	900-402	151	905-010	71
	/204	500-127	15	605-041	88/90	723-051	109	773-982	109	900-450	153	905-011	71
215-145	11/204	500-129	17	605-057	88/90	723-052	109	773-983	109	900-451	153	905-012	69
218-045	11/179/183	500-130	17	605-058	89/91	736-005	54/204	775-000	113/189/193	900-806	161	905-013	71
218-145	11/204	500-131	17	605-059	89/92	741-100	63		/195	900-807	161	905-014	71
219-030	11/179	500-150	19	605-063	89/92	741-101	63	795-145	103	900-808	161	905-015	69
220-045	11/179/185	510-108	29/204	605-070	88/90	741-234	63	795-180	103	900-809	161	905-020	69
	/188/189/190	510-109	29	605-080	88/90	741-812	63	795-545	103	900-901	159	905-112	69
	/192/194/198	510-110	29	607-001	76/78	741-814	63	795-580	103	900-902	159	905-115	69
	/199/200/202	510-112	29	607-002	76/78/202	741-822	63	796-170	103	900-903	159	905-120	69
	/203	520-027	21		/203	741-823	63	796-570	103	900-904	159	905-212	69
220-145	11/179/204	520-028	21/204	607-007	76/78	741-827	63	797-180	102/205	900-906	160	905-215	69
220-245	11/179	520-029	22	607-014	76/78/202	741-828	63	797-230	102/188/193	900-907	160	905-220	69
220-345	154/185	520-030	22		/203	741-832	63	797-280	102	900-908	160	905-312	70
222-000	40	520-031	22	607-020	76/77/202	741-833	63	797-580	102/205	900-909	160	905-315	70
227-045	10/179	520-032	22		/203	741-842	63	797-630	102	900-911	157	905-412	70
232-003	146/185/205	520-035	22	607-021	76/78	741-843	63	797-680	102	900-912	157	905-415	70
242-003	146/205	520-110	48	607-027	76/77/202	742-106	63	798-145	102	900-913	157	905-421	71
270-145	56	520-113	48/205		/203	742-234	63	798-180	102/201	900-914	157	905-422	71
280-031	34	520-114	48	607-029	76/77	742-310	63	798-230	102/195	900-915	157	905-423	71
280-035	29/49/53/189	520-115	48/193	607-030	76/77	742-320	63	798-280	102	900-916	157	905-424	71
	/193	520-116	48	607-039	76/77/202	742-330	63	798-545	102	900-917	157	905-512	71
280-050	34/95/189	520-117	49		/203	742-340	63	798-580	102	900-921	160	905-612	69
285-050	34	520-118	49	607-040	76/77/205	742-350	63	798-630	102	900-922	159	905-615	69
287-040	35/65/93/185	520-122	21	607-080	76/77	742-816	63	798-680	102	900-923	160	905-620	69
287-045	35	520-123	21	607-100	79/80	742-826	63	800-000	27	900-924	159	932-031	129/191/195
287-050	35	520-124	21	607-101	79/80	742-829	63	800-001	25	901-011	155/188/189		/205
287-245	60	520-132	23	607-102	79/80	742-836	63	800-002	25		/190/192/194	932-032	129/191/201
294-050	144	520-133	23	607-103	79/80	742-846	63	800-003	25		/198/202	932-034	129/191/195
295-050	146	520-134	23	607-105	79/81	744-100	64	800-004	25	901-012	155/185		/201
322-045	10/179	520-135	23	607-106	79/81	744-101	64	800-005	25	901-021	155/188/189	932-035	128
327-045	10/179	520-136	23	607-107	79/81	744-220	64	800-006	27		/196/197	932-036	128/191
330-030	11/179/204	530-000	20/183/185	607-108	79/81	744-229	64	800-007	26	901-022	155	932-042	127/191/195
331-045	34		/188/189/192	607-110	79/81	744-312	64	800-011	26	901-031	155/189/190		/201/205
332-045	34		/194/199	607-111	79/81	744-313	64	800-021	26		/192/194/198	932-055	128
333-001	40/183	530-008	15/20	607-112	79/81	744-342	64	800-028	26		/199/203	932-058	128/191
335-030	11/179/204	530-009	15/20	607-113	79/81	744-343	64	800-030	26	901-032	155/188/190	932-059	128/191
340-000	40/205	530-012	16	607-115	79/81	744-812	64	801-030	12/179		/192/196/197	932-060	129/205
350-245	60	530-013	16	607-116	79/81	744-813	64	802-030	12/179		/198/199/200	932-061	129/191/205
351-040	35/65/93/183	530-014	18	607-120	79/82	744-815	64	802-032	13/178		/202	932-062	129/205
	/188/189/190	530-015	18/20	607-121	79/82	744-816	64	802-033	13/178	901-051	156	932-146	133/197/205
	/192/194/196	530-016	18	607-122	79/82	744-844	64	802-035	12	901-052	156	932-148	132
	/198/199/202	530-017	18/20	607-123	79/82	744-845	64	815-040	143	901-124	183	932-149	132/205
	/203/204	530-020	17/20	607-130	79/80	744-847	64	815-070	142	901-126	185	932-150	132
351-045	35	530-021	17/20	607-140	83/86	744-848	64	815-110	139	901-140	183	932-151	132
351-051	35	530-022	17/20	607-141	83/86	745-100	65	815-140	141	901-210	41	932-152	132
351-245	60	530-027	21	607-145	83/86	745-120	65	816-042	143	901-2			

SimCOAG	Simultane Aktivierung von 2 monopolaren Handgriffen Simultaneous activation of two monopolar handles L'activation simultanée de deux manches monopolaire Activación simultánea con dos mangos monopolares Attivazione simultanea di due manipoli monopolari	EASY (Elektrode application system)	Neutralelektroden-Überwachungssystem Return plate monitoring system Système de surveillance de l'électrode neutre Sistema de monitoreo del electrodo neutro Sistema di monitoraggio piastra paziente
Plug'n CUT COMFORT	Automatische Instrumentenidentifikation Automatic instrument identification Identification automatique d'instruments Identificación automática del instrumento Identificazione automatica di strumenti	Plug'n Cut	Gesteckerkennung für Standardinstrumente Plug-in detection for standard instruments Détection de connexion d'instruments standard Reconocimiento de la conexión de instrumentos estándar Sistema di rilevamento della connessione di strumenti standard
ISSys (Integrated safety system)	Integriertes Sicherheitssystem Integrated safety system Système de sécurité intégré Sistema integrado de seguridad Sistema di sicurezza integrato	AUTOSTART	Bipolare Pinzettenkoagulation ohne Fußschalter Bipolar forceps coagulation without footswitch Pince bipolaire de coagulation sans pédale Coagulación con pinzas bipolares, sin pedal Coagulazione con pinze bipolari senza interruttore a pedale
GastroCut	Spezialstromarten für die Gastroenterologie Special types of current for gastroenterology Courants spécifiques pour la gastro-entérologie Tipos de corriente especiales para la gastroenterología Speciali tipi di corrente per la gastroenterologia	MICRO	Begrenzte Regelung für feine Elektroden Limited power regulation for fine electrodes Puissance limitée pour des électrodes fines Regulación limitada para electrodos finos Regolazione di potenza accurata per elettrodi sottili
ARC CONTROL	Lichtbogenregelung für reproduzierbare Ergebnisse Arc control for reproducible results Régulation de l'arc électrique pour des résultats reproductibles Regulación del arco para obtener resultados reproducibles Regolazione dell'arco voltaico per risultati riproducibili	Bipolare Resektion	Spezialstromart für bipolare Resektoskope Special type of current for bipolar resectoscope Type de courant spécifique pour résectoscope bipolaire Corriente especial para resectoscopios bipolares Speciale tipo di corrente per resettoscopi bipolari
LIGATION	Bipolare Gewebe- und Gefäßversiegelung Bipolar tissue and vessel sealing Thermofusion bipolaire des vaisseaux et tissus Sellado bipolar de vasos y tejidos Sigillatura bipolare di vasi e tessuti	MetraLOOP®	Spezialstromart für MetraLOOP® Special type of current for MetraLOOP® Type de courant spécifique pour MetraLOOP® Corriente especial para MetraLOOP® Speciale tipo di corrente per MetraLOOP®

V_P	Maximal zulässige Spannung Maximum permitted voltage Tension maximale admissible Máxima tensión admisible Tensione massima ammessa
-------	--

Symbole
Symbols
Symboles
Símbolos
Simboli

 Allgemein Chirurgie General Surgery Chirurgie générale Cirugía general Chirurgia Generale	 Herzchirurgie Cardiac Surgery Chirurgie cardiaque Cirugía cardiovascular Cardiochirurgia	 Kinderchirurgie Pediatric Surgery Chirurgie pédiatrique Cirugía pediátrica Chirurgia Pediatrica	 Orthopädie und Unfallchirurgie Orthopedics and Traumatology Orthopédie et traumatologie Ortopedia y cirugía traumatólogica Ortopedia e Chirurgia Traumatologica	 Plastische und Ästhetische Chirurgie Plastic and Aesthetic Surgery Chirurgie plastique et esthétique Cirugía estética y plástica Chirurgia Plastica ed Estetica
 Thoraxchirurgie Thoracic Surgery Chirurgie thoracique Cirugía torácica Chirurgia Toracica	 Viszeralchirurgie Visceral Surgery Chirurgie viscérale Cirugía visceral Chirurgia Digestiva	 Gynäkologie Gynaecology Gynécologie Ginecología Ginecologia	 HNO ENT ORL Otorrinolaringología ORL	 Neurochirurgie Neuro Surgery Neurochirurgie Neurocirugía Neurochirurgia
 Dermatologie Dermatology Dermatologie Dermatología Dermatologia	 Mund-Kiefer-Gesichts- Chirurgie Oral and maxillofacial Surgery Chirurgie maxillo-faciale Cirugía oral y maxilofacial Chirurgia Maxillo-Facciale	 Urologie Urology Urologie Urología Urologia	 Gastroenterologie Gastroenterology Gastroentérologie Gastroenterología Gastroenterologia	 Pulmologie Pneumology Pneumologie Neumología Pneumologia

BOWA
EINFACH SICHER

BOWA-electronic GmbH & Co. KG
Heinrich-Hertz-Strasse 4 – 10
72810 Gomaringen | Germany

Phone +49 (0) 7072-6002-0
Fax +49 (0) 7072-6002-33
info@bowa.de | bowa-medical.com

