

Product Catalogue

Surgical suture material

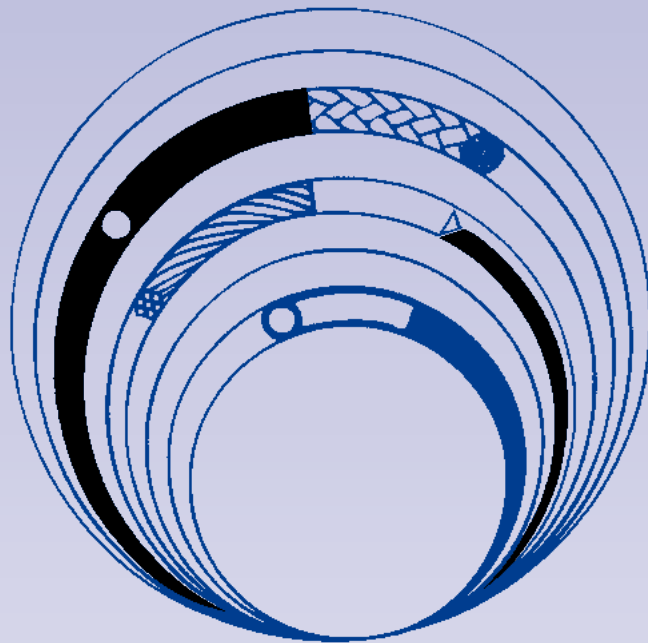

Catgut GmbH

Gewerbepark 18
P.O.Box 10002
08254 Markneukirchen
Germany

Phone: 0049 037422 583-0
Fax: 0049 037422 583-39

e-mail: catgut@catgut.de
Internet: www.catgut.de

2010



Gewerbepark 18
Postfach 10002
08254 Markneukirchen
Germany

Phone: 0049 037422 58334 . E-Mail: catgut@catgut.de
Fax: 0049 037422 58339 . Internet: www.catgut.de

From the
gut string



to most modern
surgical sutures



Time of delivery		1
Surgical suture materials		2
Needlecode		4
Atraumatic Needles		6
Marlin	Needles sutures	10
absorbable, braided, coated	BLACKLINE-Needles	14
	Multistrand – detachable needles	15
	Multistrand – undetachable needles	16
	Loops	17
	Ligatures	18
Marlin rapid	Needled sutures	20
absorbable, braided, coated	Ligatures	22
PCL	Needled sutures	24
absorbable, monofilament, coated	Special products – Needled sutures	27
MARISORB	Needled sutures	30
absorbable, monofilament	Loops	34
MARICRYL	Needled sutures undyed	36
absorbable, monofilament	Ligatures	37
	Needled sutures violet	38
Polyester-S green	Needled sutures	40
absorbable, monofilament	Ligatures	46
Polyester white	Needled sutures	48
non-absorbable, braided, uncoated	Ligatures	50
GREENFIL	Needled sutures	52
non-absorbable, braided, uncoated green	Ligatures	53
MAPROLEN	Needled sutures	54
monofilament, non-absorbable blue		

MARILON	Needled sutures	60
non-absorbable, monofilament, blue	Pretied ligating loop	63
MARIDERM	Needled sutures	64
non-absorbable, monofilament, blue		
Silk-S black	Needled sutures	66
non absorbable, braided, coated	Ligatures	68
Steel Wire	Needled sutures	69
non absorbable, monofilament	Sternum wire	70
non absorbable, polyfilament	Needled sutures	71
Needled sutures for microsurgery & ophthalmology		
Marlin (PGA)	Needled sutures	72
Maprolen (PP)	Needled sutures	76
Marilon (PVDF)	Needled sutures	77
Mariderm (Polyamid 6.6)	Needled sutures	79
Polyester-S green	Needled sutures	82
Polyester white	Needled sutures	82
Silk-S black	Needled sutures	83
Special Sets		
– Dynamic supporting suture		84
– Cervix-Set		87
– Needle Sets and Accessories		89
Polyester tape		90
non-absorbable, green or white		
Others		
– Loops		91
– New type Ileus decompression tube		92
– Minimal invasive surgery		96

Time of delivery

Our catalogue contains most products of Catgut GmbH. For export business we work on order basis only, which means that delivery time amounts to about six weeks depending on the ordered quantity.

Absorbable braided:

MARLIN®

Marlin® is a synthetic absorbable suture material made from polyglycolic acid (PGA). This suture is extremely smooth due to its precision braiding and coating. It is characterised by perfect knot stability, high tensile strength and soft tissue penetration.

Marlin® degrades in the human body by hydrolysis with very low tissue reaction. Tensile strength is reduced by 50 per cent after 14 to 16 days, after about 90 days degradation is completed.

Marlin® violet/undyed is provided as needled suture, as ligature pack and as loop.

MARLIN® rapid

Marlin® rapid is a synthetic absorbable suture material made from polyglycolic acid (PGA). Compared to Marlin this PGA has a lower molecular weight and thus a shorter absorption time. The braided suture is coated and ensures light knot sliding and excellent tissue penetration.

Marlin® rapid degrades in the human body by hydrolysis with very low tissue reaction. Tensile strength is reduced by 50 per cent after 7 days, after about 42 days degradation is completed.

Marlin® rapid undyed is provided as needled suture and as ligature pack.

Absorbable monofilament:

PCL

PCL is a monofilament made from Copoly(Caprolacton-L-Lactide). The synthetic suture is very smooth and coated for better sliding.

PCL knots are extremely stable, they retain their size and stay in place.

The tensile strength of PCL is reduced by 50 per cent after 45 to 50 days, after about 180 days degradation by hydrolysis is completed.

PCL violet/undyed is provided as needled suture and as loop.

MARISORB®

Marisorb® is an absorbable monofilament suture material made from Polydioxanone. The suture offers pleasant handling, best knot security and maximum tissue acceptance.

You should use Marisorb®, whenever you need wound adaptation for a longer period of time with an absorbable suture. Tensile strength reduces by half after 6 to 7 weeks.

After 180 to 210 days the complete degradation by hydrolysis is finished.

You can use Marisorb® as needled suture or as loop suture.

MARICRYL®

Maricryl® is a monofilament absorbable suture material made from a Poly(glycolide-e-caprolactone) – combined polymer.

Maricryl® suits in particular for wound adaptation in a shorter period of time (up to 2 weeks) and whenever the advantages of a monofilament are requested. Maricryl® is soft and smooth in tissues. It has a high knot tensile strength and ensures safe knots. It can be used for adapting soft tissues, for ligation, wound closure, intestine, peritoneum, uterus. It is provided as needled sutures.

Maricryl® is provided as needled suture.

Non-absorbable braided:

POLYESTER-S green

Polyester-S green is a synthetic non-absorbable suture material made from precision braided Polyethylene terephthalate. The coating of the suture is physiologically inert.

This way of surface processing ensures high smoothness, outstanding knotability and reduces capillarity.

Polyester-S green is provided as needled suture, as ligature and as dispenser pack.

POLYESTER white / GREENFIL

Polyester is a synthetic non-absorbable suture material made from precision braided Polyethylene terephthalate.

You can use Polyester in white colour or as Greenfil in green. It is characterised by perfect knot stability, high tensile strength and soft tissue penetration. Polyester white and Greenfil are provided as needled sutures and as ligature pack. You can obtain polyester white also as dispenser pack.

Silk-S

Silk-S is a natural non-absorbable suture material made from silk fibroin, a natural protein forming the fibre substance of the cocoon threads of silk moth (*Bombyx mori*). The sutures are coated to reduce capillarity.

Silk-S is very flexible and has a stable and good tensile strength. The suture is coloured in black. Silk-S is provided as needled suture, as ligature and as dispenser pack. You can also obtain the dispenser pack in natural silk colour.

Non-absorbable monofilament:

MAPROLEN®

Maprolen is a non-absorbable monofilament suture material made from Polypropylene. It is dyed blue for better visibility in the wound area. Maprolen® is extremely soft, the smoothness allows optimum handling for user.

Because of the constant suture diameter and the smooth surface Maprolen® can also be used in septic surgery, as the minimum tissue reaction makes it the ideal suture for critical wounds also. You can achieve an optimum of cosmetic results. Maprolen® is provided as needled suture or as pretied ligating loop.

MARILON®

Marilon® is a non-absorbable monofilament suture material made from polyvinylidene fluoride (PVDF), which is characterised by its complete inertness. The suture is coloured in blue. Marilon® suits very well for cosmetic skin and vascular sutures.

Marilon® has a very high tensile strength and a relatively small elongation. By a short stretching of the suture you remove the curling of monofilaments. Marilon® is provided as needled suture or as pretied ligating loop.

MARIDERM®

Mariderm® is a non-absorbable monofilament suture material made from copolyamide 6-6,6. The suture is coloured in blue and has a smooth surface.

Mariderm® is used for skin closures. It has a high tensile strength, is easy to knot and forms stable knots.

Mariderm® is provided as needled suture.

Steel wire

Surgical steel wire is made from stainless steel and it is offered as monofilament or as drilled polyfilament.

The tensile strength of steel wire is very high. Due to the lack of capillarity steel wire is extremely compatible in tissues. Steel wire is provided as needled suture.

Needlecode:

1. The first letter indicates the needle shape.

H = 1/2-circle	K = ski-shaped
D = 3/8-circle	J = 90°-50°-asymptotic circle
F = 5/8-circle	G = straight
V = 1/4-circle	T = special form for trocar incision

2. The second letter indicates the needle type.

R = round body	L = lancet
S = cutting	I = incision needle

3. The third letter indicates special needles.

B = black needle (Blackline)	s = thick needle
T = trocar point	es = extra thick needle
M = micro point	d = thin needle
S = special point	f = flat needle

























4. The number indicates straight needle length in mm.

HR	●	= 1/2-circle, round body, taper point
HRB..f	⊖	= 1/2-circle, flat round body, black (Blackline)
HS	▼	= 1/2-circle, cutting
DR	●	= 3/8-circle, round body, taper point
DRB..f	⊖	= 3/8-circle, flat round body, black (Blackline)
DRC	⊕	= 3/8-circle, round body, cardio point
DS	▼	= 3/8-circle, cutting
FR	●	= 5/8-circle, round body, taper point
GR	●	= straight, round body, taper point
GS	▼	= straight, cutting
KR	●	= ski-shaped, round body, taper point
KS	▼	= ski-shaped, cutting
TI	⊙	= special form for trocar incision, trocar point, round body
HRT	⊕	= 1/2-circle, round body, trocar point
DRT	⊕	= 3/8 circle, round body, trocar point
HRM	⊙	= 1/2-circle, round body, micro point
DRM	⊙	= 3/8-circle, round body, micro point
HSM	▽	= 1/2-circle, cutting, micro point
DSM	▽	= 3/8-circle, cutting, micro point
HLM	▽	= 1/2-circle, round body, lancet micro point
DLM	▽	= 3/8-circle, round body, lancet micro point
GLM	▽	= straight, round body, lancet micro point
JLM	▽	= 90°-50° asymptotic circle, round body, lancet micro point
VLM	▽	= 1/4-circle, round body, lancet micro point
HRN	○	= 1/2-circle, round body, blunt point
DSS	▽	= 3/8-circle, cutting, slim point

Atraumatic needles











HR = 1/2 -circle, round body, taper point

-  HR 10
-  HR 13
-  HR 17
-  HR 17S
-  HR 20
-  HR 22
-  HR 22s
-  HR 26
-  HR 26s
-  HR 27s
-  HR 30
-  HR 37
-  HR 37s
-  HR 37es
-  HR 40
-  HR 40s
-  HR 43
-  HR 43s
-  HR 48
-  HR 48s
-  HR 60
-  HR 60s
-  HR 65
-  HR 76





HRT = 1/2 -circle, round body, trocar point

-  HRT 17
-  HRT 26
-  HRT 27
-  HRT 40
-  HRT 43
-  HRT 43s
-  HRT 48s
-  HRT 58







FR = 5/8- circle, round body, taper point

-  FR 27
-  FR 36
-  FR 40



GR = straight, round body, taper point

-  GR 19
-  GR 38
-  GR 45
-  GR 51
-  GR 65



DR = 3/8-circle, round body, taper point

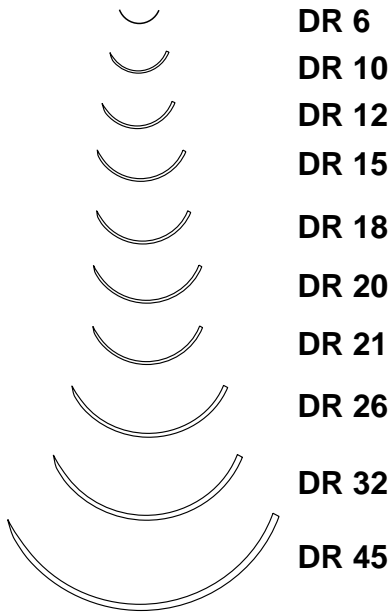

DS = 3/8-circle, cutting

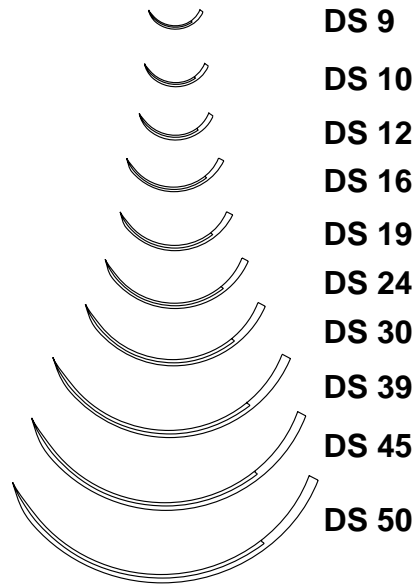

DRT = 3/8 -circle, round body, trocar point

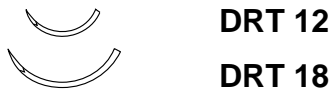

DSM = 3/8 - circle, cutting, micro point

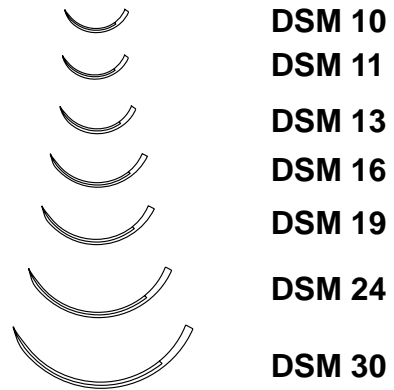

HRN = 1/2 -circle, round body, blunt point

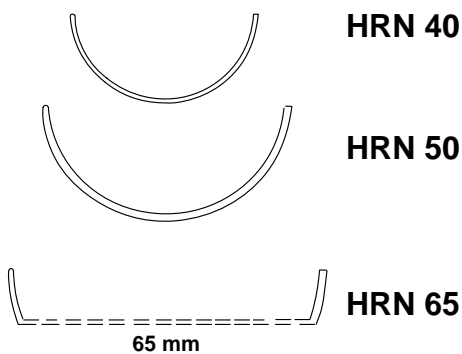

DSS = 3/8 - circle, cutting, slim point

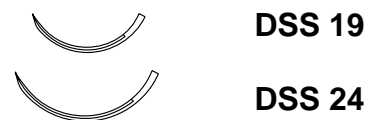

▼
HS = 1/2 -circle, cutting

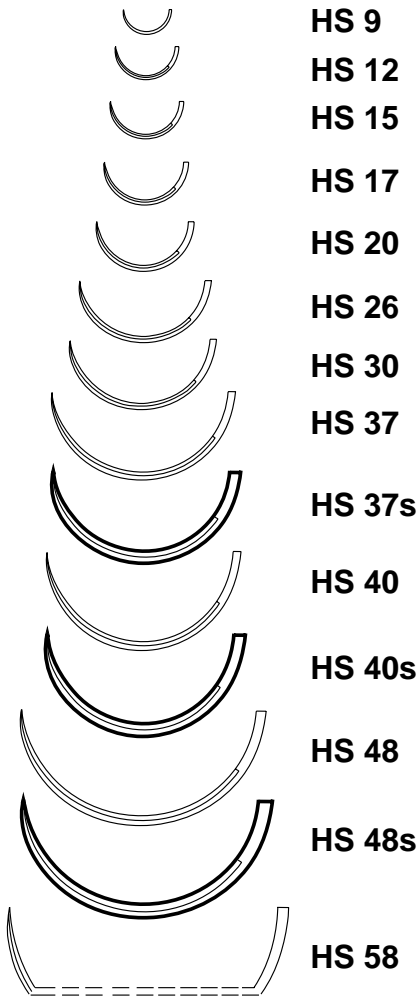

⊖
HRB .. f = 1/2 -circle, flat round body, black

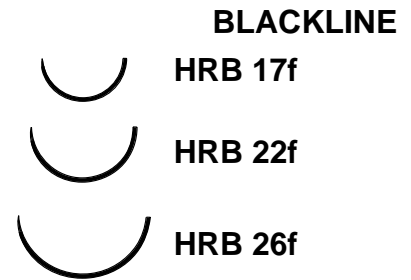

⊖
DRB .. f = 3/8-circle, flat round body, black

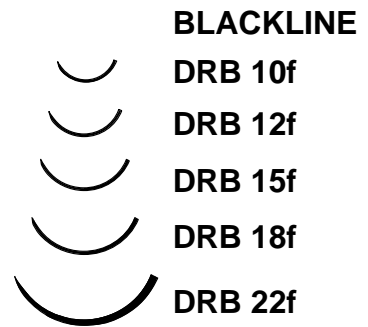

DRC = 3/8-circle, round body, cardio point



▼
GS = straight, cutting

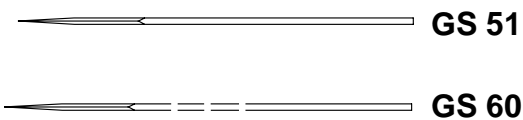

▼
KS = ski-shaped, cutting





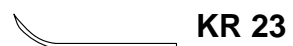



●
KR = ski-shaped, round body, taper point





3/8-circle, spatulated needle, lancet micro point

-  DLM 15-4
-  DLM 15-5
-  DLM 15-6
-  DLM 20-6
-  DLM 24-8
-  DLM 28-10







1/2-circle, spatulated needle, lancet micro point

-  HLM 20-6



1/4-circle, spatulated needle, lancet micro point

-  VLM 20-6
-  VLM 28-8
-  VLM 33-8
-  VLM 34-8
-  VLM 43-8



90°-50° asymptotic circle, round body, lancet micro point

-  JLM 15-5





Straight, spatulated needle, lancet micro point

-  GLM 15-16









3/8-circle, cutting, micro point

-  DSM 20-6
-  DSM 20-8
-  DSM 33-10





3/8-circle, round body, micro point

-  DRM 7-4
-  DRM 10-4
-  DRM 15-4
-  DRM 7-5
-  DRM 10-5
-  DRM 15-6
-  DRM20-6









1/2-circle, round body, micro point

-  HRM 10-5
-  HRM 15-6
-  HRM 20-6



3/8-circle, round body, trocar point

-  DRT 7-4
-  DRT 10-4
-  DRT 10-5
-  DRT 15-5
-  DRT 20-7
-  DRT 20-9
-  DRT 24-13









Coding:	1st letter: Indicates the needle shape
	2nd letter: Type of needle
	3rd letter: Type of point
	1st digit: Diameter in 1/100 mm
	2nd digit: Length (Arc length) in mm

MARLIN®

absorbable

braided, coated







Needled sutures

Needle description	Article-No.	Colour	USP	EP	Length	UoS
 HR 13	17241009 17241017	violet violet	5/0 4/0	1 1,5	70 cm 70 cm	24 24
 HR 17	17241071 17241079 17241087 17241095	violet violet violet violet	5/0 4/0 3/0 2/0	1 1,5 2 3	70 cm 70 cm 70 cm 70 cm	24 24 24 24
 HR 22	17241135 17241143 17241151 17241159	violet violet violet violet	4/0 3/0 2/0 0	1,5 2 3 3,5	70 cm 70 cm 70 cm 70 cm	24 24 24 24
 HR 26	17241201 17241209 17241217 17241180 17241184	violet violet violet violet violet	3/0 2/0 0 3/0 2/0	2 3 3,5 2 3	70 cm 70 cm 70 cm 90 cm 90 cm	24 24 24 24 24
 HR 26d	17247174 17247185	violet violet	3/0 2/0	2 3	70 cm 70 cm	24 24
 HR 27s	17241255 17241260 17241264 17241270 17241274	violet violet violet violet violet	0 1 0 1 2	3,5 4 3,5 4 5	70 cm 70 cm 90 cm 90 cm 90 cm	24 24 24 24 24
 HR 30	17241281 17241289 17241297 17241313	violet violet violet violet	3/0 2/0 0 2	2 3 3,5 5	70 cm 70 cm 70 cm 70 cm	24 24 24 24
 HR 37	17241367 17241369 17241377 17241385 17241361 17241373 17241380	violet violet violet violet violet violet violet	3/0 2/0 0 1 2/0 0 1	2 3 3,5 4 3 3,5 4	70 cm 70 cm 70 cm 70 cm 90 cm 90 cm 90 cm	24 24 24 24 24 24 24

MARLIN®

absorbable
braided, coated

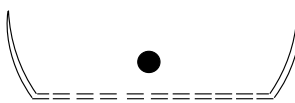
Needled sutures







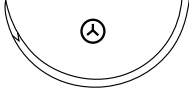

Needle description	Article-No.	Colour	USP	EP	Length	UoS
 HR 37s	17241401	violet	2/0	3	70 cm	24
	17241403	violet	0	3,5	70 cm	24
	17241407	violet	1	4	70 cm	24
	17241408	violet	2	5	70 cm	24
	17241409	violet	0	3,5	90 cm	24
	17241411	violet	1	4	90 cm	24
	17241413	violet	2	5	90 cm	24
 HR 40	17241431	violet	1	4	70 cm	24
	17241350	violet	2	5	90 cm	24
	17241349	violet	1	4	90 cm	24
 HR 43	17241433	violet	2/0	3	70 cm	24
	17241441	violet	0	3,5	70 cm	24
	17241449	violet	1	4	70 cm	24
	17241457	violet	2	5	70 cm	24
	17241473	violet	1	4	90 cm	24
 HR 43s	17241488	violet	0	3,5	90 cm	24
	17241490	violet	1	4	90 cm	24
	17241495	violet	2	5	90 cm	24
 HR 48s	17241501	violet	0	3,5	70 cm	24
	17241506	violet	1	4	70 cm	24
	17241512	violet	2	5	70 cm	24
	17241517	violet	0	3,5	90 cm	24
	17241523	violet	1	4	90 cm	24
	17241530	violet	2	5	90 cm	24
 HR 60	17241548	violet	0	3,5	70 cm	24
	17241549	violet	1	4	70 cm	24
	17241539	violet	0	3,5	90 cm	24
	17241540	violet	1	4	90 cm	24
	17241544	violet	2	5	90 cm	24
	17246498	undyed	2	5	90 cm	24
 HR 76	17241564	violet	2/0	3	70 cm	24
	17241570	violet	0	3,5	70 cm	24
	17241577	violet	1	4	70 cm	24
	17246531	undyed	2	5	90 cm	24

MARLIN®

absorbable

braided, coated



Needled sutures

Needle description	Article-No.	Colour	USP	EP	Length	UoS
 HRT 26	17241667	violet	3/0	2	70 cm	24
	17241668	violet	2/0	3	70 cm	24
	17241669	violet	0	3,5	70 cm	24
	17241674	violet	3/0	2	90 cm	24
 HRT 37	17241681	violet	2/0	3	70 cm	24
	17241685	violet	0	3,5	75 cm	24
	17241692	violet	1	4	90 cm	24
 DS 12	17241808	violet	5/0	1	70 cm	24
	17246540	undyed	4/0	1,5	70 cm	24
 DS 16	17241857	violet	5/0	1	70 cm	24
	17241885	violet	4/0	1,5	45 cm	24
	17246578	undyed	4/0	1,5	70 cm	24
	17241865	violet	4/0	1,5	70 cm	24
	17241890	violet	3/0	2	45 cm	24
	17241873	violet	3/0	2	70 cm	24
 DS 19	17241960	violet	4/0	1,5	45 cm	24
	17241924	violet	4/0	1,5	70 cm	24
	17241964	violet	3/0	2	45 cm	24
	17241928	violet	3/0	2	70 cm	24
	17241974	undyed	3/0	2	70 cm	24
 DS 24	17242001	violet	3/0	2	70 cm	24
	17241981	undyed	3/0	2	70 cm	24
	17242009	violet	2/0	3	70 cm	24
	17246761	undyed	2/0	3	70 cm	24
 HS 30	17242163	violet	3/0	3	70 cm	24
	17242165	violet	0	3,5	70 cm	24
	17242167	violet	1	4	90 cm	24
 HS 37	17242187	violet	1	4	70 cm	24
	17242192	violet	2	5	70 cm	24
	17242173	violet	0	3,5	90 cm	24
	17242194	violet	1	4	90 cm	24
 GR 19	17242209	violet	4/0	1,5	70 cm	24

MARLIN®







absorbable
braided, coated

Needled sutures

Needle description	Article-No.	Colour	USP	EP	Length	UoS
 DSM 12	17246787	undyed	5/0	1	45 cm	24
 DSM 19	17246799 17246801	undyed undyed	4/0 3/0	1,5 2	45 cm 45 cm	24 24
 DSM 24	17242050	violet	3/0	2	70 cm	24

MARLIN®absorbable
braided, coated**BLACKLINE - Needles**









Needled sutures

Needle description	Article-No.	Colour	USP	EP	Length	UoS
 Blackline HRB 17f	17341124	violet	4/0	1,5	45 cm	24
	17341125	violet	3/0	2	45 cm	24
	17341080	violet	4/0	1,5	70 cm	24
	17341088	violet	3/0	2	70 cm	24
 Blackline HRB 22f	17341133	violet	2/0	3	45 cm	24
	17341144	violet	3/0	2	70 cm	24
	17341152	violet	2/0	3	70 cm	24
	17341165	violet	3/0	2	90 cm	24
	17341169	violet	2/0	3	90 cm	24
 Blackline HRB 26f	17341234	violet	3/0	2	45 cm	24
	17341199	violet	4/0	1,5	70 cm	24
	17341202	violet	3/0	2	70 cm	24
	17341210	violet	2/0	3	70 cm	24
	17341218	violet	0	3,5	70 cm	24
	17341181	violet	3/0	2	90 cm	24
	17341185	violet	2/0	3	90 cm	24
 Blackline HRB 17f Multistrand - detachable needles	17343083	violet	3/0	2	4x45 cm	24
 Blackline HRB 22f Multistrand - detachable needles	17343111	violet	3/0	2	4x45 cm	24
 Blackline HRB 26f Multistrand - detachable needles	17343253	violet	3/0	2	1x70 cm	24
	17343303	violet	3/0	2	4x45 cm	24
	17343402	violet	3/0	2	4x70 cm	24
	17343410	violet	2/0	3	4x70 cm	24

MARLIN®

absorbable
braided, coated





Multistrand - detachable needles

Needle description	Article-No.	Colour	USP	EP	Length	UoS
 4xHR 17d DN	17247351	violet	4/0	1,5	45 cm	24
 4xHR 22 DN	17243100 17243200 17243110 17243209 17243119 17243218	violet violet violet violet violet violet	4/0 4/0 3/0 3/0 2/0 2/0	1,5 1,5 2 2 3 3	45 cm 70 cm 45 cm 70 cm 45 cm 70 cm	24 24 24 24 24 24
 4xHR 22d DN	17247405	violet	3/0	2	70 cm	24
 4xHR 26 DN	17243302 17243401 17243311 17243409	violet violet violet violet	3/0 3/0 2/0 2/0	2 2 3 3	45 cm 70 cm 45 cm 70 cm	24 24 24 24
 4xHR 27s DN	17243466 17243475 17243471	violet violet violet	0 1 1	3,5 4 4	70 cm 45 cm 70 cm	24 24 24
 4xHR 37 DN	17243695	violet	2/0	3	45 cm	24
 4xHR 37s DN	17243508 17243516 17243524 17243547 17243551	violet violet violet violet violet	0 1 2 0 1	3,5 4 5 3,5 4	45 cm 45 cm 45 cm 70 cm 70 cm	24 24 24 24 24
 4xHR 40s DN	17243559 17243566	violet violet	1 2	4 5	45 cm 70 cm	24 24

MARLIN®

absorbable
braided, coated

Multistrand - undetachable needles

Needle description	Article-No.	Colour	USP	EP	Length	UoS
 4xHR 22	17243637 17243640	violet violet	3/0 2/0	2 3	70 cm 70 cm	24 24
 4xHR 26	17243632 17243644 17243650	violet violet violet	2/0 3/0 2/0	3 2 3	45 cm 70 cm 70 cm	24 24 24
 4xHR 27s	17243662 17243664	violet violet	0 1	3,5 4	70 cm 70 cm	24 24
 4xHR 37	17243712	violet	2/0	3	70 cm	24
 4xHR 37s	17243819 17243831	violet violet	0 1	3,5 4	45 cm 70 cm	24 24

MARLIN®

absorbable
braided, coated

Loop sutures

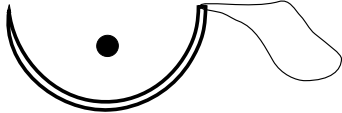
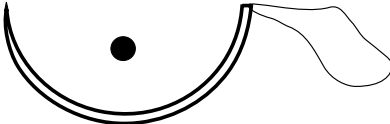
Needle description	Article-No.	Colour	USP	EP	Length	UoS
 HR 40s	17244100	violet	1	4	150 cm	12
 HR 48s	17244220	violet	1	4	150 cm	12

Pretied ligating loops

	Article-No.	Colour	USP	EP	Length	UoS
	17244310	violet	2/0	3		12
	17244314	violet	0	3,5		12
	17244320	violet	1	4		12
	17244322	violet	2	5		12

Roeder - loops

	Article-No.	Colour	USP	EP	Length	UoS
	17248351	undyed	2/0	3	60 cm	12
	17248355	undyed	0	3,5	60 cm	12
	17248360	undyed	1	4	60 cm	12
	17248364	undyed	2	5	60 cm	12

MARLIN®absorbable
braided, coated

Ligatures

	Article-No.	Colour	USP	EP	Length	UoS
Ligatures - violet	17240003	violet	5/0	1	6x45 cm	24
	17240011	violet	4/0	1,5	6x45 cm	24
	17240019	violet	3/0	2	6x45 cm	24
	17240027	violet	2/0	3	6x45 cm	24
	17240035	violet	0	3,5	6x45 cm	24
	17240043	violet	1	4	6x45 cm	24
	17240051	violet	2	5	6x45 cm	24
	17240059	violet	5/0	1	3x45 cm	24
	17240067	violet	4/0	1,5	3x45 cm	24
	17240075	violet	3/0	2	3x45 cm	24
	17240083	violet	2/0	3	3x45 cm	24
	17240091	violet	0	3,5	3x45 cm	24
	17240099	violet	1	4	3x45 cm	24
	17240102	violet	2	5	3x45 cm	24
	17240107	violet	5/0	1	10x45 cm	24
	17240115	violet	4/0	1,5	10x45 cm	24
	17240120	violet	3/0	2	10x45 cm	24
	17240129	violet	2/0	3	10x45 cm	24
	17240137	violet	0	3,5	10x45 cm	24
	17240145	violet	1	4	10x45 cm	24
	17240153	violet	2	5	10x45 cm	24
	17240201	violet	5/0	1	2x70 cm	24
	17240209	violet	4/0	1,5	2x70 cm	24
	17240218	violet	3/0	2	2x70 cm	24
	17240225	violet	2/0	3	2x70 cm	24
	17240233	violet	0	3,5	2x70 cm	24
	17240241	violet	1	4	2x70 cm	24
	17240250	violet	2	5	2x70 cm	24
	17240302	violet	5/0	1	5x70 cm	24
	17240310	violet	4/0	1,5	5x70 cm	24
	17240319	violet	3/0	2	5x70 cm	24
	17240327	violet	2/0	3	5x70 cm	24
	17240335	violet	0	3,5	5x70 cm	24
	17240343	violet	1	4	5x70 cm	24
	17240351	violet	2	5	5x70 cm	24

MARLIN®absorbable
braided, coated









Ligatures

	Article-No.	Colour	USP	EP	Length	UoS	
Ligatures - violet	17240276	violet	4/0	1,5	2x90 cm	24	
	17240280	violet	3/0	2	2x90 cm	24	
	17240284	violet	2/0	3	2x90 cm	24	
	17240288	violet	0	3,5	2x90 cm	24	
	17240290	violet	1	4	2x90 cm	24	
	17240294	violet	2	5	2x90 cm	24	
	17240380	violet	3/0	2	5x90 cm	24	
	17240384	violet	2/0	3	5x90 cm	24	
	Ligatures - undyed	17245011	undyed	4/0	1,5	6x45 cm	24
		17245019	undyed	3/0	2	6x45 cm	24
17245027		undyed	2/0	3	6x45 cm	24	
17245035		undyed	0	3,5	6x45 cm	24	
17245060		undyed	5/0	1	3x45 cm	24	
17245067		undyed	4/0	1,5	3x45 cm	24	
17245075		undyed	3/0	2	3x45 cm	24	
17245083		undyed	2/0	3	3x45 cm	24	
17245091		undyed	0	3,5	3x45 cm	24	
17245099		undyed	1	4	3x45 cm	24	
17245155		undyed	4/0	1,5	12x45 cm	24	
17245157		undyed	3/0	2	12x45 cm	24	
17245160		undyed	2/0	3	12x45 cm	24	
17245164		undyed	0	3,5	12x45 cm	24	
17245168		undyed	1	4	12x45 cm	24	
17245172		undyed	2	5	12x45 cm	24	
17245233		undyed	0	3,5	2x70 cm	24	
17245241		undyed	1	4	2x70 cm	24	
17245319		undyed	3/0	2	5x70 cm	24	
17245327		undyed	2/0	3	5x70 cm	24	
17245335		undyed	0	3,5	5x70 cm	24	
17245343		undyed	1	4	5x70 cm	24	
17245351		undyed	2	5	5x70 cm	24	

MARLIN® rapid

absorbable
braided, coated



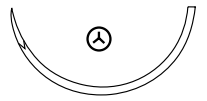





Needled sutures

Needle description	Article-No.	Colour	USP	EP	Length	UoS
 HR 17	17261074	undyed	5/0	1	70 cm	24
	17261082	undyed	4/0	1,5	70 cm	24
	17261090	undyed	3/0	2	70 cm	24
 HR 22	17261140	undyed	4/0	1,5	70 cm	24
	17261144	undyed	3/0	2	70 cm	24
	17261150	undyed	2/0	3	70 cm	24
 HR 26	17261183	undyed	3/0	2	70 cm	24
	17261186	undyed	2/0	3	70 cm	24
	17261192	undyed	0	3,5	70 cm	24
 HR 27s	17261257	undyed	2/0	3	70 cm	24
	17261266	undyed	0	3,5	70 cm	24
	17261272	undyed	1	4	70 cm	24
	17261275	undyed	2	5	70 cm	24
 HR 37s	17261412	undyed	2/0	3	90 cm	24
	17261420	undyed	0	3,5	90 cm	24
	17261422	undyed	1	4	90 cm	24
	17261425	undyed	2	5	90 cm	24
 HR 43s	17261511	undyed	0	3,5	90 cm	24
	17261515	undyed	1	4	90 cm	24
	17261521	undyed	2	5	90 cm	24
 HR 48s	17261566	undyed	1	4	90 cm	24
	17261572	undyed	2	5	90 cm	24
 HRT 26	17261676	undyed	3/0	2	45 cm	24
 HRT 37	17261700	undyed	2/0	3	90 cm	24
	17261705	undyed	0	3,5	90 cm	24
	17261710	undyed	1	4	90 cm	24

MARLIN® rapid

absorbable
braided, coated

Needled sutures

Needle description	Article-No.	Colour	USP	EP	Length	UoS
 HS 15	17261844 17261848	undyed undyed	4/0 3/0	1,5 2	45 cm 45 cm	24 24
 HS 20	17261879 17261883	undyed undyed	3/0 2/0	2 3	45 cm 45 cm	24 24
 DS 19	17262030 17262034 17262049	undyed undyed undyed	4/0 3/0 3/0	1,5 2 2	45 cm 45 cm 70 cm	24 24 24
 DS 24	17262066 17262091 17262070	undyed undyed undyed	3/0 3/0 2/0	2 2 3	45 cm 70 cm 45 cm	24 24 24
 DSM 11	17262107	undyed	6/0	0,7	45 cm	24
 DSM 13	17262130 17262134	undyed undyed	5/0 4/0	1 1,5	45 cm 45 cm	24 24
 DSM 19	17262160 17262164	undyed undyed	4/0 3/0	1,5 2	45 cm 45 cm	24 24
 DSM 24	17262181 17262190 17262185 17262194	undyed undyed undyed undyed	3/0 3/0 2/0 2/0	2 2 3 3	45 cm 70 cm 45 cm 70 cm	24 24 24 24

MARLIN® rapid

absorbable
braided, coated









Ligatures

	Article-No.	Colour	USP	EP	Length	UoS
Ligatures	17260017	undyed	3/0	2	3x45 cm	24
	17260020	undyed	2/0	3	3x45 cm	24
	17260022	undyed	0	3,5	3x45 cm	24
	17260070	undyed	3/0	2	6x45 cm	24
	17260074	undyed	2/0	3	6x45 cm	24
	17260081	undyed	0	3,5	6x45 cm	24
	17260085	undyed	1	4	6x45 cm	24
	17260227	undyed	2/0	3	2x70 cm	24
	17260230	undyed	0	3,5	2x70 cm	24
	17260236	undyed	1	4	2x70 cm	24
	17260240	undyed	2	5	2x70 cm	24

PCL

absorbable
monofilament, coated









Needled sutures

Needle description	Article-No.	Colour	USP	EP	Length	UoS
 HR 13	17281042	violet	6/0	0,7	70 cm	24
	17281050	violet	5/0	1	70 cm	24
	17281057	violet	4/0	1,5	70 cm	24
	17281061	violet	3/0	2	70 cm	24
	17281065	violet	2/0	3	70 cm	24
 2xHR 13	17281099	violet	5/0	1	70 cm	24
 HR 17	17281179	violet	6/0	0,7	70 cm	24
	17281181	violet	5/0	1	70 cm	24
	17281189	violet	4/0	1,5	70 cm	24
	17281192	violet	3/0	2	70 cm	24
 HR 17s	17281139	violet	3/0	2	70 cm	24
	17281140	violet	2/0	3	70 cm	24
 2xHR 17	17281212	violet	2/0	3	90 cm	24
	17281200	violet	4/0	1,5	70 cm	24
 HR 22	17281220	violet	4/0	1,5	70 cm	24
	17281215	violet	4/0	1,5	90 cm	24
	17281227	violet	3/0	2	70 cm	24
	17281231	violet	2/0	3	70 cm	24
	17281235	violet	0	3,5	70 cm	24
 HR 22s	17281266	violet	2/0	3	70 cm	24
	17281274	violet	0	3,5	70 cm	24
 HR 26	17281331	violet	4/0	1,5	70 cm	24
	17281338	violet	3/0	2	70 cm	24
	17281346	violet	2/0	3	70 cm	24
	17281354	violet	0	3,5	70 cm	24
 2xHR 26	17281374	violet	4/0	1,5	70 cm	24
	17281378	violet	3/0	2	70 cm	24
	17281382	violet	2/0	3	70 cm	24
	17281384	violet	0	3,5	70 cm	24

PCL

absorbable
monofilament, coated











Needled sutures

Needle description	Article-No.	Colour	USP	EP	Length	UoS
 HR 27s	17281531 17281537 17281543	violet violet violet	2/0 0 1	3 3,5 4	70 cm 70 cm 70 cm	24 24 24
 HR 30	17281394	violet	3/0	2	70 cm	24
 HR 37s	17281655 17281658 17281664	violet violet violet	2/0 0 1	3 3,5 4	70 cm 70 cm 70 cm	24 24 24
 HR 43	17281769 17281760	violet violet	2/0 1	3 4	90 cm 70 cm	24 24
 HR 43s	17281780 17281784	violet violet	0 1	3,5 4	90 cm 90 cm	24 24
 HR 48s	17281921 17281925	violet violet	1 2	4 5	90 cm 90 cm	24 24
 HRT 17	17282201 17282206 17282212 17282216	violet violet violet violet	5/0 4/0 3/0 2/0	1 1,5 2 3	70 cm 70 cm 70 cm 70 cm	24 24 24 24
 HRT 26	17282313	violet	2/0	3	70 cm	24

PCL

absorbable
monofilament, coated







Needled sutures

Needle description	Article-No.	Colour	USP	EP	Length	UoS
 DR 12	17282621 17282625	violet violet	6/0 5/0	0,7 1	70 cm 70 cm	24 24
 2xDR 12	17282654	violet	4/0	1,5	70 cm	24
 DRT 12	17282782	violet	5/0	1	70 cm	24
 2xDRT 12	17282821 17282826	violet violet	6/0 5/0	0,7 1	70 cm 70 cm	24 24
 DS 16	17283000	violet	5/0	1	45 cm	24
 DS 19	17283021 17283028 17283047 17283051	violet violet violet violet	4/0 3/0 4/0 3/0	1,5 2 1,5 2	45 cm 45 cm 70 cm 70 cm	24 24 24 24
 DS 24	17283192 17283196	violet violet	4/0 3/0	1,5 2	70 cm 70 cm	24 24
 DSM 13	17283313 17283316	violet violet	5/0 4/0	1 1,5	45 cm 45 cm	24 24
 DSM 16	17283431 17283436	violet violet	5/0 4/0	1 1,5	45 cm 45 cm	24 24
 DSM 19	17283544 17283560	violet violet	4/0 4/0	1,5 1,5	45 cm 70 cm	24 24

PCL – Special Products

absorbable
monofilament, coated



Needled sutures

Needle description	Article-No.	Colour	USP	EP	Length	UoS
 DSM 24	17283582	violet	2/0	3	70 cm	24
 HS 30	17283862	violet	0	3,5	70 cm	24
 HS 37	17283875	violet	1	4	70 cm	24
 2xGR 19	17283920	violet	4/0	1,5	45 cm	24
 2xGR 65	17283944	violet	0	3,5	70 cm	24
 FR 27	17283941	violet	0	3,5	70 cm	24

PCL

absorbable
monofilament, coated

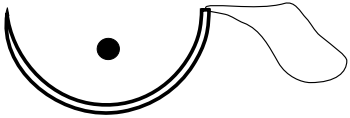
Loop sutures

Needle description	Article-No.	Colour	USP	EP	Length	UoS
 HR 43s	17284270	violet	1	4	150 cm	12
 HR 48s	17284398 17284400 17284404	violet violet violet	1 1 1	4 4 4	90 cm 150 cm 180 cm	12 12 12









Pretied ligating loop

	Article-No.	Colour	USP	EP		UoS
	17284666	violet	3/0	2		12
	17284670	violet	2/0	3		12
	17284674	violet	0	3,5		12
	17284679	violet	1	4		12

MARISORB®

absorbable
monofilament



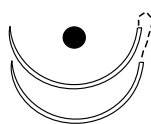





Needled sutures

Needle description	Article-No.	Colour	USP	EP	Length	UoS
 HR 13	17301035	violet	6/0	0,7	70 cm	24
	17301040	violet	5/0	1	70 cm	24
	17301044	violet	4/0	1,5	70 cm	24
	17301048	violet	3/0	2	70 cm	24
	17301052	violet	2/0	3	70 cm	24
 2xHR 13	17301094	violet	5/0	1	70 cm	24
 HR 17	17301174	violet	6/0	0,7	70 cm	24
	17301179	violet	5/0	1	70 cm	24
	17301183	violet	4/0	1,5	70 cm	24
	17301187	violet	3/0	2	70 cm	24
 HR 17s	17301199	violet	3/0	2	70 cm	24
	17301201	violet	2/0	3	70 cm	24
 2xHR 17	17301229	violet	3/0	2	90 cm	24
	17301232	violet	2/0	3	90 cm	24
	17301219	violet	4/0	1,5	70 cm	24
 HR 22	17301258	violet	4/0	1,5	70 cm	24
	17301299	violet	4/0	1,5	90 cm	24
	17301260	violet	3/0	2	70 cm	24
	17301264	violet	2/0	3	70 cm	24
	17301270	violet	0	3,5	70 cm	24
 HR 22s	17301355	violet	2/0	3	70 cm	24
	17301357	violet	0	3,5	70 cm	24
 HR 26	17301370	violet	4/0	1,5	70 cm	24
	17301372	violet	3/0	2	70 cm	24
	17301374	violet	2/0	3	70 cm	24
	17301376	violet	0	3,5	70 cm	24
 2xHR 26	17301400	violet	4/0	1,5	70 cm	24
	17301402	violet	3/0	2	70 cm	24
	17301404	violet	2/0	3	70 cm	24
	17301406	violet	0	3,5	70 cm	24

MARISORB®

absorbable
monofilament











Needled sutures

Needle description	Article-No.	Colour	USP	EP	Length	UoS
 HR 27s	17301540	violet	2/0	3	70 cm	24
	17301542	violet	0	3,5	70 cm	24
	17301545	violet	1	4	70 cm	24
 HR 30	17301600	violet	3/0	2	70 cm	24
 HR 37s	17301656	violet	2/0	3	70 cm	24
	17301670	violet	0	3,5	70 cm	24
	17301672	violet	1	4	70 cm	24
	17301701	violet	1	4	90 cm	24
 HR 43	17301772	violet	2/0	3	90 cm	24
	17301774	violet	0	3,5	90 cm	24
	17301760	violet	1	4	70 cm	24
	17301776	violet	1	4	90 cm	24
 HR 43s	17301790	violet	0	3,5	90 cm	24
	17301793	violet	1	4	90 cm	24
 HR 48s	17301931	violet	1	4	90 cm	24
	17301933	violet	2	5	90 cm	24
 HRT 17	17302200	violet	5/0	1	70 cm	24
	17302204	violet	4/0	1,5	70 cm	24
	17302205	violet	3/0	2	70 cm	24
	17302209	violet	2/0	3	70 cm	24
 HRT 26	17302310	violet	2/0	3	70 cm	24

MARISORB®

absorbable
monofilament









Needled sutures

Needle description	Article-No.	Colour	USP	EP	Length	UoS
 2xDR 10	17302540	violet	6/0	0,7	70 cm	24
 DR 12	17302632 17302644 17302645	violet violet violet	6/0 6/0 5/0	0,7 0,7 1	45 cm 70 cm 70 cm	24 24 24
 2xDR 12	17302658 17302660	violet violet	6/0 4/0	0,7 1,5	70 cm 70 cm	24 24
 DS 12	17302881 17302882	violet violet	5/0 4/0	1 1,5	45 cm 45 cm	24 24
 2xDS 12	17302914 17302916	violet violet	6/0 5/0	0,7 1	70 cm 70 cm	24 24
 DS 16	17303002 17303004	violet violet	5/0 3/0	1 2	45 cm 45 cm	24 24
 DS 19	17303035 17303037 17303055 17303059	violet violet violet violet	4/0 3/0 4/0 3/0	1,5 2 1,5 2	45 cm 45 cm 70 cm 70 cm	24 24 24 24
 DS 24	17303180 17303184	violet violet	4/0 3/0	1,5 2	70 cm 70 cm	24 24
 DSM 13	17303312 17303314 17303316	violet violet violet	5/0 4/0 3/0	1 1,5 2	45 cm 45 cm 45 cm	24 24 24
 DSM 16	17303421 17303422	violet violet	5/0 4/0	1 1,5	45 cm 45 cm	24 24
 DSM 19	17303529 17303535	violet violet	4/0 4/0	1,5 1,5	45 cm 70 cm	24 24

MARISORB®

absorbable
monofilament

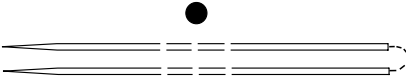
Needled sutures

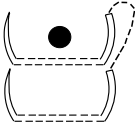
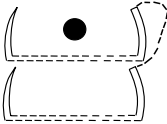
Needle description	Article-No.	Colour	USP	EP	Length	UoS
 DSM 24	17303570	violet	2/0	3	70 cm	24
 HS 12	17303668	violet	5/0	1	45 cm	24
 HS 30	17303711 17303713	violet violet	0 1	3,5 4	70 cm 70 cm	24 24
 HS 37	17303751	violet	1	4	70 cm	24
 HS 40	17303779	violet	1	4	70 cm	24
 2xGR 19	17303825	violet	4/0	1,5	45 cm	24
 2xGR 65	17303849 17303852	violet violet	0 1	3,5 4	70 cm 70 cm	24 24
 FR 27	17303880	violet	0	3,5	70 cm	24
 2xFR 27	17303910 17303914	violet violet	3/0 2/0	2 3	70 cm 90 cm	24 24
 2xFR 36	17303950	violet	2/0	3	70 cm	24

MARISORB®

absorbable
monofilament

Loop sutures

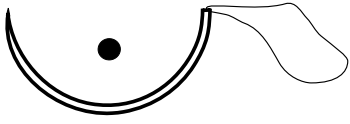
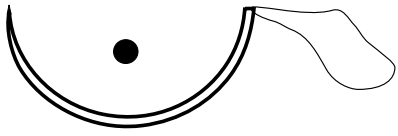
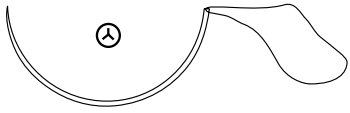
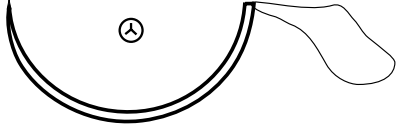
Needle description	Article-No.	Colour	USP	EP	Length	UoS
 HR 43s	17304222 17304224	violet violet	0 1	3,5 4	150 cm 150 cm	12 12
 HR 48s	17304335 17304340 17304351	violet violet violet	1 1 1	4 4 4	90 cm 150 cm 180 cm	12 12 12
 HRT 43	17304441	violet	1	4	150 cm	12
 HRT 48s	17304462	violet	1	4	150 cm	12

Pretied ligating loop









	Article-No.	Colour	USP	EP		UoS
	17304781 17304782	violet violet	0 1	3,5 4		12 12

MARICRYL®

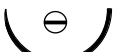
undyed

Poly(glycolide-co-caprolactone)
monofilament, fast absorbable

Needled sutures





Needle description	Article-No.	USP	EP	Length	UoS
 HR 17	17221134 17221138	4/0 3/0	1,5 2	70 cm 70 cm	24 24
 HR 22	17221194 17221197 17221200	4/0 3/0 2/0	1,5 2 3	70 cm 70 cm 70 cm	24 24 24
 Blackline HRB 22f	17221469	3/0	2	70 cm	24
 HR 26	17221501 17221503 17221506 17221525	4/0 3/0 2/0 3/0	1,5 2 3 2	70 cm 70 cm 70 cm 90 cm	24 24 24 24
 Blackline HRB 26f	17221612	3/0	2	70 cm	24
 DS 12	17223258	4/0	1,5	70 cm	24
 DS 16	17223290	4/0	1,5	70 cm	24
 DS 19	17223350 17223351 17223362 17223364	4/0 3/0 4/0 3/0	1,5 2 1,5 2	45 cm 45 cm 70 cm 70 cm	24 24 24 24
 DS 24	17223399 17223400 17223404	4/0 3/0 2/0	1,5 2 3	70 cm 70 cm 70 cm	24 24 24

MARICRYL®

undyed

Poly(glycolide-co-caprolactone)
monofilament, fast absorbable

Needled sutures

Needle description	Article-No.	USP	EP	Length	UoS
 DSM 13	17223593 17223594	5/0 4/0	1 1,5	45 cm 45 cm	24 24
 DSM 19	17223651 17223653	4/0 3/0	1,5 2	45 cm 45 cm	24 24
 DSM 24	17223699 17223701	3/0 2/0	2 3	70 cm 70 cm	24 24
 GR 19	17224201	4/0	1,5	70 cm	24

MARICRYL®

undyed







Poly(glycolide-co-caprolactone)
monofilament, fast absorbable

Ligatures

	Article-No.	USP	EP	Length	UoS
	17220109 17220110	3/0 2/0	2 3	3x45 cm 3x45 cm	24 24
	17220412	2/0	3	2x70 cm	24



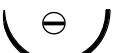



MARICRYL®**violet**Poly(glycolide-co-caprolactone)
monofilament, fast absorbable

Needled sutures

Needle description	Article-No.	USP	EP	Length	UoS
 HR 13	17226091	5/0	1	70 cm	24
 HR 17	17226131 17226135	5/0 4/0	1 1,5	70 cm 70 cm	24 24
 Blackline HRB 17f	17226163 17226172	4/0 4/0	1,5 1,5	70 cm 90 cm	24 24
 HR 22	17226195 17226198	4/0 3/0	1,5 2	70 cm 70 cm	24 24
 HR 22	17229695	3/0	2	4x70 cm	24
 Blackline HRB 22f	17226470	3/0	2	70 cm	24
 Blackline 2xHRB 22f	17226486 17226487	4/0 3/0	1,5 2	90 cm 90 cm	24 24
 HR 26	17226504	3/0	2	70 cm	24

MARICRYL®**violet**Poly(glycolide-co-caprolactone)
monofilament, fast absorbable









Needled sutures

Needle description	Article-No.	USP	EP	Length	UoS
 Blackline HRB 26f	17226613 17226615	3/0 2/0	2 3	70 cm 70 cm	24 24
 Blackline 2xHRB 26f	17226633 17226635 17226641	3/0 2/0 3/0	2 3 2	70 cm 70 cm 90 cm	24 24 24
 HS 20	17226771	3/0	2	70 cm	24
 DS 19	17228352	3/0	2	45 cm	24
 DSM 13	17228592 17228594	6/0 5/0	0,7 1	45 cm 45 cm	24 24
 DSM 19	17228652 17228654	4/0 3/0	1,5 2	45 cm 45 cm	24 24

Polyester-S green

non-absorbable
braided, coated









Needled sutures

Needle description	Article-No.	USP	EP	Length	UoS
 HR 10	17212855 17212863	6/0 5/0	0,7 1	70 cm 70 cm	24 24
 2xHR 10	17212871 17212880	6/0 5/0	0,7 1	70 cm 70 cm	24 24
 HR 13	17212898 17212901	5/0 4/0	1 1,5	70 cm 70 cm	24 24
 2xHR 13	17212910 17212928	5/0 4/0	1 1,5	70 cm 70 cm	24 24
 HR 17	17212936 17212944 17212952 17218759	5/0 4/0 3/0 2/0	1 1,5 2 3	70 cm 70 cm 70 cm 70 cm	24 24 24 24
 2xHR 17	17212960 17212979 17212987 17212995 17213002 17213010	5/0 4/0 3/0 5/0 4/0 3/0	1 1,5 2 1 1,5 2	70 cm 70 cm 70 cm 90 cm 90 cm 90 cm	24 24 24 24 24 24
 HR 17s	17212933	4/0	1,5	70 cm	24
 HR 22	17213029 17213037	3/0 2/0	2 3	70 cm 70 cm	24 24
 2xHR 22	17213045 17213053 17213061 17213070	3/0 2/0 3/0 2/0	2 3 2 3	70 cm 70 cm 90 cm 90 cm	24 24 24 24

Polyester-S green

non-absorbable
braided, coated









Needled sutures

Needle description	Article-No.	USP	EP	Length	UoS
 HR 26	17216737	4/0	1,5	70 cm	24
	17213088	3/0	2	70 cm	24
	17213096	2/0	3	70 cm	24
	17213100	0	3,5	70 cm	24
	17213118	1	4	70 cm	24
 2xHR 26	17213126	3/0	2	70 cm	24
	17213134	3/0	2	90 cm	24
	17213142	2/0	3	90 cm	24
	17213150	0	3,5	90 cm	24
 HR 27s	17219847	5	7	70 cm	24
 HR 30	17213169	4/0	1,5	70 cm	24
	17218457	3/0	2	70 cm	24
	17213177	2/0	3	70 cm	24
	17213185	0	3,5	70 cm	24
	17213193	1	4	70 cm	24
	17213207	2	5	70 cm	24
	17213208	2	5	90 cm	24
 HR 37	17213215	2/0	3	70 cm	24
	17213223	0	3,5	70 cm	24
	17213231	1	4	70 cm	24
	17213240	2	5	70 cm	24
 HR 65	17217180	4	6	70 cm	24
 HRT 17	17219418	5/0	1	70 cm	24
	17219422	4/0	1,5	70 cm	24
	17218934	3/0	2	70 cm	24
 HRT 37	17219616	2	5	70 cm	24

Polyester-S green

non-absorbable
braided, coated









Needled sutures

Needle description	Article-No.	USP	EP	Length	UoS
 DS 12	17213258	6/0	0,7	70 cm	24
	17213266	5/0	1	70 cm	24
	17213274	4/0	1,5	70 cm	24
 2xDS 12	17213282	5/0	1	70 cm	24
	17213290	4/0	1,5	70 cm	24
 DS 16	17213304	6/0	0,7	70 cm	24
	17218596	5/0	1	70 cm	24
	17213312	4/0	1,5	70 cm	24
	17213320	3/0	2	70 cm	24
 DS 19	17217466	4/0	1,5	45 cm	24
	17217470	3/0	2	45 cm	24
	17213339	5/0	1	70 cm	24
	17217350	4/0	1,5	70 cm	24
	17213347	3/0	2	70 cm	24
	17213355	2/0	3	70 cm	24
 2xDS 19	17213363	3/0	2	70 cm	24
 DS 24	17217458	3/0	2	45 cm	24
	17219894	2/0	3	45 cm	24
	17219896	0	3,5	45 cm	24
	17213371	4/0	1,5	70 cm	24
	17213380	3/0	2	70 cm	24
	17213398	2/0	3	70 cm	24
 DS 30	17219902	0	3,5	45 cm	24
	17217369	3/0	2	70 cm	24
	17213401	2/0	3	70 cm	24
	17213410	0	3,5	70 cm	24
 DS 39	17213428	2/0	3	70 cm	24
	17213436	0	3,5	70 cm	24
	17213444	1	4	70 cm	24

Polyester-S green

non-absorbable
braided, coated



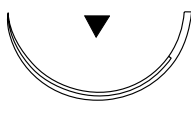



Needled sutures

Needle description	Article-No.	USP	EP	Length	UoS
 DSM 13	17219812 17219816 17219820	5/0 4/0 3/0	1 1,5 2	45 cm 45 cm 45 cm	24 24 24
 HS 9	17213452	5/0	1	70 cm	24
 HS 12	17213460	4/0	1,5	70 cm	24
 HS 15	17213479 17213483 17213490 17213487	5/0 4/0 3/0 3/0	1 1,5 2 2	70 cm 70 cm 45 cm 70 cm	24 24 24 24
 2xHS 15	17213495	3/0	2	70 cm	24
 HS 20	17213508 17213509	4/0 3/0	1,5 2	70 cm 70 cm	24 24
 HS 26	17213517 17213525 17213533	3/0 2/0 0	2 3 3,5	70 cm 70 cm 70 cm	24 24 24
 HS 30	17213541	1	4	70 cm	24
 HS 37	17213546	3	2/0	70 cm	24

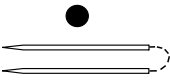
Polyester-S green

non-absorbable
braided, coated









Needled sutures

Needle description	Article-No.	USP	EP	Length	UoS
 GR 19	17213554 17213572 17213550 17213568	4/0 3/0 4/0 3/0	1,5 2 1,5 2	45 cm 45 cm 70 cm 70 cm	24 24 24 24
 2xGR 19	17213576	4/0	1,5	50 cm	24
 GS 60	17218649	2/0	3	70 cm	24
 KS 22	17218653	3/0	2	45 cm	24
 DR 10	17213584 17213592	6/0 5/0	0,7 1	70 cm 70 cm	24 24
 DR 12	17213614 17213622	5/0 4/0	1 1,5	70 cm 70 cm	24 24
 2xDR 12	17213657 17213630 17213649	4/0 5/0 4/0	1,5 1 1,5	90 cm 70 cm 70 cm	24 24 24

Polyester-S green

non-absorbable
braided, coated

Needled sutures

Needle description	Article-No.	USP	EP	Length	UoS
 DR 18	17213665	4/0	1,5	70 cm	24
 DR 20	17213673	3/0	2	70 cm	24
 2xDR 20	17213681	3/0	2	70 cm	24
 DR 26	17213690 17213703	3/0 1	2 4	70 cm 70 cm	24 24
 2x DR 26	17213711	3/0	2	70 cm	24
 DR 32	17213720	0	3,5	70 cm	24
 2xDRT 12	17219824 17219827 17219832	6/0 5/0 3/0	0,7 1 2	90 cm 90 cm 90 cm	24 24 24
 DRT 18	17219956 17216944 17216940	4/0 3/0 2/0	1,5 2 3	70 cm 70 cm 70 cm	24 24 24

Polyester-S green

non-absorbable, braided, coated

Ligatures

	Article-No.	USP	EP	Length	UoS
Ligatures	17219990	4/0	1,5	5x35 cm	24
	17219974	3/0	2	5x35 cm	24
	17219970	2/0	3	5x35 cm	24
	17219836	2	5	12x45 cm	24
	17219652	2/0	3	1x50 cm	24
	17213738	5/0	1	3x50 cm	24
	17213746	4/0	1,5	3x50 cm	24
	17213754	3/0	2	3x50 cm	24
	17213762	2/0	3	3x50 cm	24
	17213770	0	3,5	3x50 cm	24
	17213789	1	4	3x50 cm	24
	17213797	2	5	3x50 cm	24
	17213800	3	6	3x50 cm	24
	17213819	5/0	1	5x50 cm	24
	17213827	4/0	1,5	5x50 cm	24
	17213835	3/0	2	5x50 cm	24
	17213843	2/0	3	5x50 cm	24
	17213851	0	3,5	5x50 cm	24
	17213860	1	4	5x50 cm	24
	17213878	2	5	5x50 cm	24
	17213880	4	6	5x50 cm	24
	17213886	4/0	1,5	10x50 cm	24
	17213894	3/0	2	10x50 cm	24
	17213908	2/0	3	10x50 cm	24
	17213916	0	3,5	10x50 cm	24
	17213924	1	4	10x50 cm	24
	17213932	2	5	10x50 cm	24
	17218869	3	6	10x50 cm	24
	17213940	4/0	1,5	2x75 cm	24
	17213959	3/0	2	2x75 cm	24
	17213967	2/0	3	2x75 cm	24
	17213975	0	3,5	2x75 cm	24
	17213983	1	4	2x75 cm	24
	17213991	2	5	2x75 cm	24
	17214009	3	6	2x75 cm	24
	17214013	5	7	2x75 cm	24

Polyester-S green

non-absorbable, braided, coated









Ligatures

	Article-No.	USP	EP	Length	UoS
Ligatures	17218433	2/0	3	5x75 cm	24
	17216575	0	3,5	5x75 cm	24
	17216583	1	4	5x75 cm	24
	17217695	2	5	5x75 cm	24
	17218885	3	6	5x75 cm	24
	17214025	3/0	2	10x75 cm	24
	17214033	2/0	3	10x75 cm	24
	17214041	0	3,5	10x75 cm	24
	17218877	1	4	10x75 cm	24
	17214050	3/0	2	1x150 cm	24
	17214068	2/0	3	1x150 cm	24
	17214076	0	3,5	1x150 cm	24
	17214084	1	4	1x150 cm	24
	17214092	2	5	1x150 cm	24
	17214106	3	6	1x150 cm	24
	17214114	4	6	1x150 cm	24

Polyester white

non-absorbable
braided, uncoated







Needled sutures

Needle description	Article-No.	USP	EP	Length	UoS
 HR 10	17218460 17218464	6/0 5/0	0,7 1	70 cm 70 cm	24 24
 HR 17	17218468 17217091	4/0 3/0	1,5 2	70 cm 70 cm	24 24
 HR 22	17216745 17216753	3/0 2/0	2 3	70 cm 70 cm	24 24
 HR 26	17217105 17217016 17217113 17218225 17219668	3/0 2/0 0 1 0	2 3 3,5 4 3,5	70 cm 70 cm 70 cm 70 cm 90 cm	24 24 24 24 24
 HR 30	17218249 17218950 17217121	2/0 0 1	3 3,5 4	70 cm 70 cm 70 cm	24 24 24
 HR 37	17219584 17218217 17218241	0 1 2	3,5 4 5	45 cm 70 cm 70 cm	24 24 24
 DS 12	17218097 17218105	5/0 4/0	1 1,5	45 cm 45 cm	24 24
 DS 16	17218113 17218121 17219028	4/0 3/0 2/0	1,5 2 3	45 cm 45 cm 45 cm	24 24 24

Polyester white

non-absorbable
braided, uncoated

Needled sutures

Needle description	Article-No.	USP	EP	Length	UoS
 DS 19	17218297	4/0	1,5	45 cm	24
	17218313	4/0	1,5	70 cm	24
	17218073	3/0	2	45 cm	24
	17218321	3/0	2	70 cm	24
	17218081	2/0	3	45 cm	24
	17217130	2/0	3	70 cm	24
 DS 24	17218329	4/0	1,5	70 cm	24
	17218337	3/0	2	70 cm	24
	17218845	2/0	3	45 cm	24
	17218345	2/0	3	70 cm	24
	17218353	0	3,5	70 cm	24
 DS 30	17218377	3/0	2	70 cm	24
	17218385	2/0	3	70 cm	24
	17218393	0	3,5	70 cm	24
 HS 15	17218958	4/0	1,5	70 cm	24
 HS 20	17218966	4/0	1,5	70 cm	24
	17218475	3/0	2	70 cm	24
 HS 26	17216974	3/0	2	70 cm	24
	17216982	2/0	3	70 cm	24
 HS 30	17217008	1	4	70 cm	24

Polyester white

non-absorbable
braided, uncoated

Ligatures

	Article-No.	USP	EP	Length	UoS
Ligatures	17218089	2/0	3	3x35 cm	24
	17218494	0	3,5	3x35 cm	24
	17216605	4/0	1,5	5x35 cm	24
	17216613	3/0	2	5x35 cm	24
	17216621	2/0	3	5x35 cm	24
	17216630	0	3,5	5x35 cm	24
	17216648	1	4	5x35 cm	24
	17216656	2	5	5x35 cm	24
	17219978	3/0	2	10x35 cm	24
	17216699	0	3,5	1x50 cm	24
	17216702	1	4	1x50 cm	24
	17216710	2	5	1x50 cm	24
	17215960	2/0	3	3x50 cm	24
	17215978	0	3,5	3x50 cm	24
	17215986	1	4	3x50 cm	24
	17215994	2	5	3x50 cm	24
	17216001	3	6	3x50 cm	24
	17216060	3/0	2	5x50 cm	24
	17216079	2/0	3	5x50 cm	24
	17216087	0	3,5	5x50 cm	24
	17216095	1	4	5x50 cm	24
	17216109	2	5	5x50 cm	24
	17216117	3	6	5x50 cm	24
	17216168	4/0	1,5	10x50 cm	24
	17216176	3/0	2	10x50 cm	24
	17216184	2/0	3	10x50 cm	24
	17216192	0	3,5	10x50 cm	24
	17216206	1	4	10x50 cm	24
	17216214	2	5	10x50 cm	24

Polyester white

non-absorbable
braided, uncoated











Ligatures

	Article-No.	USP	EP	Length	UoS
Ligatures	17216273	4/0	1,5	2x75 cm	24
	17216281	3/0	2	2x75 cm	24
	17216290	2/0	3	2x75 cm	24
	17216303	0	3,5	2x75 cm	24
	17216311	1	4	2x75 cm	24
	17216320	2	5	2x75 cm	24
	17216338	3	6	2x75 cm	24
	17216346	4	6	2x75 cm	24
	17216354	5	7	2x75 cm	24
	17216362	6	8	2x75 cm	24
	17218671	2/0	3	5x75 cm	24
	17218673	0	3,5	5x75 cm	24
	17216788	1	4	5x75 cm	24
	17216796	2	5	5x75 cm	24
	17218604	3	6	5x75 cm	24
	17216400	2/0	3	10x75 cm	24
	17218580	1	4	10x75 cm	24
	17216443	0	3,5	1x150 cm	24
	17216451	1	4	1x150 cm	24
	17216460	2	5	1x150 cm	24

GREENFIL

Polyester green
non-absorbable
braided, uncoated

Needled sutures

Needle description	Article-No.	USP	EP	Length	UoS
 HR 22	17251066 17251072	3/0 2/0	2 3	70 cm 70 cm	24 24
 HR 26	17251113 17251117 17251134	2/0 0 2/0	3 3,5 3	70 cm 70 cm 100 cm	24 24 24
 DS 12	17251247	5/0	1	45 cm	24
 DS 16	17251271 17251278	4/0 3/0	1,5 2	45 cm 45 cm	24 24
 DS 19	17251312 17251336 17251320 17251344	3/0 3/0 2/0 2/0	2 2 3 3	45 cm 70 cm 45 cm 70 cm	24 24 24 24
 DS 24	17251400 17251404 17251376 17251384 17251392	3/0 2/0 3/0 2/0 0	2 3 2 3 3,5	45 cm 45 cm 70 cm 70 cm 70 cm	24 24 24 24 24
 DS 30	17251416 17251432 17251440 17251444	3/0 2/0 0 1	2 3 3,5 4	45 cm 70 cm 70 cm 70 cm	24 24 24 24
 DS 39	17251446 17251448	2/0 0	3 3,5	70 cm 70 cm	24 24
 HS 12	17251477	4/0	1,5	70 cm	24
 GS 60	17251900	2/0	3	70 cm	24

GREENFIL

Polyester green
non-absorbable
braided, uncoated









Ligatures

	Article-No.	USP	EP	Length	UoS
Ligatures	17250164	3/0	2	3x50 cm	24
	17250170	2/0	3	3x50 cm	24
	17250177	0	3,5	3x50 cm	24
	17250185	1	4	3x50 cm	24
	17250190	2	5	3x50 cm	24
	17250197	3	6	3x50 cm	24
	17250076	4/0	1,5	5x50 cm	24
	17250084	3/0	2	5x50 cm	24
	17250090	2/0	3	5x50 cm	24
	17250097	0	3,5	5x50 cm	24
	17250100	1	4	5x50 cm	24
	17250107	2	5	5x50 cm	24
	17250002	4/0	1,5	10x50 cm	24
	17250004	3/0	2	10x50 cm	24
	17250007	2/0	3	10x50 cm	24
	17250009	0	3,5	10x50 cm	24
	17250018	1	4	10x50 cm	24
	17250240	3/0	2	2x75 cm	24
	17250247	2/0	3	2x75 cm	24
	17250253	0	3,5	2x75 cm	24
	17250257	1	4	2x75 cm	24
	17250260	2	5	2x75 cm	24
	17250267	3	6	2x75 cm	24
	17250572	2/0	3	5x75 cm	24
	17250576	0	3,5	5x75 cm	24
	17250580	1	4	5x75 cm	24

MAPROLEN®

Polypropylene, monofilament, blue, non-absorbable







Needled sutures

Needle description	Article-No.	USP	EP	Length	UoS
 HR 10	17401023 17401034 17401038	6/0 7/0 6/0	0,7 0,5 0,7	45 cm 75 cm 75 cm	24 24 24
 2xHR 13	17401122 17401135	5/0 4/0	1 1,5	75 cm 90 cm	24 24
 HR 17	17401200	5/0	1	75 cm	24
 2xHR 17	17401240	5/0	1	90 cm	24
 Blackline HRB 17f	17401270 17401294	4/0 4/0	1,5 1,5	75 cm 90 cm	24 24
 Blackline 2xHRB 17f	17401350	4/0	1,5	90 cm	24
 Blackline HRB 22f	17401410	4/0	1,5	75 cm	24
 Blackline 2xHRB 22f	17401441	4/0	1,5	90 cm	24

MAPROLEN®

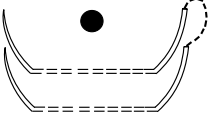
Polypropylene, monofilament, blue, non-absorbable

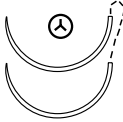

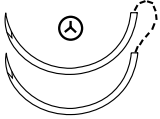





Needled sutures

Needle description	Article-No.	USP	EP	Length	UoS
 Blackline HRB 26f	17401511	4/0	1,5	75 cm	24
 Blackline 2xHRB 26f	17401542 17401544	3/0 2/0	2 3	90 cm 90 cm	24 24
 HR 27s	17401600	0	3,5	75 cm	24
 2xHR37	17401705	3/0	2	90 cm	24
 2xHRT 17	17402024	4/0	1,5	90 cm	24
 2xHRT 22	17402171	5/0	1	75 cm	24
 HRT 26	17402220	3/0	2	75 cm	24
 2xHRT 26	17402240 17402261 17402265	3/0 4/0 3/0	2 1,5 2	90 cm 120 cm 120 cm	24 24 24

MAPROLEN®

Polypropylene, monofilament, blue, non-absorbable







Needled sutures

Needle description	Article-No.	USP	EP	Length	UoS
 2xDR 6	17402481	7/0	0,5	45 cm	24
 Blackline 2xDRB 10f	17402540 17402544 17402559 17402561	7/0 6/0 7/0 6/0	0,5 0,7 0,5 0,7	75 cm 75 cm 90 cm 90 cm	24 24 24 24
 Blackline DRB 12f	17402608 17402612 17402631 17402633	6/0 5/0 6/0 5/0	0,7 1 0,7 1	45 cm 45 cm 75 cm 75 cm	24 24 24 24
 Blackline 2xDRB 12f	17402640 17402652 17402654 17402666	6/0 6/0 5/0 5/0	0,7 0,7 1 1	45 cm 75 cm 75 cm 90 cm	24 24 24 24
 Blackline 2xDRB 15f	17402698	4/0	1,5	90 cm	24
 Blackline DRB 18f	17402748 17402752 17402754	5/0 4/0 3/0	1 1,5 2	75 cm 75 cm 75 cm	24 24 24
 Blackline 2xDRB 18f	17402769 17402771	4/0 3/0	1,5 2	90 cm 90 cm	24 24
 Blackline 2xDRB 22f	17402828 17402830	4/0 3/0	1,5 2	90 cm 90 cm	24 24

MAPROLEN®

Polypropylene, monofilament, blue, non-absorbable



Needled sutures

Needle description	Article-No.	USP	EP	Length	UoS
 2xDRD 12	17402944	6/0	0,7	45 cm	24
 2xDRD 24-13	17402978	7/0	0,5	75 cm	24
 DS 12	17403101 17403112 17403114	5/0 6/0 5/0	1 0,7 1	45 cm 75 cm 75 cm	24 24 24
 2xDS 12	17403129	5/0	1	75 cm	24
 DS 16	17403144 17403146	5/0 4/0	1 1,5	75 cm 75 cm	24 24
 DS 19	17403228 17403230 17403232 17403251 17403253 17403256	5/0 4/0 3/0 5/0 4/0 3/0	1 1,5 2 1 1,5 2	45 cm 45 cm 45 cm 75 cm 75 cm 75 cm	24 24 24 24 24 24
 DS 24	17403341 17403366 17403368 17403370	3/0 4/0 3/0 2/0	2 1,5 2 3	45 cm 75 cm 75 cm 75 cm	24 24 24 24









MAPROLEN®

Polypropylene, monofilament, blue, non-absorbable









Needled sutures

Needle description	Article-No.	USP	EP	Length	UoS
 DS 30	17403486 17403490 17403492	3/0 2/0 0	2 3 3,5	75 cm 75 cm 75 cm	24 24 24
 DS 39	17403552	0	3,5	75 cm	24











MARILON®non-absorbable
blue, monofilament**Needled sutures**

Needle description	Article-No.	USP	EP	Length	UoS
 2xHR 13	17214173	6/0	0,7	70 cm	24
	17214181	5/0	1	70 cm	24
	17214190	4/0	1,5	90 cm	24
 HR 17	17214203	5/0	1	70 cm	24
	17214211	4/0	1,5	70 cm	24
	17214220	3/0	2	70 cm	24
	17219430	2/0	3	70 cm	24
 2xHR 17	17214238	5/0	1	90 cm	24
	17214246	4/0	1,5	90 cm	24
 HR 22	17214254	4/0	1,5	70 cm	24
	17214262	3/0	2	70 cm	24
	17219438	2/0	3	70 cm	24
 2xHR22	17214270	4/0	1,5	90 cm	24
	17214289	3/0	2	90 cm	24
 HR 26	17214297	3/0	2	70 cm	24
	17214300	2/0	3	70 cm	24
	17214319	0	3,5	70 cm	24
 HRT 17	17216818	5/0	1	70 cm	24
	17216826	4/0	1,5	70 cm	24
 DS 12	17214343	6/0	0,7	70 cm	24
	17214351	5/0	1	70 cm	24
	17214360	4/0	1,5	70 cm	24
 DS 16	17217022	5/0	1	45 cm	24
	17214378	5/0	1	70 cm	24
	17217024	4/0	1,5	45 cm	24
	17214386	4/0	1,5	70 cm	24
	17218893	3/0	2	70 cm	24

MARILON®non-absorbable
blue, monofilament**Needled sutures**







Needle description	Article-No.	USP	EP	Length	UoS
 DS 19	17214394	5/0	1	70 cm	24
	17217030	4/0	1,5	45 cm	24
	17214408	4/0	1,5	70 cm	24
	17217032	3/0	2	45 cm	24
	17214416	3/0	2	70 cm	24
	17214420	2/0	3	70 cm	24
 DS 24	17219559	4/0	1,5	45 cm	24
	17214424	4/0	1,5	70 cm	24
	17218861	3/0	2	45 cm	24
	17214432	3/0	2	70 cm	24
	17217040	2/0	3	45 cm	24
	17214440	2/0	3	70 cm	24
 DS 30	17214459	4/0	1,5	70 cm	24
	17214467	3/0	2	70 cm	24
	17214475	2/0	3	70 cm	24
	17214483	0	3,5	70 cm	24
 DS 39	17214491	2/0	3	70 cm	24
	17214495	0	3,5	70 cm	24
 DSM 11	17217253	5/0	1	70 cm	24
 DSM 13	17214646	5/0	1	45 cm	24
 DSM 16	17218901	4/0	1,5	45 cm	24
 DSM 19	17219312	4/0	1,5	45 cm	24
	17219316	3/0	2	45 cm	24

MARILON®non-absorbable
blue, monofilament**Needed sutures**

Needle description	Article-No.	USP	EP	Length	UoS
 DSM 24	17219319	4/0	1,5	70 cm	24
	17219300	3/0	2	45 cm	24
	17219320	3/0	2	70 cm	24
	17219680	2/0	3	70 cm	24
 DR 10	17214521	6/0	0,7	70 cm	24
 DR 12	17214564	6/0	0,7	70 cm	24
	17214572	5/0	1	70 cm	24
 2xDR 12	17214580	6/0	0,7	70 cm	24
	17214599	5/0	1	70 cm	24
 DR 15	17214610	4/0	1,5	70 cm	24
 DR 18	17214645	5/0	1	70 cm	24
	17214653	4/0	1,5	70 cm	24
	17214661	3/0	2	70 cm	24
 2xDR 18	17214670	5/0	1	90 cm	24
	17214688	4/0	1,5	90 cm	24
	17214696	3/0	2	90 cm	24
 DRT 12	17216850	6/0	0,7	70 cm	24
	17216869	5/0	1	70 cm	24
 DRT 18	17216877	4/0	1,5	70 cm	24
	17216885	3/0	2	70 cm	24
 DSS 19	17217841	4/0	1,5	45 cm	24
	17217850	3/0	2	45 cm	24
 DSS 24	17217884	3/0	2	45 cm	24
	17217892	4/0	1,5	70 cm	24
	17217899	3/0	2	70 cm	24

MARILON®
non-absorbable
blue, monofilament

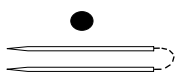
Needled sutures

Needle description	Article-No.	USP	EP	Length	UoS
 HR 27s	17219004 17219712	2/0 0	3 3,5	70 cm 70 cm	24 24
 HR 37s	17219714 17219844 17219845	0 1 1	3,5 4 4	70 cm 70 cm 90 cm	24 24 24
 HS 37	17219866 17219867	0 1	3,5 4	70 cm 70 cm	24 24
 KS 22	17219307 17219708	4/0 4/0	1,5 1,5	25 cm 40 cm	24 24
 2x GR 19	17214505	4/0	1,5	50 cm	24
 2x GR 38	17214513 17214514	3/0 3/0	2 2	50 cm 70 cm	24 24
 GS 60	17217927	3/0	2	70 cm	24

MARILON®
non-absorbable
blue, monofilament

Loops









	Article-No.	USP	EP		UoS
Pretied ligating loop	17218768 17218776	2/0 0	3 3,5		12 12

MARIDERM®

non-absorbable

Nylon, blue, monofilament

Needled sutures







Needle description	Article-No.	USP	EP	Length	UoS
 DS 12	17219776	5/0	1	45 cm	24
 DS 16	17217431 17217423 17218790	5/0 4/0 3/0	1 1,5 2	45 cm 45 cm 45 cm	24 24 24
 DS 19	17217482 17217490 17217520 17217504 17217539 17219470	5/0 4/0 4/0 3/0 3/0 2/0	1 1,5 1,5 2 2 3	45 cm 45 cm 70 cm 45 cm 70 cm 70 cm	24 24 24 24 24 24
 DS 24	17217580 17217598 17217628 17217601 17217636	4/0 3/0 3/0 2/0 2/0	1,5 2 2 3 3	45 cm 45 cm 70 cm 45 cm 70 cm	24 24 24 24 24
 DS 30	17217563 17217555 17217571 17218635	3/0 2/0 2/0 0	2 3 3 3,5	70 cm 45 cm 70 cm 45 cm	24 24 24 24
 DS 39	17219124 17219027 17219035	2/0 2/0 0	3 3 3,5	45 cm 70 cm 70 cm	24 24 24
 DSM 13	17219044 17219036	5/0 4/0	1 1,5	45 cm 45 cm	24 24
 DSM 19	17219092 17218657 17219255	4/0 3/0 3/0	1,5 2 2	45 cm 50 cm 70 cm	24 24 24
 DSM 24	17219748 17219020 17219260 17219757	4/0 3/0 3/0 2/0	1,5 2 2 3	70 cm 50 cm 70 cm 45 cm	24 24 24 24

MARIDERM®

non-absorbable

Nylon, blue, monofilament









Needled sutures

Needle description	Article-No.	USP	EP	Length	UoS
 DSS 19	17219793 17219797	4/0 3/0	1,5 2	50 cm 70 cm	24 24
 DSS 24	17219790	3/0	2	50 cm	24
 HS 20	17217415	4/0	1,5	45 cm	24
 HS 30	17218910 17219992	2/0 2/0	3 3	45 cm 90 cm	24 24
 HS 37	17219993	2/0	3	70 cm	24
 GS 51	17219171	3/0	2	45 cm	24

SILK-S, black

non-absorbable
braided, coated









Needled sutures

Needle description	Article-No.	USP	EP	Length	UoS
 HR 13	17214718	4/0	1,5	70 cm	24
 HR 17	17214726 17214734	5/0 3/0	1 2	70 cm 70 cm	24 24
 HR 22	17214742 17214750	3/0 2/0	2 3	70 cm 70 cm	24 24
 HR 26	17214785	0	3,5	70 cm	24
 DS 12	17214807 17214815	5/0 4/0	1 1,5	70 cm 70 cm	24 24
 DS 16	17214840 17214858 17214866	5/0 4/0 3/0	1 1,5 2	70 cm 70 cm 70 cm	24 24 24
 DS 19	17214874 17214882 17214890	4/0 3/0 2/0	1,5 2 3	70 cm 70 cm 70 cm	24 24 24
 DS 24	17214912 17214920	2/0 0	3 3,5	70 cm 70 cm	24 24
 DS 30	17214939 17214947	2/0 0	3 3,5	70 cm 70 cm	24 24

SILK-S, black

non-absorbable
braided, coated

Needled sutures

Needle description	Article-No.	USP	EP	Length	UoS
 HS 12	17214955	4/0	1,5	70 cm	24
 HS 15	17214963 17214971 17214980	5/0 4/0 3/0	1 1,5 2	70 cm 70 cm 70 cm	24 24 24
 HS 20	17214998	3/0	2	70 cm	24
 HS 26	17215001 17215005	3/0 3/0	2 2	45 cm 70 cm	24 24
 HS 30	17215021	1	4	70 cm	24
 GR 19	17215030 17218942	4/0 2/0	1,5 3	70 cm 70 cm	24 24
 DR 18	17219620	4/0	1,5	70 cm	24
 DR 20	17215064	3/0	2	70 cm	24

SILK-S, black
 non-absorbable
 braided, coated











Ligatures



Needle description	Article-No.	USP	EP	Length	UoS
Ligatures	17217660	4/0	1,5	1x50 cm	24
	17215110	4/0	1,5	3x50 cm	24
	17215129	3/0	2	3x50 cm	24
	17215137	2/0	3	3x50 cm	24
	17215145	0	3,5	3x50 cm	24
	17215161	2	5	3x50 cm	24
	17215188	5/0	1	5x50 cm	24
	17215196	4/0	1,5	5x50 cm	24
	17215200	3/0	2	5x50 cm	24
	17215226	0	3,5	5x50 cm	24
	17217687	4/0	1,5	4x50 cm	24
	17215250	4/0	1,5	10x50 cm	24
	17215285	0	3,5	10x50 cm	24
	17215307	4/0	1,5	2x75 cm	24
	17215315	3/0	2	2x75 cm	24
	17215331	0	3,5	2x75 cm	24
	17215340	1	4	2x75 cm	24
	17215374	3/0	2	10x75 cm	24
	17215404	4/0	1,5	1x150 cm	24
	17215412	3/0	2	1x150 cm	24
17215439	0	3,5	1x150 cm	24	



Steel wire

non-absorbable, monofilament

Needled sutures

Needle description	Article-No.	USP	EP	Length	UoS
 HR 10	17215552	5/0	1	70 cm	24
 HR 17	17215560 17215579	5/0 3/0	1 2	70 cm 70 cm	24 24
 HR 26	17215609 17215617	2/0 0	3 3,5	70 cm 70 cm	24 24
 HR 37	17215633	2/0	3	70 cm	24
 DS 12	17215650	4/0	1,5	70 cm	24
 DS 19	17215668	3/0	2	70 cm	24
 DS 24	17215676	0	3,5	70 cm	24
 DS 30	17215684	2/0	3	70 cm	24
 HS 12	17215692	4/0	1,5	70 cm	24
 HS 30	17215730	0	3,5	70 cm	24

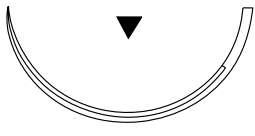

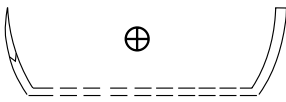

Steel wire					
non-absorbable, monofilament			Needed sutures		
Needle description	Article-No.	USP	EP	Length	UoS
 2xGR 38	17215749	3/0	2	70 cm	24
 GR 51	17215757	2/0	3	70 cm	24

Sternum wire					
non-absorbable, monofilament			Needed sutures		
Needle description	Article-No.	USP	EP	Length	UoS
 4xHS 48	17218560	5	7	45 cm	3
 4xHS 58	17217737 17217745	5 6	7 8	45 cm 45 cm	3 3
 4xHRT 58	17219328	5	7	45 cm	3

Steel wire

non-absorbable, polyfilament

Needled sutures

Needle description	Article-No.	USP	EP	Length	UoS
 DS 19	17215790	4/0	1,5	70 cm	24
 DS 24	17215811	3/0	2	70 cm	24
 DS 30	17215820	2/0	3	70 cm	24
 2xGR 38	17215846	3/0	2	70 cm	24
 2xGR 51	17215862	2/0	3	50 cm	24

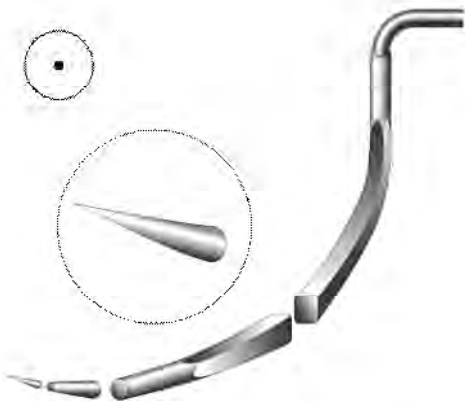

Round body needle, micro point

HRM, DR

micro needle with precision point

Application:

heart and vascular surgery
neurology
pediatry
general surgery
urology

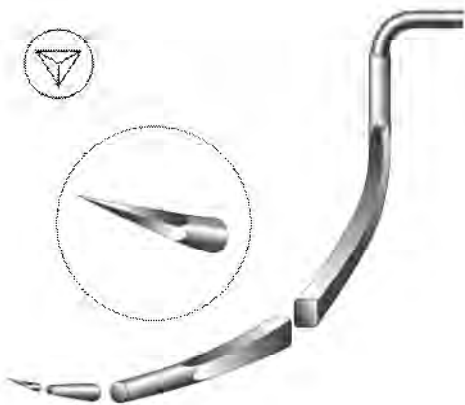

Round body needle, trocar point

HRT, DRT, VRT

micro needle with precision point and additionally polished trocar sides

Application:

heart and vascular surgery
hand surgery
neurology
urology
orthopaedics



Spatulated needle, lancet micro point

VLM, DLM, HLM, GLM, JLM

micro needle with cutting precision lancet micro point

Application:

ohthalmology and microsurgery

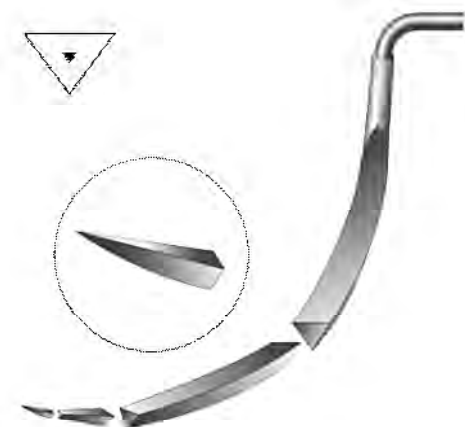

Cutting triangular needle, micro point











DSM

micro needle with triangular cross section, outside cutting edge and triangular micro point











Application:

dental surgery
pediatry
ophthalmology and plastic surgery



Surgical suture materials for MICROSURGERY & OPHTHALMOLOGY

MARLIN® (PGA) absorbable, braided, coated, violet					
Needle description	Article-No.	USP	EP	Length	UoS
 DLM 15-5	18040711	10/0 monofil	0,2	45 cm	12
 DLM 15-6	18040936 18040947	10/0 monofil 8/0	0,2 0,4	20 cm 45 cm	12 12
 DLM 20-6	18041490 18041497 18041499 18041511	8/0 7/0 7/0 6/0	0,4 0,5 0,5 0,7	30 cm 45 cm 30 cm 30 cm	12 12 12 12
 2xDLM 20-6	18041599 18041606 18041609	8/0 7/0 7/0	0,4 0,5 0,5	30 cm 45 cm 30 cm	12 12 12
 DLM 24-8	18041861	7/0	0,5	45 cm	12
 DLM 28-10	18041910	7/0	0,5	15 cm	12
 2xHLM 20-6	18043220	8/0	0,4	20 cm	12
 DSM 20-8	18044570	6/0	0,7	30 cm	12
 2xDSM 20-8	18044577	6/0	0,7	45 cm	12
 DSM 33-10	18044781	6/0	0,7	45 cm	12









Surgical suture materials for MICROSURGERY & OPHTHALMOLOGY

MARLIN® (PGA) absorbable, braided, coated		violet			
Needle description	Article-No.	USP	EP	Length	UoS
 2xDRT 20-7	18046780 18046792	8/0 7/0	0,4 0,5	30 cm 45 cm	12 12
 DRM 15-6	18049047 18049056	8/0 8/0	0,4 0,4	45 cm 20 cm	12 12
 DRM 28-10	18049481	6/0	0,7	45 cm	12
 HRM 15-6	18049837	10/0 monofil	0,2	15 cm	12
 HRM 15-8	18049957	8/0	0,4	45 cm	12
 HRM 20-6	18050333	8/0	0,4	30 cm	12
 2xVLM 28-8	18051170 18051172	6/0 6/0	0,7 0,7	40 cm 30 cm	12 12
 VLM 28-8	18051150	7/0	0,5	15 cm	12
 2xVLM 33-8	18051341 18051540	6/0 5/0	0,7 1	45 cm 45 cm	12 12
 VLM 33-8	18051400 18051407 18051505 18051508	6/0 6/0 5/0 5/0	0,7 0,7 1 1	45 cm 30 cm 45 cm 30 cm	12 12 12 12
 2xVLM 43-8	18051601	4/0	1,5	45 cm	12

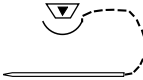









Surgical suture materials for MICROSURGERY & OPHTHALMOLOGY

MARLIN® (PGA) absorbable, braided, coated		undyed			
Needle description	Article-No.	USP	EP	Length	UoS
 HLM 20-8	18062854	6/0	0,7	45 cm	12
 2xHLM 20-8	18062990	6/0	0,7	45 cm	12
 2xVLM 33-8	18071642 18071650	6/0 5/0	0,7 1	45 cm 45 cm	12 12









Surgical suture materials for MICROSURGERY & OPHTHALMOLOGY

MAPROLEN® (Polypropylene) non-absorbable, monofilament, blue					
Needle description	Article-No.	USP	EP	Length	UoS
 DLM 20-6	18271089	8/0	0,4	30 cm	12
 2xGLM 15-16	18271755	10/0	0,2	30 cm	12 12 12
 DLM15-6 + GLM15-16	18271851	10/0	0,2	10 cm	12
 2xDRM 15-6	18279160 18279170	9/0 8/0	0,3 0,4	45 cm 45 cm	12 12
 2xDRM 28-10	18279531	5/0	1	75 cm	12
 DSM 20-8	18274409	7/0	0,5	45 cm	12
 2xHRM 20-6	18270385	7/0	0,5	45 cm	12
 2xDRC 20-9	18272248 18272254	7/0 6/0	0,5 0,7	45 cm 75 cm	12







Surgical suture materials for MICROSURGERY & OPHTHALMOLOGY

MARILON® (PVDF) non-absorbable, monofilament, blue					
Needle description	Article-No.	USP	EP	Length	UoS
 DLM 15-5	18080734	10/0	0,2	30 cm	12
 2xDLM 15-5	18080844	10/0	0,2	30 cm	12
 2xDLM 15-6	18081089 18081105 18081111	7/0 6/0 6/0	0,5 0,7 0,7	45 cm 75 cm 45 cm	12 12 12
 DLM 20-6	18081450 18081459 18081475 18081491	10/0 9/0 8/0 7/0	0,2 0,3 0,4 0,5	45 cm 45 cm 30 cm 30 cm	12 12 12 12
 2xDLM 20-6	18081523 18081531 18081540 18081550	10/0 9/0 8/0 7/0	0,2 0,3 0,4 0,5	45 cm 45 cm 45 cm 45 cm	12 12 12 12
 GLM 15-16	18091720 18091727 18091732	10/0 10/0 9/0	0,2 0,2 0,3	45 cm 15 cm 45 cm	12 12 12
 2xGLM 15-16	18091756	10/0	0,2	30 cm	12
 DRT 7-4	18085525	10/0	0,2	10 cm	12
 DRT 7-5	18085625 18085640	11/0 10/0	0,1 0,2	45 cm 15 cm	12 12
 2xDRT 20-7	18086725 18086730	7/0 7/0	0,5 0,5	70 cm 45 cm	12 12











Surgical suture materials for MICROSURGERY & OPHTHALMOLOGY

MARILON® (PVDF) non-absorbable, monofilament, blue					
Needle description	Article-No.	USP	EP	Length	UoS
 2xDRT 20-10	18086935 18086952	7/0 6/0	0,5 0,7	60 cm 75 cm	12 12
 2xDRT 28-13	18086990	7/0	0,5	70 cm	12
 DRM 7-4	18088213 18088221 18088229 18088230	11/0 10/0 10/0 10/0	0,1 0,2 0,2 0,2	45 cm 45 cm 12 cm 10 cm	12 12 12 12
 DRM 10-5	18088540 18088547	10/0 9/0	0,2 0,3	15 cm 12 cm	12 12
 DRM 15-6	18089080 18089085 18089100 18089101	10/0 9/0 8/0 8/0	0,2 0,3 0,4 0,4	15 cm 30 cm 20 cm 15 cm	12 12 12 12
 2xDRM 15-6	18089173	8/0	0,4	70 cm	12
 2xDRM 20-6	18089382	6/0	0,7	75 cm	12
 DRM 20-10	18089452 18089459 18089461	7/0 7/0 6/0	0,5 0,5 0,7	70 cm 15 cm 75 cm	12 12 12
 2xDRM 20-10	18089468 18089470 18089473	7/0 7/0 7/0	0,5 0,5 0,5	60 cm 45 cm 8 cm	12 12 12

Surgical suture materials for MICROSURGERY & OPHTHALMOLOGY

MARIDERM® (Polyamid 6.6/ Nylon) non-absorbable, monofilament, black					
Needle description	Article-No.	USP	EP	Length	UoS
 DLM 15-4	18100465	11/0	0,1	10	12
	18100473	10/0	0,2	10	12
	18100482	9/0	0,3	10	12
 DLM 15-5	18100742	11/0	0,1	30	12
	18100749	10/0	0,2	45	12
	18100751	10/0	0,2	30	12
	18100755	10/0	0,2	15	12
 2xDLM 15-5	18100849	10/0	0,2	45	12
	18100852	10/0	0,2	30	12
	18100855	10/0	0,2	15	12
 DLM 15-6	18101032	10/0	0,2	30	12
	18101036	10/0	0,2	15	12
	18101043	9/0	0,3	15	12
 2xDLM 15-6	18101103	10/0	0,2	30	12
	18101105	10/0	0,2	20	12
	18101107	10/0	0,2	15	12
 DLM 20-6	18101623	10/0	0,2	30	12
	18101629	9/0	0,3	45	12
	18101634	9/0	0,3	15	12
	18101651	7/0	0,5	30	12
	18101660	6/0	0,7	30	12
 2xDLM 20-6	18101730	10/0	0,2	45	12
	18101739	9/0	0,3	45	12
	18101741	9/0	0,3	30	12



Surgical suture materials for MICROSURGERY & OPHTHALMOLOGY





MARIDERM® (Polyamid 6.6/ Nylon) non-absorbable, monofilament, black					
Needle description	Article-No.	USP	EP	Length	UoS
 HLM 15-5	18102472 18102476 18102484	10/0 10/0 9/0	0,2 0,2 0,3	30 10 15	12 12 12
 2xHLM 15-5	18102560	10/0	0,2	30	12
 2xHLM 15-6	18102700	10/0	0,2	30	12
 JLM 15-5	18113192	10/0	0,2	30	12
 2xJLM 15-5	18113242	10/0	0,2	30	12
 DRT 7-4	18106024	10/0	0,2	10	12
 DRT 10-5	18106343 18106346	10/0 10/0	0,2 0,2	30 15	12 12
 DRT 15-5	18106751 18106759	10/0 9/0	0,2 0,3	30 30	12 12
 DRM 5-4	18109031	11/0	0,1	10	12
 DRM 7-4	18109457 18109459 18109468 18109470	11/0 11/0 10/0 10/0	0,1 0,1 0,2 0,2	15 10 15 10	12 12 12 12
 DRM 7-5	18109569 18109580 18109583	11/0 10/0 10/0	0,1 0,2 0,2	10 15 10	12 12 12

Surgical suture materials for MICROSURGERY & OPHTHALMOLOGY







MARIDERM® (Polyamid 6.6/ Nylon) non-absorbable, monofilament, black					
Needle description	Article-No.	USP	EP	Length	UoS
☺ DRM 10-4	18109687	11/0	0,1	15	12
	18109688	11/0	0,1	10	12
☺ DRM 10-5	18109811	10/0	0,2	30	12
	18109812	10/0	0,2	20	12
	18109813	10/0	0,2	15	12
	18109815	10/0	0,2	10	12
	18109826	9/0	0,3	15	12
☺ DRM 15-6	18110482	10/0	0,2	20	12
	18110484	10/0	0,2	15	12
	18110490	9/0	0,3	20	12
	18110491	9/0	0,3	15	12
	18110500	8/0	0,4	15	12
☺ DRM 20-6	18110861	7/0	0,5	15	12
☺ HRM 10-5	18111143	10/0	0,2	30	12
☺ HRM 15-5	18111316	10/0	0,2	15	12
☺ HRM 20-6	18111973	7/0	0,5	30	12

Surgical suture materials for MICROSURGERY & OPHTHALMOLOGY

POLYESTER-S GREEN (PET) non-absorbable, braided, coated					
Needle description	Article-No.	USP	EP	Length	UoS
 VLM 33-8	18132600 18132611	6/0 5/0	0,7 1	45 cm 45 cm	12 12
 2xVLM 33-8	18132838 18132850	6/0 5/0	0,7 1	45 cm 45 cm	12 12
 2xVLM 34-8	18132861	5/0	1	25 cm	12

POLYESTER-S WHITE (PET) non-absorbable, braided, uncoated					
Needle description	Article-No.	USP	EP	Length	UoS
 2xVLM 28-8	18153291 18153310	6/0 5/0	0,7 1	25 25	12 12
 VLM 33-8	18153448 18153457 18153461	6/0 5/0 5/0	0,7 1 1	45 45 25	12 12 12
 2xVLM 33-8	18153657 18153666 18153672	6/0 5/0 5/0	0,7 1 1	45 45 25	12 12 12
 VLM 43-8	18153857 18153865	5/0 4/0	1 1,5	45 45	12 12
 2xVLM 43-8	18153900	4/0	1,5	45	12

Surgical suture materials for MICROSURGERY & OPHTHALMOLOGY

SILK-S black non-absorbable, braided, coated					
Needle description	Article-No.	USP	EP	Length	UoS
 DLM 24-6	18021844	6/0	0,7	30	12
 2xDLM 24-6	18021887	6/0	0,7	45	12
 DSM 24-6	18025050	6/0	0,7	30	12
 2xDSM 24-6	18025067	6/0	0,7	30	12
 DSM 24-8	18025099	6/0	0,7	30	12
 2xDSM 24-8	18025130	6/0	0,7	30	12
 2xVLM 33-8	18031742 18031750	6/0 5/0	0,7 1	45 45	12 12

DYNAMIC SUPPORTING SUTURE

by J. Ermisch



DYNAMIC SUPPORTING SUTURE

– by J. Ermisch –



Article number	Description	Sales unit
220120	Set Dynamic Supporting Suture <i>Content:</i> 1 x Redon pike with drainage 2 x stainless steel plates 2 x compresses 1 x stainless steel closure 1 x Allen key 7 x 2 additional compresses in each set	4 sets/box
220231	2 compresses	7 x 2 pcs./box

Description of the dynamic supporting suture

The single supporting suture consists of a plastic tube (3.3 mm diameter) with an included polyfilament polyethylene center (1 mm diameter). The supporting suture is made with the help of the Redon pike. Support is realised by stainless steel plates, padding by compresses made from polyethylene foam and fixation by a special closure.

The closing mechanism is easy to close and to open without damaging the plastic tube resp. the polyethylene center. Thus you can correct the tension of the dynamic supporting suture at any time, without additional general narcosis.

The flexible plastic tube to a large extent prevents cutting or erosion of the intestine.

After being contaminated with wound liquids the compresses can be changed easily every day in order to avoid skin macerations.

Indications:

The dynamic supporting suture is intended for complicated closures of the abdominal wall. It is used for closing septic and aseptic wound dehiscences and for ventral stabilisation of the abdominal wall.

Suture technique

After opening the suture set you first put the steel plate on the tube. Please take care that the supporting side of the stainless steel plate is directed towards the abdominal wall.

You lay the suture with the help of the Redon pike by stitching in about 3 cm laterally from the outer wound edge and stitching out about 0.5 cm laterally from the inner wound edge into the direction of the laparotomic wound. The supporting suture goes out on the opposite side in opposite direction. Then you add the second plate, pad with polyethylene foam compresses and fix the suture with the special closure.

The distance between the plates should be less than one cm in order to achieve an optimum pressure distribution, i.e. you should make the maximum number of supporting sutures depending on the wound size.

Additional palisades or silicone wave drainages® (Willy Rüsçh AG) under the supporting suture allow a tension-free half-open closure of the abdominal wall for complicated septic cases.

After reducing the oedema of abdominal and intestinal wall, intestinal distension and intraabdominal pressure you can step by step approach the wound edges by changing the tension of the supporting sutures.

You should never enforce the closure of the abdominal wall with a higher tension of the supporting suture.

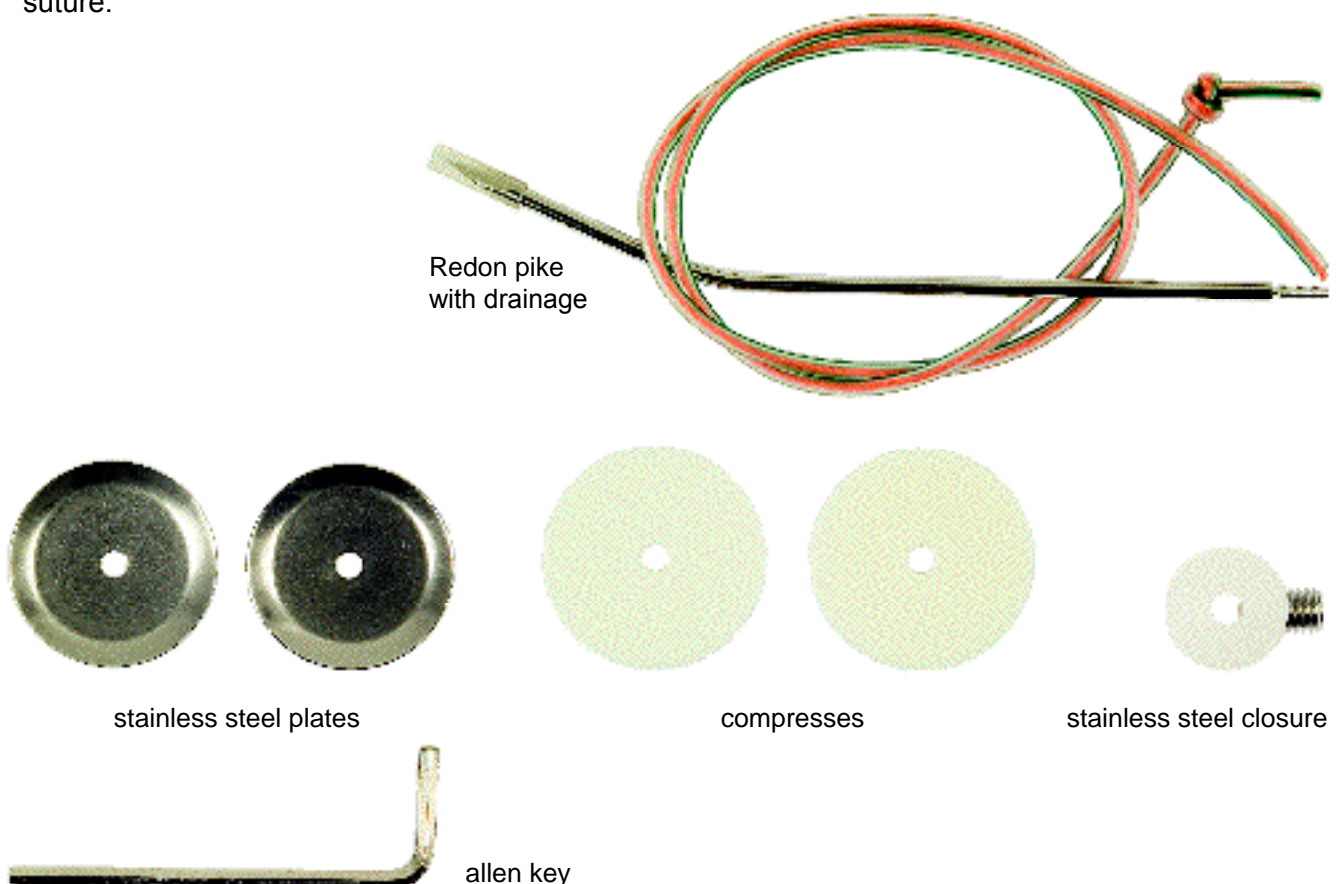

CERVIX - SET



CERVIX-SET

Embracing and suturing of cervix uteri in cases of cervix insufficiency

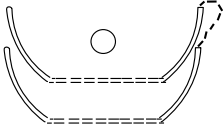
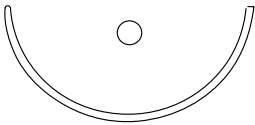
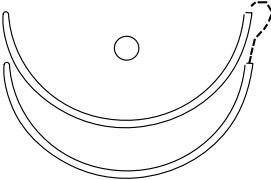
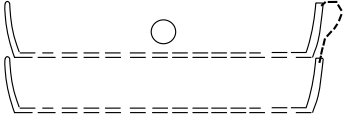
Needle description	Article-No.	Colour	Width	Length	UoS
Polyestertape white			Needled tape sutures		
 <p>2xHRN 40</p>	210240	white	3 mm	40 cm	6
 <p>HRN 50</p>	210150	white	3 mm	50 cm	6
 <p>2xHRN 50</p>	210250	white	3 mm	40 cm	6
 <p>2xHRN 65</p>	210265	white	3 mm	40 cm	6

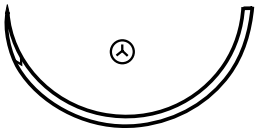
Polyester-S green, braided, coated			Needled sutures			
Needle description	Article-No.	Colour	USP	EP	Length	UoS
 <p>HRT 48s</p>	210548	green	5	7	75 cm	6

Needle Sets and Accessories

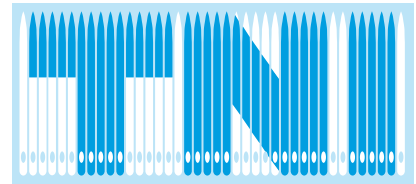

**Needle set for suture of tendons
in accordance with BUNNELL, sterilized.**

5390/1 BUNNELL for adults	▲
5391/2 BUNNELL for children	▲

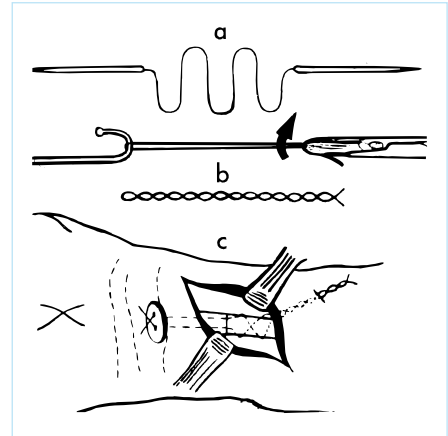

**Needle set for suture of tendons
in accordance with LENGEMANN, sterilized.**

5380/1 LENGEMANN for adults	▲
5381/2 LENGEMANN for children	▲

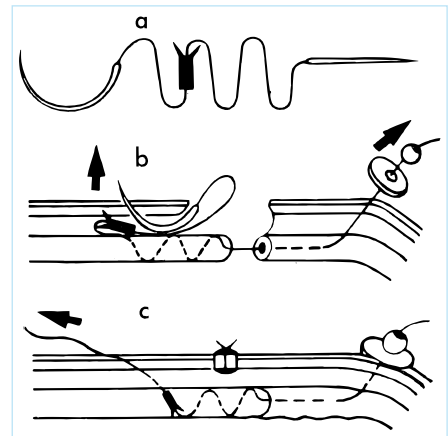

Surgical needles for tension banding.

5964	●		6-er Set
5934	●		6-er Set

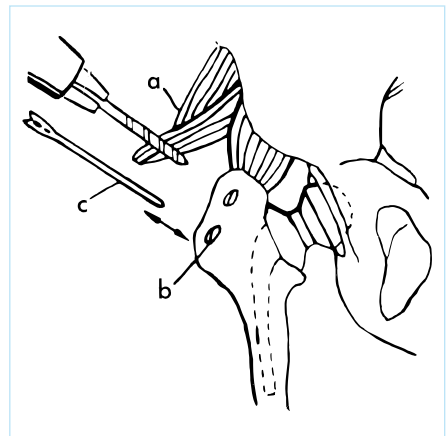
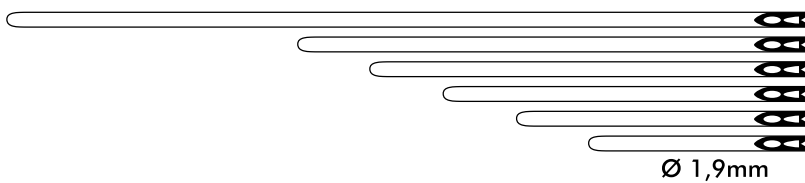

Polyestertape white braided, uncoated, non-absorbable			
Width	Length	Article-No.	UoS
3 mm	60 cm	17216800	24
6 mm	60 cm	17216893	24
6 mm	90 cm	17218641	24
8 mm	60 cm	17216907	24

Polyestertape green braided, uncoated, non-absorbable			
Width	Length	Article-No.	UoS
4,5 mm	75 cm	17219858	24

LOOPS



Loops

– for fast marking of arterias, veins, tendons and urethras

Loops

– available in four different colours.

The different colours allow quick identification during the intervention
Arterias are marked red, veins blue, tendons white and urethras yellow.

Loops

– available in different sizes, two pieces packed sterile in one foil.

The box fits into the suture cabinet.

	Artikel-No.	Description	Dimension	Length
LOOPS	230131	Loop red	1,3 x 0,9 mm	2 x 45 cm
	230133	Loop blue	1,3 x 0,9 mm	2 x 45 cm
	230134	Loop yellow	1,3 x 0,9 mm	2 x 45 cm
	230136	Loop white	1,3 x 0,9 mm	2 x 45 cm
	230241	Loop red	2,4 x 1,15 mm	2 x 45 cm
	230243	Loop blue	2,4 x 1,15 mm	2 x 45 cm
	230244	Loop yellow	2,4 x 1,15 mm	2 x 45 cm
	230246	Loop white	2,4 x 1,15 mm	2 x 45 cm
	230252	Loop red	2,4 x 1,15 mm	2 x 75 cm
	230254	Loop blue	2,4 x 1,15 mm	2 x 75 cm
	230256	Loop yellow	2,4 x 1,15 mm	2 x 75 cm
	230257	Loop white	2,4 x 1,15 mm	2 x 75 cm
	230472	Loop red	4,7 x 1,3 mm	2 x 45 cm
	230474	Loop blue	4,7 x 1,3 mm	2 x 45 cm
	230476	Loop yellow	4,7 x 1,3 mm	2 x 45 cm
	230478	Loop white	4,7 x 1,3 mm	2 x 45 cm

Contents: Box 24 à two loops

Manufacturer

MBP MEDICAL
BIOMATERIAL PRODUCTS
GmbH
Neustadt-Glewe



Gewerbepark 18
Postfach 10002
Telefon: (037422) 583-0
Telefax: (037422) 583-39

08254 Markneukirchen
Germany
e-mail: catgut@catgut.de
Internet: www.catgut.de

Tubes

NEW TYPE ILEUS DECOMPRESSION TUBE by J. Ermisch

in two versions:

Small intestine tube (Article-No. 200100)

Consisting of a silicon tube with gelatine guide head.

The silicon tube is equipped with an x-ray contrast stripe. Its holes guarantee an optimum decompression of the small intestine because of their size and position.

Silicon tube dimensions: length: 3 m, outer diameter: 6 mm

Colonic tube (Article-No. 200111)

Consisting of a silicon tube with gelatine guide head.

Its holes guarantee an optimum decompression of the colon because of their size and position.

Silicon tube dimensions: length: 1.5 m, outer diameter: 9 mm

To support transoral respectively transanal intubation a glass fibre mandrin of 80 cm length is inserted into the silicon tube before starting the procedure.

Small intestine tube

Five steps of the surgical treatment of the small intestine ileus:

1. Optimum resection of the intestine distension
2. Complete elimination of toxic ileus secretion
3. Removal of the cause of ileus
4. Prevention of Kompartment syndrom
5. Avoiding of ileus relapses

Closed decompression is basically preferred for the removal of distension.

It is sufficiently known that manual decompression according to KORN is inefficient and usual ileus tubes are difficult to handle with progressing or complicated ileus pictures.

The development of a new Ileus decompression tube substantially optimised the efficiency of closed decompression as well as the operativ-tactical procedure.



Small intestine tube with inserted mandrin and fixation clip; tube length 3 m, outer diameter 6 mm

Advantages of the ileus decompression tube:

1. Secure and fast passing of the duodenum, quick atraumatic decompression and elimination of toxic ileus secretion
2. No risk of infection
3. Absorbable guide head
4. One channel system optimises sucking efficiency
5. Prevention of an abdominal compartment syndrom in the postoperative course by intraluminary drainage of the ileus
6. Prevention of early ileus recidivs
7. Special material of high biological acceptance

In the process of surgical interventions the following ileus types indicate tube application:

- postoperative early ileus resp. early ileus recidiv
- progressive mechanic primary ileus
- mixed ileus forms including peritonitis
- paralytic ileus found during operation



Intubation technique
of the small intestine
tube by using a laryngoscope

References

In Germany 40 hospitals including four university hospitals (Charité Berlin, Magdeburg, Mannheim and Jena) work with the new tube system. We could convince in particular those surgeons of the advantages of the ileus decompression tube who in the past used the intestine stabilisation with the Miller-Abott tube or Dennis tube.

Colonic tube

The colonic decompression tube was developed in analogy to the intestine tube with adopted silicon tube size and hole geometry. The absorbable gelatine guide head is the same as with the small intestine tube.

Indications for tube application:

- characteristic colonic distension found in the process of operation
- pseudo obstruction in the process of operation (Ogilvie-syndrom)
- sigma volvulus
- colon splinting resp. colon drainage



Colonic tube with inserted mandrin
tube length 1,5 m, outer diameter 9 mm

Intestinal tube for babies and infants

for prograde resp. retrograde intestinal stabilization according to J. Ermisch



pict. 1

The intestinale tube (pict. 1) created for babies and infants consists of an absorbable flexible gelatine guide head and a silicone tube, which is fixed on the back side of the gelatine guide head. For x-ray position control the silicone tube contains an x-ray contrast stripe. The length of the silicone tube of the intestinale tube is 1.5 meters, the outer diameter 4 mm and the inner diameter 2 mm. The silicone tube has five holes in the beginning (pict. 2) for desucking and drainage of the intestine.

Indication

- Prograde or retrograde intestine stabilization for babies with multiple small intestine atresia or multiple anastomoses
- Retrograde intestine stabilization for appendicostomy or cecostomy in cases of peritonitis, repeated adhesions or prolonged ileus.
- Retrograde intestine stabilization in cases of burdened parts of intestine to prevent a short intestine syndrome.

The decision on the indication for decompression resp. the prograde or retrograde stabilization is taken in the course of the surgery. The intestinal tube is placed after enterotomy and pure-string suture, and extruded after intestine stabilization through enterostomy or according to the Witzel-technique. By preparing the gelatine guide head in hand-warm water you can increase its flexibility.

Intestinal tube for babies and infants according to J.Ermisch

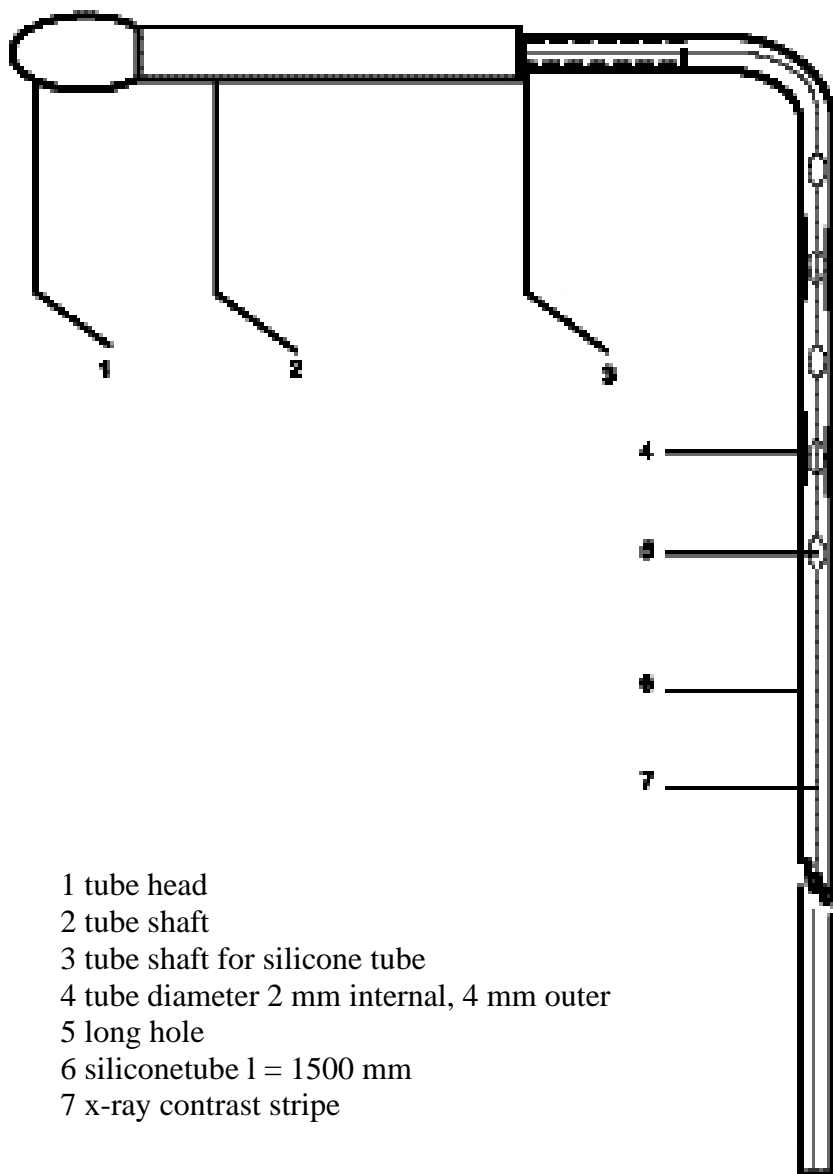

- 1 tube head
- 2 tube shaft
- 3 tube shaft for silicone tube
- 4 tube diameter 2 mm internal, 4 mm outer
- 5 long hole
- 6 siliconetube l = 1500 mm
- 7 x-ray contrast stripe

pict. 2

The selling unit is 2 pieces (article number 200234).

Manufacturer:



Gewerbepark 18
D-08258 Markneukirchen
Tel.: 0049 37422 583-34
Fax: 0049 37422 583-39
E-Mail: catgut@catgut.de
Internet: www.catgut.de

Surgical sutures

Minimal invasive surgery



Minimal Invasive Surgery covers all techniques that use specially developed cameras, optical devices and instruments for surgical interventions in the pelvic, thoracic or groin area, in arthral surgery (e.g. knee joint).

Only very small skin incisions are made. The advantage of this surgical method is to avoid the destruction of tissues on the way toward the real place of the intervention.

Minimal Invasive Surgery develops very fast. In all field of surgery users search ways to use this technique for various indications.

The growing application of minimal invasive technologies lead to a change in the need of sutures. Catgut GmbH offers a number of articles related to this development in addition to the standard suture range.

Sutures for minimal invasive surgery, their main characteristics:

NON-ABSORBABLE:

MONOFILAMENT	POLYFILAMENT
<p>MAPROLEN[®] Polypropylene blue</p> <p>very soft and smooth optimum handling constant thread diameter smooth surface frictionless and soft tissue passing</p>	<p>POLYESTER-S Polyethylenterephthalate, green</p> <p>precision braided, coated high smoothness well to knot high tensile strength</p>
<p>MARIDERM[®] Copolymer Polyamide 6/66, blue</p> <p>optimum skin closure high tensile strength easy to knot</p>	
<p>MARILON[®] Polyvinylidenfluoride, blue</p> <p>absolutely inert high tensile strength small elongation</p>	

SYNTHETIC ABSORBABLE:

MONOFILAMENT	POLYFILAMENT
<p>MARISORB® Poly-p-dioxanone violet</p> <p>tissue acceptance good handling high knot stability for long term wound closure</p> <p>After 6-7 weeks Marisorb retains half of its tensile strength. Complete degradation by hydrolysis is finished after appr. 180 to 210 days.</p>	<p>MARLIN® / MARLIN® II Polyglykolsäure, braided violet or undyed</p> <p>precision braided, coated, smooth soft tissue passing high tensile strength exact knot placing and adjusting</p> <p>The degradation in the body takes place by hydrolysis with very small tissue reaction. After 14 to 16 days remain of the tensile strength and degradation is accomplished after appr. 90 days</p>
<p>PCL PolyCaprolacton-co-Lactid violet</p> <p>coated highest security by high tensile strength stable knot size and knot stability</p> <p>The tensile strength of PCL is reduced by 50 per cent after 45 to 50 days, after about 180 days degradation by hydrolysis is completed.</p>	
<p>MARICRYL® Poly(glykolide-co-caprolacton undyed or violet</p> <p>short time absorbable smooth and soft reduced tissue reaction secure knots</p> <p>Maricryl® suits in particular for wound adaption in a shorter period of time (up to 2 weeks) and whenever the advantages of a monofilament are requested.</p>	

Suture packing options for minimal invasive surgery:

Ligating loops

Ligating loops are available in a long pack with an integrated knot pusher or as Roeder loops. All loops made from braided material are additionally stiffened in order to use them quickly and effectively



Loop sutures

Loop sutures are made from Marlin®, Marisorb®, PCL, Marilon® or Polyester-S green in different lengths. Additional fixation guarantees a strong needle attachment to the loop..



Intracorporeal suture

For intracorporeal knots we offer shorter threads as well as sutures with a pretied loop (starting loop) in the end. In this way you can reduce the amount of work for the first knot in the intracorporeal suturing. Several needles are available as flat needles. The „blackline“ range is characterised by visibility without reflection in the place of surgery and extremely sure positioning in the needle holder.



Extracorporeal suture (Endo suture)

Extracorporeal sutures from Marlin®, Marlin II, Marisorb®, Marilon®, Maprolen® and Polyester have a suture guide and can be used for all standard trocars. The standard length in the long pack is 110 cm.

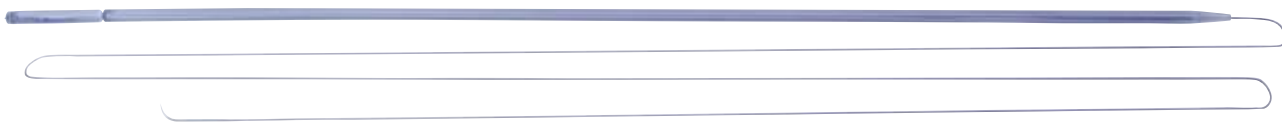

Trocar incision suture

These sutures have a 5/8 circle needle or special incision needles with a prolonged shank. With these sutures you can close fascias very comfortable even if there is only very small place



Needlecode:

1. The first letter indicates the needle shape.

H	=	1/2-circle
D	=	3/8-circle
F	=	5/8-circle
V	=	1/4-circle
K	=	ski-shaped
J	=	90°-50°-asymptotic circle
G	=	straight
T	=	special form for trocar incision

2. The second letter indicates the needle type.

R	=	round body
S	=	cutting
L	=	lancet
I	=	incision needle

3. The third letter indicates special needles.

B	=	black needle (Blackline)
T	=	trocar point
M	=	micro point
S	=	special point
s	=	thick needle
es	=	extra thick needle
d	=	thin needle
f	=	flat needle

4. The number indicates straight needle length in mm.

HR	●	=	1/2-circle, round body, taper point
HRB..f	⊖	=	1/2-circle, flat round body, black (Blackline)
HS	▼	=	1/2-circle, cutting
DR	●	=	3/8-circle, round body, taper point
DRB..f	⊖	=	3/8-circle, flat round body, black (Blackline)
DRC	⊕	=	3/8-circle, round body, cardio point
DS	▼	=	3/8-circle, cutting
FR	●	=	5/8-circle, round body, taper point
GR	●	=	straight, round body, taper point
GS	▼	=	straight, cutting
KR	●	=	ski-shaped, round body, taper point
KS	▼	=	ski-shaped, cutting
TI	⊙	=	special form for trocar incision, trocar point, round body
HRT	⊕	=	1/2-circle, round body, trocar point
DRT	⊕	=	3/8 circle, round body, trocar point
HRM	⊙	=	1/2-circle, round body, micro point
DRM	⊙	=	3/8-circle, round body, micro point
HSM	▼	=	1/2-circle, cutting, micro point
DSM	▼	=	3/8-circle, cutting, micro point
HLM	▼	=	1/2-circle, round body, lancet micro point
DLM	▼	=	3/8-circle, round body, lancet micro point
GLM	▼	=	straight, round body, lancet micro point
JLM	▼	=	90°-50° asymptotic circle, round body, lancet micro point
VLM	▼	=	1/4-circle, round body, lancet micro point
HRN	○	=	1/2-circle, round body, blunt point
DSS	▼	=	3/8-circle, cutting, slim point

Delivery program





Pretied ligating loops

Suture material	Article-No.	Colour	USP	Metric	Length	UoS
MARLIN® PGA, braided, coated, absorbable	17244310	violet	2/0	3	60 cm	12
	17244314	violet	0	3,5	60 cm	12
	17244320	violet	1	4	60 cm	12
	17244322	violet	2	5	60 cm	12
	17244331	violet	0	3,5	90 cm	12
MARLIN® II PGA, braided, coated, absorbable	17294311	violet	2/0	3	60 cm	12
	17294315	violet	0	3,5	60 cm	12
	17294321	violet	1	4	60 cm	12
	17294323	violet	2	5	60 cm	12
MARISORB® Polydioxanon, monofilament absorbable	17304781	violet	0	3,5	60 cm	12
	17304782	violet	1	4	60 cm	12
	17304790	violet	2/0	3	90 cm	12
	17304792	violet	0	3,5	90 cm	12
PCL Poly-(ε-Caprolakton-co-L-Lactid) absorbable	17284666	violet	3/0	2	60 cm	12
	17284670	violet	2/0	3	60 cm	12
	17284674	violet	0	3,5	60 cm	12
	17284679	violet	1	4	60 cm	12
MARILON® PVDF, monofilament non-absorbable	17218768	blue	2/0	3	60 cm	12
	17218776	blue	0	3,5	60 cm	12
MAPROLEN® Polypropylen, monofilament non-absorbable	17405300	blue	2/0	3	90 cm	12

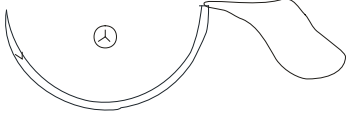

Röder-loops

Suture material	Article-No.	Colour	USP	Metric	Length	UoS
MARLIN® PGA, braided, coated, absorbable	17248351	undyed	2/0	3	60 cm	12
	17248355	undyed	0	3,5	60 cm	12
	17248360	undyed	1	4	60 cm	12
	17248364	undyed	2	5	60 cm	12
MARLIN® rapid PGA, braided, coated, schnell absorbable	17268240	undyed	0	3,5	60 cm	12
	17268244	undyed	1	4	60 cm	12





Loop sutures

Needle description	Suture material	Article-No.	USP	Metric	Length	UoS
 HR 40s	MARLIN [®] violet	17244100	1	4	150 cm	12
	PCL violet	17284200	1	4	150 cm	12
 HR 43s	MARISORB [®] violet	17304222	0	3,5	150 cm	12
	MARISORB [®] violet	17304224	1	4	150 cm	12
	PCL violet	17284270	1	4	150 cm	12
 HR 48s	MARLIN [®] violet	17244220	1	4	150 cm	12
	MARISORB [®] violet	17304340	1	4	150 cm	12
	PCL	17284398	1	4	90 cm	12
	PCL	17284400	1	4	150 cm	12
	PCL	17284404	1	4	180 cm	12
 HRT 43	PCL violet	17284240	1	4	150 cm	12
 HRT 48s	MARISORB [®] violet	17304462	1	4	150 cm	12
	PCL violet	17284262	1	4	150 cm	12
	PCL violet	17284264	1	4	180 cm	12
 DRT 18	MARILON [®] blue	17219450	4/0	1,5	50 cm	12
	Polyester-S green	17219442	4/0	1,5	30 cm	12





Intracorporal suture

Needle description	Suture material	Article-No.	USP	Metric	Length	UoS
 KR 23	MARISORB [®] violet	17303979	3/0	2	20 cm	24
 KS 22	MARLIN [®] violet	17242636	3/0	2	20 cm	24



Pretied Intracorporal suture

Needle description	Suture material	Article-No.	USP	Metric	Length	UoS
 Blackline HRB 22f	MARLIN [®] violet	17248712	3/0	2	15 cm	24
 Blackline DRB 22f	MARLIN [®] violet	17248764	3/0	2	15 cm	24
 GR 19	MARLIN [®] violet	17248800	3/0	2	15 cm	24
 KR 23	MARLIN [®] violet	17248853	4/0	1,5	15 cm	24

Extracorporal suture (Endo suture)

Needle description	Suture material	Article-No.	USP	Metric	Length	UoS
 DR 18	MAPROLEN® blue	17405112	2/0	3	110 cm	12
 GR 19	MARLIN® II violet	17296020	2/0	3	110 cm	12
 GS 30	MARLIN® II violet MARISORB® violet	17296031 17304894	1 0	4 3,5	110 cm 110 cm	12 12
 KR 23	MARLIN® violet MARLIN® II violet MARISORB® violet MARILON® blue MARILON® blue Polyester-S green	17246011 17296016 17304890 17208144 17208146 17208700	2/0 2/0 2/0 0 1 2/0	3 3 3 3,5 4 3	110 cm 110 cm 110 cm 110 cm 110 cm 110 cm	12 12 12 12 12 12
 KS 22	Polyester-S green	17218650	2/0	3	110 cm	12

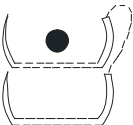
Trocar incision suture

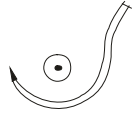
Needle description	Suture material	Article-No.	USP	Metric	Length	UoS
 FR 27	MARLIN [®] violet	17242462	2/0	3	90 cm	24
	MARLIN [®] violet	17242464	0	3,5	90 cm	24
	MARLIN [®] violet	17242465	1	4	90 cm	24
	MARISORB [®] violet	17303880	0	3,5	70 cm	24
 2xFR 27	MARLIN [®] violet	17242468	2/0	3	90 cm	24
 FR 27s	MARLIN [®] violet	17242479	2/0	3	70 cm	24
	MARISORB [®] violet	17303890	2/0	3	70 cm	24
 TI 26	MARLIN [®] violet	17242828	2/0	3	110 cm	24
	MARLIN [®] violet	17242825	0	3,5	90 cm	24

